

Communication Protocol

**EtherCAT®**



for the Optical Plasma Gauges

**Augent® OPG550**

## Table of Contents

General Information	4
Intended Use	4
EtherCAT–Interface	4
Product Identification	4
Validity	5
Trademarks	5
Patents	5
<b>1 Technical Data</b>	<b>6</b>
<b>2 Power Connection</b>	<b>7</b>
2.1 D-sub, 9-pin Connector	7
2.2 RJ45, 8-pin Connector	8
<b>3 Operation</b>	<b>9</b>
3.1 Introduction	9
3.2 Front View	9
3.3 Indicators and Switches	10
3.3.1 <RUN> LED	10
3.3.2 <ERR> LED	10
3.3.3 <LA> LED (<IN> Port)	10
3.3.4 <LA> LED (<OUT> Port)	10
3.3.5 Device Address Switch	11
3.3.6 Life Information LED <LI>	11
3.3.7 Status LED <ST>	12
3.3.8 High Voltage LED <HV>	12
3.3.9 Augent Measurement LED <AM>	12
3.3.10 Firmware Update	12
<b>4 Object Structure OPG550</b>	<b>13</b>
4.1 Object Dictionary structure	13
4.2 Communication Profile Objects (0x1000...0x1FFF)	15
4.2.1 EtherCAT Properties	15
4.2.2 Process Data Mapping (PDO's)	16
4.2.3 Sync Manager	18
4.3 OPG550 Specific Input Area (0x2000...0x2FFF)	18
4.3.1 Common Sensor	18
4.3.2 SPEC	19
4.3.3 ROR	20
4.3.4 RGD	21
4.4 OPG550 Specific Configuration Area (0x4000...0x4FFF)	23
4.4.1 SPEC	23
4.4.2 ROR	24
4.4.3 RGD	26
4.4.4 Common Configuration	28
4.4.5 Operating mode	29
4.5 OPG550 Specific Information Area (0x5000...0x5FFF)	30
4.5.1 ROR	30
4.5.2 RGD	31
4.5.3 Common	32
4.6 ETG.5003 Input Area (0x6000...0x6FFF)	33
4.6.1 Pirani	33
4.6.2 Cold Cathode	34
4.7 ETG.5003 Information Area (0x9000...0x9FFF)	35
4.7.1 SPEC	35
4.7.2 ROR	35
4.7.3 RGD	35
4.7.4 Pirani	36
4.7.5 Cold Cathode	37
4.8 ETG.5003 Device Area (0xF000...0xAFFF)	38
4.8.1 Semiconductor Device Profile	38
4.8.2 Module Profile List	39
4.9 ETG.5003 Exceptions	39
4.9.1 Active Exception Status	39
4.9.2 Active Module Device Exception Details	40
4.9.3 Active Global Device Exception Details	41
4.9.4 Latched Exception Status	41
4.9.5 Latched Module Device Exception Details	41
4.9.6 Latched Global Device Exception Details	41

4.9.7	Device Exception Masks	42
4.10	ETG.5003 Device Specific Profile Objects	42
4.10.1	Vacuum Combination Gauge	42
4.10.2	Input Latch Local Timestamp	43
4.11	ETG.5003 Configure Device	43
4.11.1	Pressure Data Units	43
4.12	ETG.5003 Device Specific Information Data	44
4.12.1	SDP Information Device	44
4.12.2	CDP Information Device	44
4.13	OPG550 Specific Commands	45
4.13.1	HV On/Off Command	45
4.13.2	Algorithm On/Off	45
4.14	ETG.5003 Commands	46
4.14.1	Device Reset Command	46
4.14.2	Exception Reset Command	47
4.14.3	Store Parameters Command	48
4.14.4	Calculate Checksum Command	49
4.14.5	Load Parameters Command	50
<b>Appendix</b>		<b>51</b>
A:	Literature	51
B:	Certificate EtherCAT Conformance Test	52

For cross-references within this document, the symbol (→  XY) is used, for cross-references to further documents, listed under literature, the symbol (→  [Z]).

## General Information

**Caution**

**Data transmission errors**  
 Any attempt to simultaneously operate the gauge via the RS232C Serial Interface and EtherCAT interface or the diagnostic port may result in incorrect data and data transmission errors.  
 Therefore, it is inadmissible to simultaneously operate the gauge via the RS232C Serial Interface and EtherCAT interface, or the diagnostic port.

## Intended Use

This Communication Protocol contains instructions for operating EtherCAT interfaces (slaves) together with a master.



For safety information, specifications and operation instructions of the vacuum gauges refer to Operating Manual tinb84d1 (German) or tinb84e1 (English). Both can be downloaded from our website ([www.inficon.com](http://www.inficon.com)).

## EtherCAT-Interface

The following description of the EtherCAT interface is compliant to the EtherCAT specification of the EtherCAT Technology Group (ETG) and to the "EtherCAT Semiconductor Device Profile".

This manual describes the functionality of an EtherCAT slave and supports

- ETG.5003.1 S (R) V1.1.0: Common Device Profile (CDP) (→ [10]) and
- ETG.5003.2080 S (R) V1.3.0: Semiconductor Device profile – Part 2080: Specific Device Profile (SDP): Vacuum Pressure Gauge (→ [11]).

For operating the gauge via EtherCAT, prior installation of the device specific ESI file is required on the bus master side. This file can be downloaded from our website ([www.inficon.com](http://www.inficon.com)).

## Product Identification

In all communications with INFICON, please specify the information on the product nameplate. For convenient reference copy that information into the space provided below.

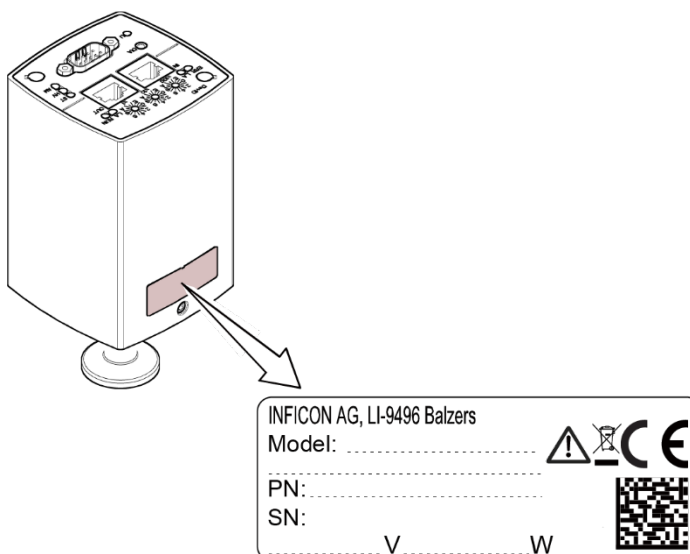

## Validity

This document applies to products of the Augent® OPG550 series with EtherCAT interface.

Part numbers of standard products are indicated below. OEM products have other part numbers and different parameter settings (e.g. factory setting of setpoint) as defined in the corresponding ordering information.

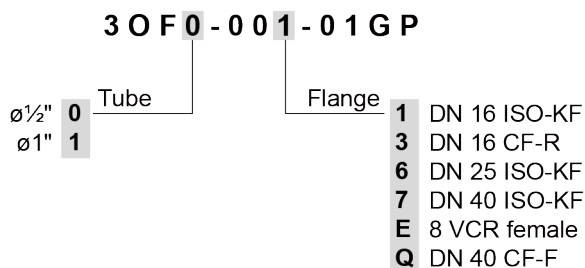

The part number (PN) can be taken from the product nameplate.

If not indicated otherwise in the legends, the illustrations in this document correspond to OPG550 gauges with the DN 25 ISO-KF vacuum connection. They apply to the other gauges by analogy.

We reserve the right to make technical changes without prior notice.

## Trademarks

**EtherCAT®** EtherCAT® is a registered trademark and patented technology, licensed by Beckhoff Automation GmbH, Germany.

**Augent®** INFICON Holding AG

## Patents

EP 1070239 B1, 1040333 B1

US Patents 6528008, 6591687, 7107855, 7140085

# 1 Technical Data



Further technical data → [1]

## Power supply



**DANGER**

The gauge may only be connected to power supplies, instruments, or control devices that conform to the requirements of a grounded protective extra-low voltage (PELV) and limited power source (LPS), Class 2. The connection to the gauge has to be fused.

Supply voltage at the gauge	+14.5 ... +30 V (dc) Class 2 / LPS
Ripple	≤1 V <sub>pp</sub>
Power consumption	≤5 W
Fuse to be connected	1 AT

The minimum voltage of the power supply unit must be increased proportionally to the length of the sensor cable.

Electrical connection	D-sub, 9-pin, male
Sensor cable	7-pin, shielded

## EtherCAT interface

Communication protocol	EtherCAT
Communication standards	ETG.5003.1 S (R) V1.1.0: Part 1 Common Device Profile (CDP)
Data rate	100 Mbps
Node address	Explicit Device Identification
Physical layer	100BASE-Tx (IEEE 802.3)
EtherCAT connector	2 × RJ45, 8-pin (socket) <IN>: EtherCAT input <OUT>: EtherCAT output
Cable	shielded, special Ethernet Patch Cable (CAT5e quality or higher)
Cable length	≤100 m
Process data	Fixed PDO mapping and configurable PDO mapping
Mailbox (CoE)	SDO requests, responses and information

## 2 Power Connection



Make sure the vacuum connection is properly made (→ Operating Manual).



**STOP DANGER**

The gauge may only be connected to power supplies, instruments, or control devices that conform to the requirements of a grounded protective extra-low voltage (PELV) and limited power source (LPS), Class 2. The connection to the gauge has to be fused.



Ground loops, differences of potential, or EMC problems may affect the measurement signal. For optimum signal quality, please do observe the following notes:

- Use an overall metal braided shielded cable. The connector must have a metal case.
- Connect the supply common with protective ground directly at the power.
- Use differential measurement input (signal common and supply common conducted separately).
- Potential difference between supply common and housing  $\leq 6$  V (overvoltage protection).

### 2.1 D-sub, 9-pin Connector

If no sensor cable is available, make one according to the following diagram.

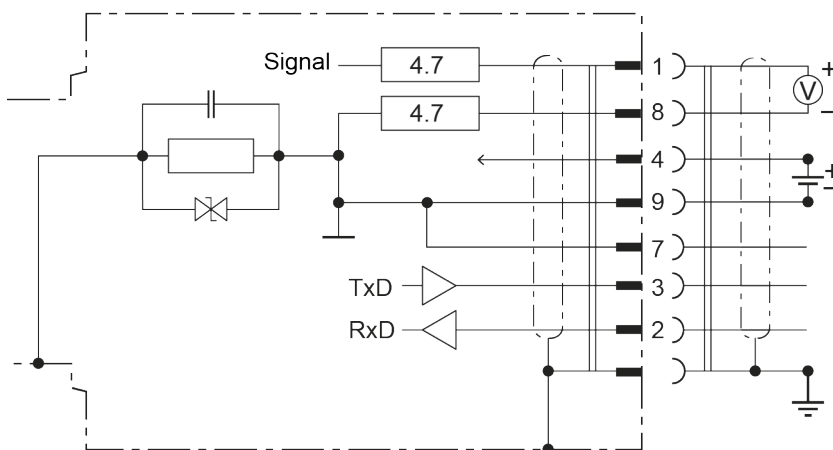

- Pin 1 Signal output (measuring signal)
- Pin 2 RS232, RxD
- Pin 3 RS232, TxD
- Pin 4 Supply (+14.5 ... +30 V dc)
- Pin 5 n.c.
- Pin 6 n.c.
- Pin 7 RS232, GND
- Pin 8 Signal common
- Pin 8 Supply common

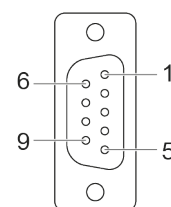

D-sub, 9-pin female soldering side

## 2.2 RJ45, 8-pin Connector

For operating the OPG550 gauges via EtherCAT, at least one cable conforming to the EtherCAT standard are required.

If no sensor cable is available, make one according to the following diagram.

Cable type

Ethernet Patch Cable Cable (CAT5e quality) with RJ45 connector.

Procedure

1 Pin assignment:

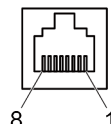
Pin	Signal	Description	
1	TD+	Transmission Data +	 <p>RJ45, 8-pin male soldering side</p>
2	TD-	Transmission Data -	
3	RD+	Receive Data +	
4	nu	not used	
5	nu	not used	
6	RD-	Receive Data -	
7	nu	not used	
8	nu	not used	

2 Plug the EtherCAT (and sensor) cables connector into the gauge: From the previous device the cable connected to OUT port has to be connected to the OPG550 <IN> port. And the cable from the OPG550 <OUT> port has to be connected to the next device's <IN> port.

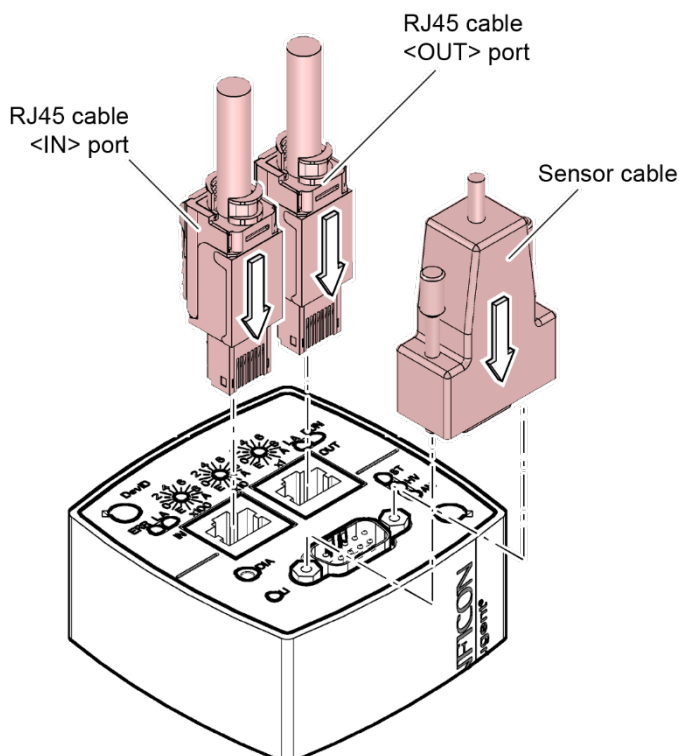



## 3 Operation

### 3.1 Introduction

Via the EtherCAT interface, the following and further data are exchanged in the standardized EtherCAT protocol:

- SPEC, ROR or RGD values
- Pressure reading
- Pressure unit (Torr, mbar, Pa)
- Status and error messages
- Device control commands



#### Caution



Data transmission errors

Any attempt to simultaneously operate the gauge via the RS232C Serial Interface and EtherCAT interface or the diagnostic port may result in incorrect data and data transmission errors.

Therefore, it is inadmissible to simultaneously operate the gauge via the RS232C Serial Interface and EtherCAT interface or the diagnostic port.

### 3.2 Front View

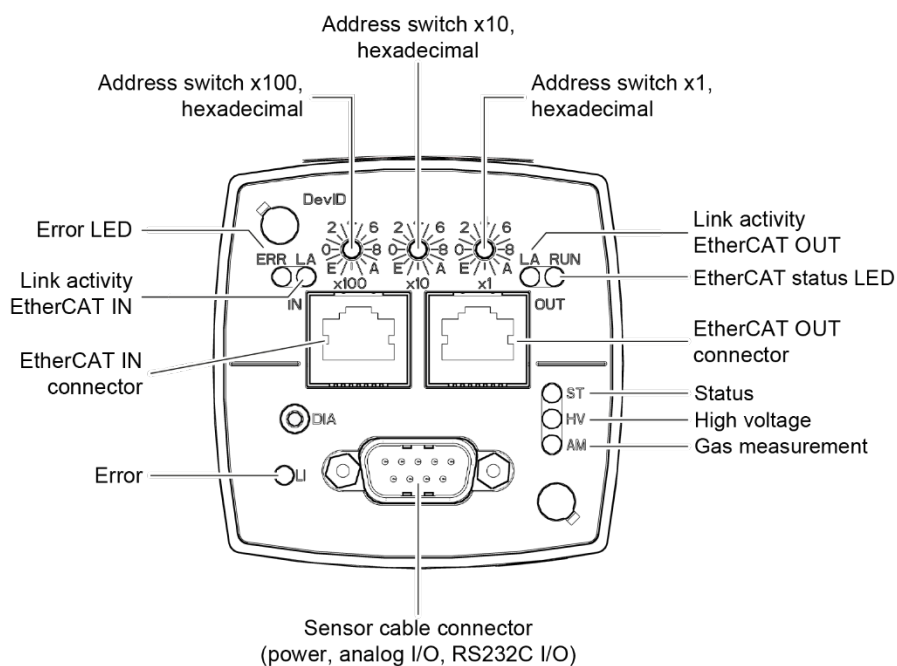

### 3.3 Indicators and Switches

#### 3.3.1 <RUN> LED

Displays the operating status.



Color	LED State	Description
green	off	INIT (initialization status) or no power applied to device.
	blinking (200 ms on 200 ms off)	PREOP (pre-operational status).
	single flash (200 ms on 1000 ms off)	SAFEOP (safe-operational status). Communication of cyclic data transfer running. Input values available, output values written to the device but not updated on device output.
	on	OP (operational status).

#### 3.3.2 <ERR> LED

Displays the error content.



Color	LED State	Description
red	off	No error or no power applied to device.
	blinking (200 ms on 200 ms off)	Error occurred (see error parameter).
	single flash (200 ms on 1000 ms off)	Slave device application has changed the EtherCAT state autonomously, due to local error (see error parameter).
	double flash (200 ms on 200 ms off 200 ms on 1000 ms off)	An application watchdog timeout has occurred. Sync Manager Watchdog timeout or communication timeout occurred.
	on	A critical communication or application controller error has occurred. Application controller is not responding any more (PDI Watchdog Timeout detected by ESC)

#### 3.3.3 <LA> LED (<IN> Port)

Displays the input status.



Color	LED State	Description
green	off	Port not connected or no power applied to device.
	blinking	Port connected and communication active.
	on	Port connected but no communication.

#### 3.3.4 <LA> LED (<OUT> Port)

Displays the output status.



Color	LED State	Description
green	off	Port not connected or no power applied to device.
	blinking	Port connected and communication active.
	on	Port connected but no communication.

### 3.3.5 Device Address Switch

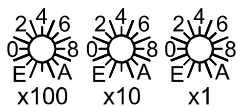

During device initialization, the device address switches are read by the device firmware. This device address is supported to the master as Explicit Device Identification.

Example: Value of the Explicit Device ID = 0xDDD (dec 3549):  
 $0x100 * 0xD$  (dec 3328) +  $0x10 * 0xD$  (dec 208) +  $0x1 * 0xD$  (dec 13)

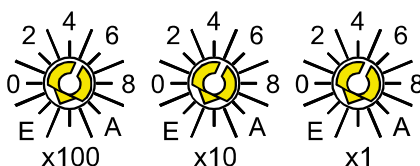

### 3.3.6 Life Information LED <LI>

Displays the main status of the sensor.

Color	LED State	Description
green	on	Operational.
orange	on	Warning: scheduled maintenance soon.
red	on	Device failure.
	blinking	The device is in error status (no communication possible).
	Double flash (200 ms on 200 ms off 200 ms on 1000 ms off)	Application firmware is not valid or firmware update failed.
	Triple flash (200 ms on 200 ms off 200 ms on 200 ms off 200 ms on 1000 ms off)	The device is in error status (communication possible).

During firmware update, the lifetime LED shows up the current progress.

Color	LED State	Description
green/ red	alternating	FW upgrade in progress.
green	on	FW upgrade without version change – nothing done.
	double flash (200 ms on 200 ms off 200 ms on 1000 ms off)	FW upgrade done – reboot required.
red	double flash (200 ms on 200 ms off 200 ms on 1000 ms off)	Application firmware is not valid or firmware update failed.

### 3.3.7 Status LED <ST>

Displays the status of the device.

Color	LED State	Description
green	off	No power applied to device.
	blinking (200 ms on 200 ms off)	The device is starting up.
	double flash (200 ms on 200 ms off 200 ms on 1000 ms off)	The device is in bootloader status.
	on	Application firmware is running.

### 3.3.8 High Voltage LED <HV>

Displays the cold cathode high voltage status.

Color	LED State	Description
green	off	High voltage is off.
	blinking	High voltage is on, but no plasma ignited.
	on	High voltage is on and plasma ignited.

### 3.3.9 Augent Measurement LED <AM>

Displays the gas measurement status.

Color	LED State	Description
blue	off	No spectrum measurement active.
	on	Spectrum measurement active (SPEC, ROR or RGD)

### 3.3.10 Firmware Update

The firmware update can be done via FTP interface via EtherCAT connection. Please ensure to

- user: fwupdate
- password: (empty)

The firmware update progress is indicated at the <LI> LED (chapter 3.3.6).

## 4 Object Structure OPG550

This chapter describes the CANopen over EtherCAT (CoE) Object Dictionary.

### 4.1 Object Dictionary structure

The objects in the CoE Object Dictionary can be accessed with SDO services, and many of the dictionary objects can be mapped for cyclic communication in PDOs. Each object is addressed using a 16-bit index and an 8-bit subindex.

#### Device Description

A device description is available on our website ([www.inficon.com](http://www.inficon.com)).

The GSDML file provides the available SDOs and default PDOs as well as all relevant device specific fieldbus settings.

#### Layout Object Dictionary

The following table presents the overall layout of the standard Object Dictionary.

Index (hex.)	Object dictionary area	
1000 – 1FFF	Communication profile area	
2000 – 2FFF	OPG550 Area	Input area
3000 – 3FFF		Output area
4000 – 4FFF		Configuration area
5000 – 5FFF		Information area
6000 – 6FFF		Input area
7000 – 7FFF	ETG.5003 Profile Specific Area	Output area
8000 – 8FFF		Configuration area
9000 – 9FFF		Information area
A000 – AFFF		Diagnosis area
B000 – BFFF		Service Transfer area
C000 – EFFF		Reserved area
F000 – FFFF		Device area

#### Modular device concept

The device is structured according to the modular device concept into modules. The modules share common hexadecimal digits in the Object Directory:

Index (hex.)	Module
0xX00X	Algorithm SPEC
0xX01X	Algorithm ROR
0xX02X	Algorithm RGD
0xX03X	Pressure Gauge Pirani
0xX04X	Pressure Gauge Cold Cathode

Common elements are mapped in 0X1XX:

Index (hex.)	Module
0xX10X	Device Common

## Abbreviations

Explanations for the abbreviations in the columns of the tables are given below:

Abbr.	Description
Access	SDO read/write access RO: object can only be read by the SDO service RW: object can be both read and written by the SDO service
CoE	CAN application protocol over EtherCAT
Index	Object Index (hex.) (address of an object)
NV	Nonvolatile; attribute value is maintained through power cycles
Object	Abstract representation of a particular component within a device, which consists of data, parameters, and methods.
PDO	Process Data Object. Structure described by mapping parameters containing one or several process data entities.
PM	PDO mapping Rx: object can be mapped into an Rx PDO Tx : object can be mapped into a Tx PDO
SDO	Service Data Objects. CoE asynchronous mailbox communications where all objects in the Object Dictionary can be read and written.
SI	Subindex (hex.) (sub-address of an object)
Type	Data Type BOOL, BIT = 1 bit. Boolean (0 = false, 1 = true) USINT, BYTE = 8 bit. Unsigned Byte UINT = 16 bit. Unsigned integer value UDINT = 32 bit. Unsigned integer value ULINT = 64 bit. Unsigned integer value REAL = 32 bit. Floating point V_STRING = 8×n bit. Visible string (1 byte for character)
RxPDO	Receive PDO. A Process Data Object received by an EtherCAT slave.
TxPDO	Transmit PDO. A Process Data Object sent from an EtherCAT slave.
SPEC	Spectrum The SPEC measuring type measures the gas emission spectrum with a manually set integration time. At the beginning of the measurement, the background spectrum is automatically recorded and then subtracted from the measured spectrum.
ROR	Leak Detection (RoR – Rate of Rise) The RoR measurement type measures the effective gas emission spectrum and characterizes the outgassing behavior of a vacuum chamber during a pressure rise measurement.
RGD	Residual Gas Detection The RGD measuring type measures a signal-to-noise optimized gas emission spectrum and detects gas types and measures gas partial pressures.

## 4.2 Communication Profile Objects (0x1000...0x1FFF)

This chapter describes the basic EtherCAT communication objects covered by the EtherCAT standard.

### 4.2.1 EtherCAT Properties

The objects of the communication profile describe the basic EtherCAT properties of the OPG550 and are common to all EtherCAT slaves using the CoE communication protocol. The objects are described in following table:

Index	SI	Data Type	NV	Access	PM	Name
0x1000		UDINT		RO		Device Type
0x1008		STRING		RO		Manufacturer Device name
0x1009		STRING		RO		Manufacturer Hardware Version
0x100A		STRING		RO		Manufacturer Software Version
0x100B		STRING		RO		Manufacturer Bootloader Version
0x1010	0x01	UDINT		RW		<p>Store Parameters</p> <p>Read: Bit 0 = 1: slave saves the backup entries when writing 0x1010:01 with 0x65766173</p> <p>Bit 1 = 1: slave saves the backup entries automatically when they are written</p> <p>Bit 2-31 = 0</p> <p>Write: With the value 0x65766173 the backup entries will be stored to non-volatile memory of the slave</p>
0x1011	0x01	UDINT		RW		<p>Restore Default Parameters</p> <p>Read: Bit 0 = 1: slave supports the restoring of backup entries with the default values when writing 0x1011:01 with 0x64616F6C Bit 1-31 = 0</p> <p>Write: With the value 0x64616F6C the backup entries will be restored with the default values</p>
0x1018				RO		Identity Object
	0x01	UDINT		RO		Vendor ID
	0x02	UDINT		RO		Product Code
	0x03	UDINT		RO		Revision Number
	0x04	UDINT		RO		Serial Number
0x10F8		ULINT		RO		Timestamp Object

## 4.2.2 Process Data Mapping (PDO's)

The sensor provides a default PDO mapping of the most important process data. There are some PDO groups predefined:

- 0x1A00: SPEC
- 0x1A02: ROR
- 0x1A04: RGD
- 0x1A06: Combo Pressure Gauge
- 0x1BFE: Sensor Status

In scope of ETG.5003.1, TxPDO's 1A01, 1A03, 1A05, 1A07, 1BFF and the RxPDO 1601 are designated for user mapping. These PDO's do not have default values and can be set up by the PDO configuration.

### RxPDO

There are no objects mapped to RxPDO.

Index	SI	Data Type	Access	Value	Name
0x1600		PM	RW		Receive PDO Mapping,
0x1601		PM	RW		Receive PDO Mapping, User Mapping

### TxPDO SPEC

The SPEC measuring type measures the gas emission spectrum with a manually set integration time.



Further technical data → [1]

The mapped signals are described in chapter 4.3.2.

Index	SI	Data Type	Access	Value	Name
0x1A00		PM	RW		SPEC TxPDO Mapping
	0x01	BIT		0x2802:01	Reading Valid
	0x02	BIT7		0x2802:02	Reserved (padding 7 bit)
	0x03	UDINT		0x2802:03	Timestamp
	0x04	USINT		0x2802:04	Algorithm Status
	0x05	USINT		0x2800:01	Ignition Status
	0x06	UDINT		0x2802:05	Integration Time
	0x07 ... 0x10	REAL		0x2802:06 ... 0x2802:0F	Spectrum Power of Wavelength 1 to 10
0x1A01		PM	RW		SPEC TxPDO Mapping, User Mapping



## TxPDO ROR

The ROR measurement type measures the effective gas emission spectrum and characterizes the outgassing behavior of a vacuum chamber during a pressure rise measurement.



Further information → [1]

The mapped signals are described in chapter 4.3.3.

Index	SI	Data Type	Access	Value	Name
0x1A02		PM	RW		ROR TxPDO Mapping
	0x01	BIT		0x2803:01	Reading Valid
	0x02	BIT7		0x2803:02	Reserved (padding 7 bit)
	0x03	UDINT		0x2803:03	Timestamp
	0x04	USINT		0x2803:04	Algorithm Status
	0x05	USINT		0x2800:01	Ignition Status
	0x06	UDINT		0x2803:05	Integration Time
	0x07 ... 0x10	UINT		0x2803:06 ... 0x2803:0F	Spectrum Intensity of Wavelength 1 to 10
	0x11 ... 0x1a	REAL		0x2803:10 ... 0x2803:19	Leak Rate Number of Gas Number 1 to 10
0x1A03		PM	RW		ROR PDO Mapping, User Mapping

## TxPDO RGD

The RGD measuring type measures a signal-to-noise optimized gas emission spectrum and detects gas types, detects gas types and measures gas partial pressures.



Further information → [1]

The mapped signals are described in chapter 4.4.3.

Index	SI	Data Type	Access	Value	Name
0x1A04		PM	RW		RGD TxPDO Mapping
	0x01	BIT		0x2804:01	Reading Valid
	0x02	BIT7		0x2804:02	Reserved (padding 7 bit)
	0x03	UDINT		0x2804:03	Timestamp
	0x04	USINT		0x2804:04	Algorithm Status
	0x05	USINT		0x2800:01	Ignition Status
	0x06	UDINT		0x2803:05	Integration Time
	0x07 ... 0x10	REAL		0x2804:06 ... 0x2804:0F	Spectrum Power of Wavelength 1 to 10
	0x11 ... 0x1A	REAL		0x2804:0F ... 0x2804:18	Gas Intensity of Gas Number 1 to 10
	0x1B ... 0x24	REAL		0x2804:19	Gas Partial Pressure of Gas Number 1
	0x25 ... 0x2E	REAL		0x2804:23 ... 0x2804:32	Ratio Number 1 to 10
0x1A05		PM	RW		RGD TxPDO Mapping, User Mapping

## TxPDO Combo Pressure Gauge

The gauge consists of two separate measuring systems (the Pirani and the cold cathode system according to the inverted magnetron principle). They are combined for the user providing one main pressure value.

The mapped signals are defined according to ETG.5003 and described in chapter 4.10.1.

Index	SI	DataType	Access	Value	Name
0x1A06		PM	RW		Pressure TxPDO Mapping
	0x01	BIT		0xF640:01	Reading Valid
	0x02	BIT		0xF640:02	Overrange Exceeded
	0x03	BIT		0xF640:03	Underrange Exceeded
	0x04	BIT5		0xF640:04	Reserved (padding 5 bit)
	0x05	REAL		0xF640:0B	Combo Pressure Value
	0x06	UINT		0xF640:0C	Combo Active Sensor
0x1A07		PM	RW		Pressure TxPDO Mapping, User Mapping

## TxPDO Sensor Status

The gauge provides the sensor status according to ETG.5003. These signals are described in chapter 4.9.

Index	SI	DataType	Access	Value	Name
0x1BFE		PM	RW		TxPDO Mapping
	0x01	BYTE		0xF380:00	Active Exception Status
0x1BFF		PM	RW		TxPDO Mapping User Mapping

## 4.2.3 Sync Manager

Index	SI	DataType	NV	Access	PM	Name
0x1C00	0x01 0x02 0x03 0x04	BYTE		RW		Sync Manager Type
0x1C12 / 0x1C13	0x01 0x02 0x03 0x04	UINT		RW		Sync Manager PDO Assignment
0x1C32 / 0x1C33	0x01 - 0x20			RW		Sync Manager Parameter

## 4.3 OPG550 Specific Input Area (0x2000...0x2FFF)

This chapter describes the input area for objects specific for OPG550 not covered by the device profiles of ETG.5003.

### 4.3.1 Common Sensor

Index	SI	DataType	NV	Access	PM	Name
0x2800						COMMON: Input
	0x01	USINT		RO	TX	Ignition Status
	0x02	USINT		RO	TX	Self Diagnostic Status

#### Subindex 0x01

Ignition Status	
0	OFF
1	Plasma ON but not ignited yet.
2	Plasma ON and ignited.

Subindex 0x02

Self Diagnostic Status	
0	OK
1	Service soon
2	Device failure

### 4.3.2 SPEC

The SPEC measuring type measures the gas emission spectrum with a manually set integration time.



Further information → [1]

The device allows to output the spectrum power of up to 10 user defined wavelengths on EtherCAT. These wavelengths can be configured by SDO elements 0x4001:0x00.

Index	SI	Data Type	NV	Access	PM	Name
0x2801						SPEC: Input
	0x01	BOOL		RO	TX	Reading Valid
	0x02	BOOL[7]		RO	TX	Reserved
	0x03	UDINT		RO	TX	Timestamp
	0x04	USINT		RO	TX	Algorithm Status
	0x05	UDINT		RO	TX	Integration Time
	0x06 to 0x0F	REAL		RO	TX	Spectrum Power of Wavelength 1 to 10

Subindex 0x01

Reading Valid	
0	Invalid
1	Valid: the values of following subindexes include valid values.

Subindex 0x02

Reserved: always 0.

Subindex 0x03

Timestamp: the relative time from start of the measurement in [ms].

Subindex 0x04

SPEC Algorithm Status	
0	Not selected
1	Idle
2	Setup
3	Background capture
4	Spectrum capture
5	Cleanup
255	Error

Subindex 0x05

Integration Time: Optical integration time in [µs].

Subindex 0x06 to 0x0F

Spectrum Power of Wavelength 1 to 10: raw measured value by the SPEC measuring type.

The related wavelength can be configured by SDOs elements 0x4001:0x00.

### 4.3.3 ROR

The ROR measurement type measures the effective gas emission spectrum and characterizes the outgassing behavior of a vacuum chamber during a pressure rise measurement.

Further information → [1]

The device allows to output the spectrum intensity of up to 10 user defined wavelengths on EtherCAT. These wavelengths can be configured by SDO elements 0x4011:0x00.

The device allows to output the ROR leak rate numbers (formerly named Augent Numbers) of up to 10 user defined gases on EtherCAT. These gases can be configured by SDO elements 0x4012:0x00.

Index	SI	Data Type	NV	Access	PM	Name
0x2802						ROR: Input
	0x01	BOOL		RO	TX	Reading Valid
	0x02	BOOL[7]		RO	TX	Reserved
	0x03	UDINT		RO	TX	Timestamp
	0x04	USINT		RO	TX	Algorithm Status
	0x05	UDINT		RO	TX	Integration Time
	0x06 to 0x0F	UINT		RO	TX	Spectrum Intensity of Wavelength 1 to 10
	0x10 to 0x19	REAL		RO	TX	Leak Rate Number of Gas Number 1 to 10

Subindex 0x01

Reading Valid	
0	Invalid
1	Valid: the values of following subindexes include valid values.

Subindex 0x02

Reserved: always 0.

Subindex 0x03

Timestamp: the relative time from start of the measurement in [ms].

Subindex 0x04

ROR Algorithm Status	
0	Not selected
1	Idle
2	Setup
3	Spectrum capture
4	Cleanup
255	Error

Subindex 0x05

Integration Time: Optical integration time in [µs].

Subindex 0x06 to 0x0F

Spectrum Intensity of Wavelength 1 to 10: raw measured value by the ROR measuring type.

The related wavelengths can be configured by SDOs elements 0x4011:0x00.

Subindex 0x10 to 0x19

Leak Rate Number of Gas Number 1 to 10: output by the ROR measuring type.

The related gas indexes can be configured by SDOs elements 0x4012:0x00.

### 4.3.4 RGD

The RGD measuring type measures a signal-to-noise optimized gas emission spectrum and detects gas types, detects gas types and measures gas partial pressures.



Further information → [1]

The device allows to output the spectrum powers of up to 10 user defined wavelengths on EtherCAT. These wavelengths can be configured by SDO elements 0x4021:0x00.

The device allows to output the gas intensities and the gas partial pressures of up to 10 user defined gases on EtherCAT. These gases can be configured by SDO elements 0x4022:0x00.

The device allows to output the ratio information of up to 10 user defined ratio indexes on EtherCAT. These ratios can be configured by SDO elements 0x4023:0x00.

Index	SI	DataType	NV	Access	PM	Name
0x2803						RGD: Input
	0x01	BOOL		RO	TX	Reading Valid
	0x02	BOOL[7]		RO	TX	Reserved
	0x03	UDINT		RO	TX	Timestamp
	0x04	USINT		RO	TX	Algorithm Status
	0x05	UDINT		RO	TX	Integration Time
	0x06 to 0x0F	REAL		RO	TX	Spectrum Power of Wavelength 1 to 10
	0x10 to 0x19	REAL		RO	TX	Gas Intensity of Gas Number 1 to 10
	0x1A to 0x23	REAL		RO	TX	Gas Partial Pressure of Gas Number 1 to 10
	0x24 to 0x2D	REAL		RO	TX	Ratio Number 1 to 10

Subindex 0x01

Reading Valid	
0	Invalid
1	Valid: the values of following subindexes include valid values.

Subindex 0x02

Reserved: always 0.

Subindex 0x03

Timestamp: the relative time from start of the measurement in [ms].

Subindex 0x04

RGD Algorithm Status	
0	Not selected
1	Idle
2	Setup
3	Background capture
4	Spectrum capture
5	Cleanup
255	Error

Subindex 0x05

Integration Time: Optical integration time in [µs].

Subindex 0x06 to 0x0F	<p>Spectrum Power of Wavelength 1 to 10: raw measured value by the RGD measuring type.</p> <p>The related wavelengths can be configured by SDOs elements 0x4021:0x00.</p>
Subindex 0x10 to 0x19	<p>Gas Intensity of Gas Number 1 to 10: output of the RGD measuring type. The whole spectrum is taken into account to get the residual gas intensities.</p> <p>The related gas indexes can be configured by SDOs elements 0x4022:0x00.</p>
Subindex 0x1A to 0x23	<p>Gas Partial Pressure of Gas Number 1 to 10: output of the RGD measuring type. The gas intensities are recalculated as partial pressures.</p> <p>The related gas indexes can be configured by SDOs elements 0x4022:0x00.</p>
Subindex 0x24 to 0x2D	<p>Ratio Number 1 to 10: output of the RGD measuring type. The gas intensities are put into ratios.</p> <p>The related ratio indexes can be configured by SDOs elements 0x4023:0x00.</p>

## 4.4 OPG550 Specific Configuration Area (0x4000...0x4FFF)

This chapter describes the configuration area for objects specific for OPG550 not covered by the device profiles of ETG.5003.

### 4.4.1 SPEC

The SPEC measuring type measures the gas emission spectrum with a manually set integration time.

#### SPEC: Start parameter MANUAL

In MANUAL mode, the operation starts when the user successfully executes the Algo On/Off command (chapter 4.13.2). This mode can be configured with index 0x4101 (see chapter 4.4.5).

Index	SI	DataType	NV	Access	PM	Name
0x4000						SPEC: Start parameter MANUAL
	0x01	UDINT		RW		Number of spectra to capture
	0x02	UDINT		RW		Integration time

#### Subindex 0x01

Number of spectra to capture: defines that the measurement ends after a specific number of spectra.

Value of 0: Endless mode. Algorithm runs till stopped via command "Algorithm ON/OFF" in element 0xFB43 (described in chapter 4.13.2).

#### Subindex 0x02

Integration time: manually set optical integration time for SPEC algorithm in [µs].

#### SPEC: Start parameter AUTO

In AUTO mode, the operation starts under a defined pressure. This mode can be configured with index 0x4101 (see chapter 4.4.5).

Index	SI	DataType	NV	Access	PM	Name
0x4001						SPEC: Start parameter AUTO
	0x02	UDINT	x	RW		Integration time

#### Subindex 0x02

Integration time: manually set optical integration time for SPEC algorithm in [µs].

#### SPEC: Configuration of PDO output

Index	SI	DataType	NV	Access	PM	Name
0x4002	0x00	REAL[10]		RW		SPEC: Configuration Wavelength 1 to 10

#### Index 0x4002

Configuration wavelength 1 to 10: configuration of the wavelength output from the SPEC algorithm.

This configuration is common for the AUTO and MANUAL mode.

## 4.4.2 ROR

The ROR measurement type measures the effective gas emission spectrum and characterizes the outgassing behavior of a vacuum chamber during a pressure rise measurement.

### ROR: Start parameter MANUAL

In MANUAL mode, the operation starts when the user successfully executes the Algo On/Off command (chapter 4.13.2). This mode can be configured with index 0x4101 (see chapter 4.4.5).

Index	SI	Data Type	NV	Access	PM	Name
0x4010						ROR: Start parameter MANUAL
	0x01	UDINT		RW		Number of spectra to capture
	0x03	UINT		RW		Sensitivity gas number

#### Index 0x01

Number of spectra to capture: defines that the measurement ends after a specific number of spectra.

Value of 0: Endless mode. Algorithm runs till stopped via command "Algorithm ON/OFF" in element 0xFB43 (chapter 4.13.2).

#### Index 0x03

Sensitivity gas number: The ROR algorithm detects the integration time for optimizing the measurement for a specific gas information. This index sets the focus to a specific gas.

ROR Sensitivity Gas Number	
0	Whole Spectrum
1	Oxygen 777 nm
2	Argon 812 nm
3	Nitrogen 822 nm
4	Nitrogen 870 nm
5	Nitrogen 337 nm
6	Hydrogen 656 nm

### ROR: Start parameter AUTO

In AUTO mode, the operation starts under a defined pressure. This mode can be configured with index 0x4101 (see chapter 4.4.5).

Index	SI	Data Type	NV	Access	PM	Name
0x4011						ROR: Start parameter AUTO
	0x03	UINT	x	RW		Sensitivity gas number

#### Subindex 0x03

Sensitivity gas number: The ROR algorithm detects the integration time for optimizing the measurement for a specific gas information. This index sets the focus to a specific gas.

ROR Sensitivity Gas Number	
0	Whole Spectrum
1	Oxygen 777 nm
2	Argon 812 nm
3	Nitrogen 822 nm
4	Nitrogen 870 nm
5	Nitrogen 337 nm
6	Hydrogen 656 nm



**ROR: Configuration of PDO output**

Index	SI	Data Type	NV	Access	PM	Name
0x4012	0x00	REAL[10]		RW		ROR: Configuration Wavelength 1 to 10
0x4013	0x00	UINT[10]		RW		ROR: Configuration Gas number 1 to 10

Index 0x4012

Configuration wavelength 1 to 10: configuration of the wavelength output from the ROR algorithm.

Index 0x4012

Configuration gas number 1 to 10: configuration of the gas output from the ROR algorithm.

ROR Configuration Gas Number	
0	Whole Spectrum
1	Oxygen 777 nm
2	Argon 812 nm
3	Nitrogen 822 nm
4	Nitrogen 870 nm
5	Nitrogen 337 nm
6	Hydrogen 656 nm

### 4.4.3 RGD

The RGD measuring type measures a signal-to-noise optimized gas emission spectrum and detects gas types, detects gas types and measures gas partial pressures.

#### RGA: Start parameter MANUAL

In MANUAL mode, the operation starts when the user successfully executes the Algo On/Off command (chapter 4.13.2). This mode can be configured with index 0x4101 (see chapter 4.4.5).

Index	SI	Data Type	NV	Access	PM	Name
0x4020						RGD: Start parameter
	0x01	UDINT		RW		Number of spectra to capture
	0x03	UINT		RW		Sensitivity gas number

#### Subindex 0x01

Number of spectra to capture: defines that the measurement ends after a specific number of spectra.

Value of 0: Endless mode. Algorithm runs till stopped via command "Algorithm ON/OFF" in element 0xFB43 (chapter 4.13.2).

#### Subindex 0x03

Sensitivity gas number: The RGD algorithm detects the integration time for optimizing the measurement for a specific gas information. This index sets the focus to a specific gas.

RGD Sensitivity Gas Number	
0	Whole Spectrum
1	Hydrogen 656 nm
2	Helium 501 nm
3	Nitrogen 337 nm
4	Oxygen 775 nm
5	Argon 809 nm
6	Ammonia 335 nm
7	OH 314 nm
8	CH 431 nm
9	CO 452 nm
10	Fluor 687 nm

### RGD: Start parameter AUTO

In AUTO mode, the operation starts under a defined pressure. This mode can be configured with index 0x4101 (see chapter 4.4.5).

Index	SI	Data Type	NV	Access	PM	Name
0x4021						RGD: Start parameter AUTO
	0x03	UINT	x	RW		Sensitivity Gas number

### Subindex 0x03

Sensitivity Gas number: The RGD algorithm detects the integration time for optimizing the measurement for a specific gas information. This index sets the focus to a specific gas.

RGD Sensitivity Gas Number	
0	Whole Spectrum
1	Hydrogen 656 nm
2	Helium 501 nm
3	Nitrogen 337 nm
4	Oxygen 775 nm
5	Argon 809 nm
6	Ammonia 335 nm
7	OH 314 nm
8	CH 431 nm
9	CO 452 nm
10	Fluor 687 nm

### RGD: Configuration of PDO output

Index	SI	Data Type	NV	Access	PM	Name
0x4022	0x00	REAL[10]		RW		RGD: Configuration Wavelength n
0x4023	0x00	UINT[10]		RW		RGD: Configuration Gas number n
0x4024	0x00	UINT[10]		RW		RGD: Configuration Ratio number n

Index 0x4022

Configuration wavelength 1 to 10: configuration of the wavelength output from the RGD algorithm.

Index 0x4023

Configuration gas number 1 to 10: configuration of the gas output from the RGD algorithm.

RGD Configuration Gas Number	
1	Hydrogen 656 nm
2	Helium 501 nm
3	Nitrogen 337 nm
4	Oxygen 775 nm
5	Argon 809 nm
6	Ammonia 335 nm
7	OH 314 nm
8	CH 431 nm
9	CO 452 nm
10	Fluor 687 nm

Index 0x4024

Configuration Ratio number 1 to 10: configuration of the ratio output from the RGD algorithm.

RGD Configuration Ratio Number	
1	391 nm N2+ vs 311nm OH
2	336 nm N2 vs 311nm OH
3	391 nm N2+ vs 656 nm H
4	336 nm N2 vs 656 nm H
5	391 nm N2+ vs 810 nm Ar
6	777 nm O vs 810 nm Ar
7	502 nm He vs 336 nm N2
8	777 nm O vs 336 nm N2
9	656 nm H vs 777 nm O
10	656 nm H vs 810 nm Ar

### 4.4.4 Common Configuration

Index	SI	Data Type	NV	Access	PM	Name
0x4100	0x00	USINT	x	RW		Plasma Interlock

Subindex 0x4100:0x00

Plasma Interlock: Command to switch off the plasma interlock of the cold cathode.

If enabled, the sensor automatically switches the plasma off if the vacuum pressure is too high. It is not recommended to switch off the plasma interlock due to lifetime considerations.

Plasma interlock	
0	No plasma interlock
1	Plasma is switched off at too high pressure (default)

## 4.4.5 Operating mode

Index	SI	Data Type	NV	Access	PM	Name
0x4101						Operating mode
	0x01	USINT	x	RW		Mode
	0x02	REAL	x	RW		Pressure trip point limit
	0x03	REAL	x	RW		Pressure trip point hysteresis percent

### Subindex 0x01

Mode: This configuration selects if the algorithms start automatically when a given pressure is reached or manually by executing the Algorithm On/Off command (chapter 4.13.2).

Mode	
0	Manual
1	Automatic SPEC
2	Automatic ROR
3	Automatic RGA

### Subindex 0x02

Pressure trip point limit: Configuration for the automatic modes. In automatic mode, the algorithm automatically starts when the pressure is below this configured pressure value.

The pressure data unit is configured by index 0xF840 (see chapter 4.11.1).

### Subindex 0x03

Pressure trip point hysteresis: In automatic mode, the algorithm switches off if the pressure value is above the pressure this point limit plus this hysteresis. The trip point hysteresis is defined in percent of the Trip Point Limit.

## 4.5 OPG550 Specific Information Area (0x5000...0x5FFF)

This chapter describes the information area for objects specific for OPG550 not covered by the device profiles of ETG.5003.

### 4.5.1 ROR

#### ROR: Gas information

The ROR algorithm got an enumeration of gases used to configure the sensor. This enumeration can be programmatically accessed via following elements.

Index	SI	DataType	NV	Access	PM	Name
0x5010	0x00	UINT		RO		ROR: Number of gases
0x5011	0x00	UINT		RW		ROR: Enum Gas number
0x5012						ROR: Enum Gas information
	0x01	STRING[32]		RO		Description
	0x02	REAL		RO		Wavelength

The enumeration will result in following table. The definition might be extended in future SW versions.

ROR Sensitivity Gas Number	
0	Whole Spectrum
1	Oxygen 777 nm
2	Argon 812 nm
3	Nitrogen 822 nm
4	Nitrogen 870 nm
5	Nitrogen 337 nm
6	Hydrogen 656 nm

The index 0 means that the sensor is sensitive to the whole spectrum, this is reserved for element "Sensitivity Gas Number".

Index 0x5010

Number of gases: highest index of enumeration (6).

Index 0x5011

Enum Gas Number: Changing this number will change the information output on 0x5012:0x01 and 0x5012:0x02.

Subindex 0x5012:0x01

Description: Description of the gas.

Subindex 0x5012:0x02

Wavelength: Informative wavelength in [nm].

## 4.5.2 RGD

### RGD: Gas information

This enumeration can be programmatically accessed via following elements.

Index	SI	Data Type	NV	Access	PM	Name
0x5020	0x00	UINT		RO		RGD: Number of gases
0x5021	0x00	UINT		RW		RGD: Enum Gas number
0x5022						RGD: Enum Gas information
	0x01	STRING[32]		RO		Description
	0x02	REAL		RO		Wavelength

The enumeration will result in following table. The definition might be extended in future SW versions.

RGD Gas Number	
0	Whole Spectrum
1	Hydrogen 656 nm
2	Helium 501 nm
3	Nitrogen 337 nm
4	Oxygen 775 nm
5	Argon 809 nm
6	Ammonia 335 nm
7	OH 314 nm
8	CH 431 nm
9	CO 452 nm
10	Fluor 687 nm

The index 0 means that the sensor is sensitive to the whole spectrum, this is reserved for element "Sensitivity Gas Number".

Index 0x5020

Number of gases: highest index of enumeration (10).

Index 0x5021

Enum Gas Number: Changing this number will change the information output on 0x5022:0x01 and 0x5022:0x02.

Subindex 0x5022:0x01

Description: Informative description of the gas.

Subindex 0x5022:0x02

Wavelength: Informative wavelength in [nm].

## RGD: Ratio information

The RGD algorithm got an enumeration of ratios used to configure the sensor. This enumeration can be programmatically accessed via following elements.

Index	SI	Data Type	NV	Access	PM	Name
0x5023	0x00	UINT		RO		RGD: Number of ratios
0x5024	0x00	UINT		RW		RGD: Enum Ratio number
0x5025						RGD: Enum Ratio information
	0x01	STRING[32]		RO		Description

The enumeration will result in following table. The definition might be extended in future SW versions.

RGD Ratio Number	
1	391 nm N2+ vs 311 nm OH
2	336 nm N2 vs 311 nm OH
3	391 nm N2+ vs 656 nm H
4	336 nm N2 vs 656 nm H
5	391 nm N2+ vs 810 nm Ar
6	777 nm O vs 810 nm Ar
7	502 nm He vs 336 nm N2
8	777 nm O vs 336 nm N2
9	656 nm H vs 777 nm O
10	656 nm H vs 810 nm Ar

Index 0x5023

Number of ratios: highest index of enumeration (10).

Index 0x5024

Ratio Number: Changing this number will change the information output on 0x5025:0x01.

Subindex 0x5025:0x01

Description: Informative description of the ratio.

## 4.5.3 Common

### Pixel Information

These elements provide basic information for the spectrometer.

Index	SI	Data Type	NV	Access	PM	Name
0x5100	0x00	UINT		RO		Spectrometer: Number of pixels
0x5101	0x00	UINT		RW		Spectrometer: Start pixel number
0x5102	0x00	REAL[10]		RO		Spectrometer: Wavelength

Index 0x5100

Number of pixels: Number of pixels of the spectrometer (288).

Index 0x5101

Start pixel number: Changing this number will change the information output on 0x5102 and 0x5103. There is a slot of 10 returned wavelengths with the start index defined in 0x5101.

Index 0x5102

Wavelength of the related spectrometer pixels in [nm].



## 4.6 ETG.5003 Input Area (0x6000...0x6FFF)

This chapter describes the input area for objects covered by the device profiles of ETG.5003.

### 4.6.1 Pirani

The included Pirani sensor can be accessed separately. But it is recommended to use the Combo Pressure Gauge output on 0xF640 in chapter 4.10.1.

#### Pirani: Input Common

Index	SI	Data Type	NV	Access	PM	Name
0x6030						Pirani: Input Common
	0x0E	BOOL		RO	TX	TxPdoState
	0x11	REAL		RO	TX	Sensor Value

#### Subindex 0x0E

Is set if the device is not in Safe State (value (I 0x6nn0, SI 0x11) = valid)

TxPdoState	
0	Safe state
1	Actual value

#### Subindex 0x11

The corrected, converted, calibrated pressure value of the sensor.

#### Pirani: Pressure Value

Index	SI	Data Type	NV	Access	PM	Name
0x6033						Pirani: Value
	0x01	BOOL		RO	TX	Reading Valid
	0x02	BOOL		RO	TX	Overrange Exceeded
	0x03	BOOL		RO	TX	Underrange Exceeded

#### Subindex 0x01

Indicates whether the value parameter contains a valid value within the specified accuracy or not.

Reading Valid	
0	Invalid
1	Valid

#### Subindex 0x02

Indicates whether the Value parameter contains a value in over range.

Overrange Exceeded	
0	No Overrange Exceeded
1	Overrange Exceeded

#### Subindex 0x03

Indicates whether the value parameter contains a value in under range.

Underrange Exceeded	
0	No Underrange Exceeded
1	Underrange Exceeded

## 4.6.2 Cold Cathode

The included Cold Cathode sensor can be accessed separately. But it is recommended to use the Combo Pressure Gauge output on 0xF640 in chapter 0.

### Cold Cathode: Input Common

Index	SI	DataType	NV	Access	PM	Name
0x6040						Cold Cathode: Input Common
	0x0E	BOOL		RO	TX	TxPdoState
	0x11	REAL		RO	TX	Sensor Value

#### Subindex 0x0E

Is set if the device is not in Safe State (value (I 0x6nn0, SI 0x11) = valid)

TxPdoState	
0	Safe state
1	Actual value

#### Subindex 0x11

The corrected, converted, calibrated pressure value of the sensor.

### Cold Cathode: Pressure Value

Index	SI	DataType	NV	Access	PM	Name
0x6044						Cold Cathode: Value
	0x01	BOOL		RO	TX	Reading Valid
	0x02	BOOL		RO	TX	Overrange Exceeded
	0x03	BOOL		RO	TX	Underrange Exceeded
	0x04	BOOL		RO	TX	High Voltage Status Off/On

#### Subindex 0x01

Indicates whether the Value parameter contains a valid value within the specified accuracy or not.

Reading Valid	
0	Invalid
1	Valid

#### Subindex 0x02

Indicates whether the Value parameter contains a value in over range.

Overrange Exceeded	
0	No Overrange Exceeded
1	Overrange Exceeded

#### Subindex 0x03

Indicates whether the Value parameter contains a value in under range.

Underrange Exceeded	
0	No Underrange Exceeded
1	Underrange Exceeded

#### Subindex 0x04

Indicates whether the High Voltage is Off or On.

High Voltage Status Off / On	
0	No High Voltage turned on
1	High Voltage turned on

## 4.7 ETG.5003 Information Area (0x9000...0x9FFF)

This chapter describes the information area for objects covered by the device profiles of ETG.5003.

### 4.7.1 SPEC

#### SPEC Sensor Warnings and Errors

ETG.5003 defines to output sensor warnings and errors per module. These elements output the sensor of algorithm SPEC.

Index	SI	DataType	NV	Access	PM	Name
0x9001						Information Sensor
	0x01	UINT		RO		Sensor Warnings
	0x02	UINT		RO		Sensor Errors

Subindex 0x01

Sensor Warnings	
Bit 0...15	Reserved: always 0

Subindex 0x02

Sensor Errors	
Bit 0	FSM State Error
Bit 1...15	Reserved: always 0

### 4.7.2 ROR

#### ROR Sensor Warnings and Errors

ETG.5003 defines to output sensor warnings and errors per module. These elements output the sensor of algorithm ROR.

Index	SI	DataType	NV	Access	PM	Name
0x9011						Information Sensor
	0x01	UINT		RO		Sensor Warnings
	0x02	UINT		RO		Sensor Errors

Subindex 0x01

Sensor Warnings	
Bit 0...15	Reserved: always 0

Subindex 0x02

Sensor Errors	
Bit 0	FSM State Error
Bit 1...15	Reserved: always 0

### 4.7.3 RGD

#### RGD Sensor Warnings and Errors

ETG.5003 defines to output sensor warnings and errors per module. These elements output the sensor of algorithm RGD.

Index	SI	DataType	NV	Access	PM	Name
0x9021						Information Sensor
	0x01	UINT		RO		Sensor Warnings
	0x02	UINT		RO		Sensor Errors

Subindex 0x01

Sensor Warnings	
Bit 0...15	Reserved: always 0

Subindex 0x02

Sensor Errors	
Bit 0	FSM State Error
Bit 1...15	Reserved: always 0

#### 4.7.4 Pirani

##### Pirani: Measurement Range

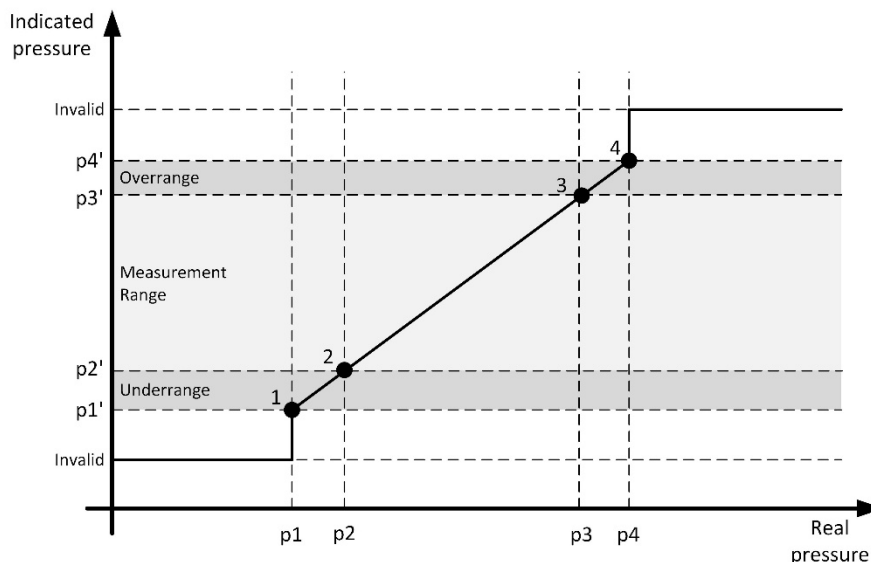

The "measurement range" is the range between minimum and maximum pressure, where the reading of the gauge is within the specified measurement uncertainty limits.

The display range is the complete pressure range where the gauge gives an indication (measurement signal). The display range consists of underrange, measurement range and overrange.

According to these definitions, 4 points are defined:

- 1 Lowest informational measurement value
- 2 Lowest precision measurement value
- 3 Highest precision measurement value
- 4 Highest informational measurement value

Index	SI	DataType	NV	Access	PM	Name
0x9030						Information Common
	0x02	REAL		RO		Highest Informational Measurement Value
	0x03	REAL		RO		Highest Precision Measurement Value
	0x04	REAL		RO		Lowest Precision Measurement Value

Subindex 0x02

Highest Informational Measurement Value: Highest value that the gauge can measure without a specified accuracy.

Subindex 0x03

Highest Precision Measurement Value: Highest valid value at which the gauge is specified with an accuracy value. Above that value, the parameter Reading Valid is set to invalid.

Subindex 0x04

Lowest Precision Measurement Value: Lowest valid value at which the gauge is specified with an accuracy value. Below that value, the parameter Reading Valid is set to invalid.

## Pirani: Sensor Warnings and Errors

ETG.5003 defines to output sensor warnings and errors per module. These elements output of the Pirani sensor.

Index	SI	DataType	NV	Access	PM	Name
0x9031						Information Sensor
	0x01	UINT		RO		Sensor Warnings
	0x02	UINT		RO		Sensor Errors

Subindex 0x01

Sensor Warnings	
Bit 0	Sensor Element Failure
Bit 1	Electronics Warning
Bit 2	Sensor High Temp
Bit 3...15	0

Subindex 0x02

Sensor Errors	
Bit 0	Sensor Element Failure
Bit 1	Electronics Failure
Bit 2	Sensor High Temp
Bit 3...15	0

## 4.7.5 Cold Cathode

### Cold Cathode: Measurement Range

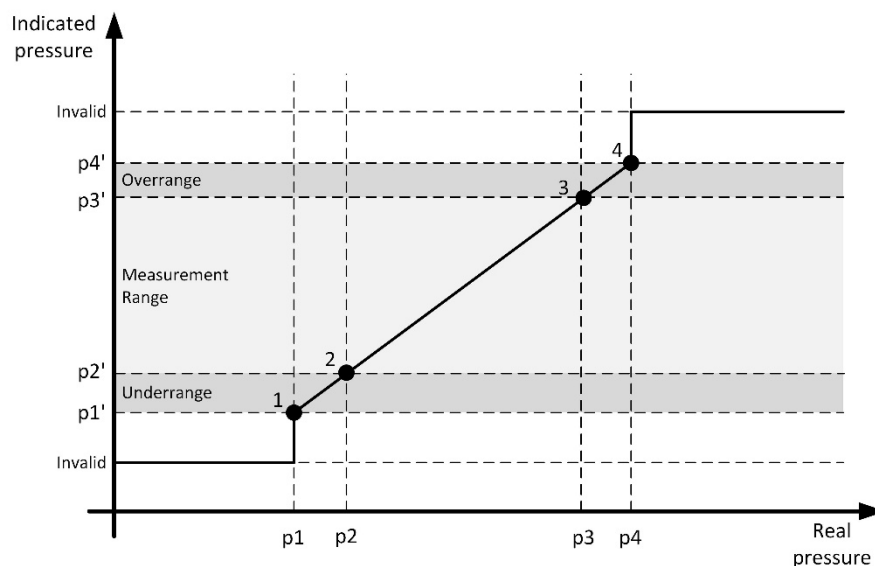

The "measurement range" is the range between minimum and maximum pressure, where the reading of the gauge is within the specified measurement uncertainty limits.

The display range is the complete pressure range where the gauge gives an indication (measurement signal). The display range consists of underrange, measurement range and overrange.

According to these definitions, 4 points are defined:

- 1 Lowest informational measurement value
- 2 Lowest precision measurement value
- 3 Highest precision measurement value
- 4 Highest informational measurement value

Index	SI	DataType	NV	Access	PM	Name
0x9040						Information Common
	0x02	REAL		RO		Highest Informational Measurement Value
	0x03	REAL		RO		Highest Precision Measurement Value
	0x04	REAL		RO		Lowest Precision Measurement Value

#### Subindex 0x02

Highest Informational Measurement Value: Highest value that the gauge can measure without a specified accuracy.

#### Subindex 0x03

Highest Precision Measurement Value: Highest valid value at which the gauge is specified with an accuracy value. Above that value, the parameter Reading Valid is set to invalid.

#### Subindex 0x04

Lowest Precision Measurement Value: Lowest valid value at which the gauge is specified with an accuracy value. Below that value, the parameter Reading Valid is set to invalid.

### Cold Cathode: Sensor Warnings and Errors

ETG.5003 defines to output sensor warnings and errors per module. These elements output the Cold Cathode sensor.

Index	SI	DataType	NV	Access	PM	Name
0x9041						Information Sensor
	0x01	UINT		RO		Sensor Warnings
	0x02	UINT		RO		Sensor Errors

#### Subindex 0x01

Sensor Warnings	
Bit 0	Reserved: always 0
Bit 1	Electronics Warning
Bit 2	Sensor High Temp.
Bit 3...15	Reserved: always 0

#### Subindex 0x02

Sensor Errors	
Bit 0	Reserved: always 0
Bit 1	Electronics Failure
Bit 2	Sensor High Temp.
Bit 3...15	Reserved: always 0

## 4.8 ETG.5003 Device Area (0xF000...0xAFFF)

This chapter describes the device area for objects covered by the device profiles of ETG.5003.

### 4.8.1 Semiconductor Device Profile

Index	SI	DataType	NV	Access	PM	Name
0xF000						Semiconductor Device Profile
	0x01	UINT		RO		Index Distance
	0x02	UINT		RO		Maximum Number of Modules

#### Subindex 0x01

Index Distance: Index offset between PDO entries of two consecutive modules (for ETG.5003 = 0x10).

Subindex 0x02

Maximum Number of Modules: The OPG550 is split into 5 modules:

- SPEC algorithm
- ROR algorithm
- RGD algorithm
- Pirani sensor
- Cold Cathode sensor

The Pirani sensor and Cold Cathode sensor are combined as “Combo Pressure Gauge” in 0xF640.

### 4.8.2 Module Profile List

Index	SI	Data Type	NV	Access	PM	Name
0xF010	0x00	UDINT[5]		RO	TX	Module Profile List

Subindex 0x01 to 0x05

Each sub-index lists the profile-number of the corresponding module.

## 4.9 ETG.5003 Exceptions

This chapter describes the exception area defined by the device profiles of ETG.5003.

The device exceptions are split into warnings where the device is still operational and errors where the device switches off.

The warnings and errors are detailed in registers providing specific errors and warnings.

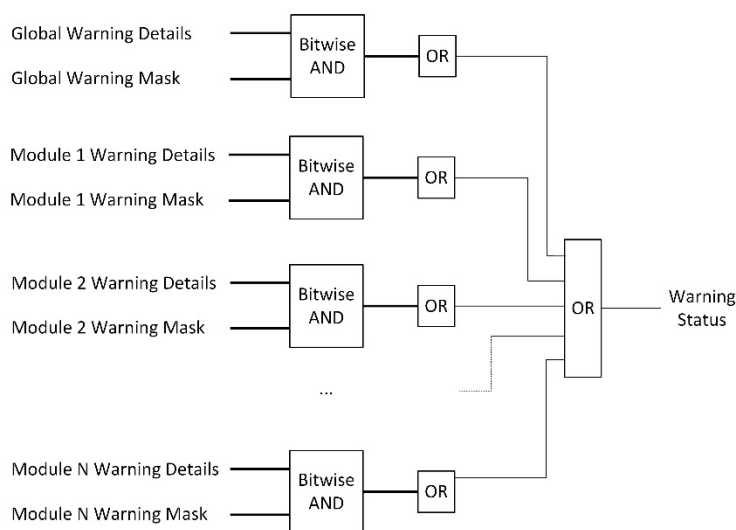

To simplify, the exception module also provides status bits indicating that any bit of these registers is active. The exception masks can be used to mask the detailed registers to be influencing the status bits.

### 4.9.1 Active Exception Status

Index	SI	Data Type	NV	Access	PM	Name
0xF380	0x00	USINT		RO	TX	Active Exception Status

Index 0xF380

Active Exception Status	
Bit 0	Device Warning
Bit 1	Manufacturer Warning (not used)
Bit 2	Device Error
Bit 3	Manufacturer Error (not used)
Bit 4...7	Reserved: always 0

## 4.9.2 Active Module Device Exception Details

Index	SI	Data Type	NV	Access	PM	Name
0xF381	0x00	UDINT[5]		RO	TX	Active Module Device Warning Details
0xF383	0x00	UDINT[5]		RO	TX	Active Module Device Error Details

Subindex 0xF381:0x01

SPEC Algorithm Warnings	
Bit 0...31	Reserved: always 0

Subindex 0xF383:0x01

SPEC Algorithm Errors	
Bit 0	FSM State Error
Bit 1...31	Reserved: always 0

Subindex 0xF381:0x02

ROR Algorithm Warnings	
Bit 0...31	Reserved: always 0

Subindex 0xF383:0x02

ROR Algorithm Errors	
Bit 0	FSM State Error
Bit 1...31	Reserved: always 0

Subindex 0xF381:0x03

RGD Algorithm Warnings	
Bit 0...31	Reserved: always 0

Subindex 0xF383:0x03

RGD Algorithm Errors	
Bit 0	FSM State Error
Bit 1...31	Reserved: always 0

Subindex 0xF381:0x04

Pirani Sensor Warnings	
Bit 0	Sensor Element Warning
Bit 1	Electronics Warning
Bit 2	Sensor High Temp
Bit 3...31	Reserved: always 0

Subindex 0xF381:0x04

Pirani Sensor Errors	
Bit 0	Sensor Element Failure
Bit 1	Electronics Failure
Bit 2	Sensor High Temp
Bit 3...31	Reserved: always 0

Subindex 0xF381:0x05

Cold Cathode Sensor Warnings	
Bit 0	Reserved: always 0
Bit 1	Electronics Warning
Bit 2	Sensor High Temp
Bit 3...31	Reserved: always 0

Subindex 0xF381:0x05

Cold Cathode Sensor Errors	
Bit 0	Reserved: always 0
Bit 1	Electronics Failure
Bit 2	Sensor High Temp
Bit 3...31	Reserved: always 0



### 4.9.3 Active Global Device Exception Details

The active global exceptions detail the warning and error state of the device itself.

Index	SI	Data Type	NV	Access	PM	Name
0xF385	0x01	UDINT		RO	TX	Active Global Device Warning Details
0xF387	0x01	UDINT		RO	TX	Active Global Device Error Details

Index 0xF385

Active Global Device Warning Details	
Bit 0	Reserved: always 0
Bit 1	uP High Temp.
Bit 2...11	Reserved: always 0
Bit 12	Scheduled maintenance soon
Bit 13...31	Reserved: always 0

Index 0xF387

Active Global Device Error Details	
Bit 0...2	Reserved: always 0
Bit 3	EEPROM exception
Bit 4...9	Reserved: always 0
Bit 10	Internal Power supply output voltage error (3.3, 5.0 or 12.0V)
Bit 11	External Power supply output voltage error (24V)
Bit 12	Scheduled maintenance due
Bit 13	Notify vendor
Bit 14...31	Reserved: always 0

### 4.9.4 Latched Exception Status

Index	SI	Data Type	NV	Access	PM	Name
0xF390		USINT		RO	tx	Latched Exception Status

Index 0xF380

Latched Exception Status: Latched version of 0xF380.

### 4.9.5 Latched Module Device Exception Details

Index	SI	Data Type	NV	Access	PM	Name
0xF391	0x00	UDINT[5]		RO	TX	Latched Device Warning Details
0xF393	0x00	UDINT[5]		RO	TX	Latched Device Error Details

Index 0xF391

Latched Device Warning Details: Latched version of 0xF381.

Index 0xF393

Latched Device Error Details: Latched version of 0xF383:01.

### 4.9.6 Latched Global Device Exception Details

Index	SI	Data Type	NV	Access	PM	Name
0xF395	0x01	UDINT		RO	TX	Latched Global Device Warning Details
0xF397	0x01	UDINT		RO	TX	Latched Global Device Error Details

Index 0xF395

Latched Global Device Warning Details: Latched version of 0xF385.

Index 0xF397

Latched Global Device Error Details: Latched version of 0xF387.

#### 4.9.7 Device Exception Masks

Index	SI	DataType	NV	Access	PM	Name
0xF3A1	0x00	UDINT[5]	x	RW		Device Module Warning Mask
0xF3A3	0x00	UDINT[5]	x	RW		Device Module Error Mask
0xF3A5	0x01	UDINT	x	RW		Global Device Warning Mask
0xF3A7	0x01	UDINT	x	RW		Global Device Error Mask

Index 0xF3A1

Device Module Warning Mask: Mask bits for 0xF381 and 0xF391.

Index 0xF3A3

Device Module Error Mask: Mask bits for 0xF383 and 0xF393.

Index 0xF3A5

Global Device Warning Mask: Mask bits for 0xF385:01 and 0xF395:01.

Index 0xF3A7

Global Device Error Mask: Mask bits for 0xF387:01 and 0xF397:01.

Index 0xF3A8

Global Manufacturer Error Mask: Mask bits for 0xF388:01 and 0xF398:01.

#### 4.10 ETG.5003 Device Specific Profile Objects

The manufacturer-specific profile objects contain the manufacturer's data. The objects are described in the following tables.

##### 4.10.1 Vacuum Combination Gauge

Index	SI	DataType	NV	Access	PM	Name
0xF640	0x01	BOOL		RO	tx	Combination Gauge Reading Valid
	0x02	BOOL		RO	tx	Combination Gauge Overrange Exceeded
	0x03	BOOL		RO	tx	Combination Gauge Underrange Exceeded
	0x11	REAL		RO	tx	Combination Gauge Active Value
	0x12	UINT		RO	tx	Combination Gauge Active Sensor Number

Subindex 0x01

Identifies whether the complete vacuum pressure gauge (with several measuring principles) is out of its absolute overrange or absolute underrange, or in any other failure condition.

Subindex 0x02

If the bit "Overrange" is set, all modules of the gauge are in an overrange condition.

Subindex 0x03

If the bit "Underrange" is set, all modules of the gauge are in an underrange condition.

Subindex 0x11

The value copied from the measurement value of the active measuring module used for the Input PDO.

Subindex 0x12

Identifies the module that is providing the measurement value, the latter of which is copied into the Active Value parameter for the Combo Pressure Value.

Active Sensor Number	
0	No module has a valid value
4	Heat Transfer sensor is providing the Active Value
5	Cold Cathode sensor is providing the Active Value

#### 4.10.2 Input Latch Local Timestamp

Index	SI	Data Type	NV	Access	PM	Name
0xF6F0	0x01	UDINT		RO	tx	Input Latch Local Timestamp.
	0x02	UDINT		RO	tx	Input Latch Local Timestamp.

Subindex 0x01

Local controller time corresponding to the input latch time in microseconds. It starts at zero on device power-up. This corresponds the time immediately prior to writing to input SM.

Subindex 0x02

Local controller time corresponding to the input latch time in microseconds. It starts at zero on device power-up. This corresponds the time immediately prior to writing to input SM.

### 4.11 ETG.5003 Configure Device

#### 4.11.1 Pressure Data Units

Index	SI	Data Type	NV	Access	PM	Name
0xF840	0x01	UDINT	x	RW		Data Units
	0x03	USINT	x	RW		Data Units Enum

Subindex 0x01

Unit of the Value of the Pressure Sensor Instance and all related parameters.

Data Units	
0x00220000	Pascal
0xFD4E0000	mbar
0x00A10000	Torr

If this value is changed, also Subindex 2 will change the value accordingly.

Subindex 0x03

Data Unit for Input Sensor as Enum to have a list of possible values.

Data Units	
0x01	Pascal
0x04	mbar
0x05	Torr

If this value is changed, also Subindex 1 will change the value accordingly.

## 4.12 ETG.5003 Device Specific Information Data

### 4.12.1 SDP Information Device

Index	SI	Data Type	NV	Access	PM	Name
0xF940						Information Device
	0x01	UDINT		RO		Measurement Principle
	0x02	USINT		RO		Number of Sensors

Subindex 0x01

Measurement principle assigned to the object instance.

Measurement Principle	
1	Capacitance Manometer
2	Piezo
3	Pirani
4	Cold Cathode
5	Hot Cathode

Subindex 0x02

Number of Sensors: The number of sensors implemented on the device.

This value is 2 because there are a Pirani and Cold Cathode sensor available.

### 4.12.2 CDP Information Device

Index	SI	Data Type	NV	Access	PM	Name
0xF9F0	0x00	STRING[32]		RO		Manufacturer Serial Number
0xF9F1	0x00	UDINT		RO		CDP Functional Generation Number
0xF9F2	0x00	UDINT[5]		RO		SDP Functional Generation Number
0xF9F3	0x00	STRING[32]		RO		Vendor Name
0xF9F4	0x00	STRING[8]		RO		Semiconductor SDP Device Name
0xF9F5	0x00	USINT[5]		RW	RX	Output Identifier
0xF9F6	0x00	UDINT		RO		Time since power on
0xF9F7	0x00	UDINT		RO		Total time powered
0xF9F8	0x00	UDINT		RO		Firmware Update Functional Generation Number

## 4.13 OPG550 Specific Commands

### 4.13.1 HV On/Off Command

Execution of this command will start a high voltage on / off operation.

Index	SI	Data Type	NV	Access	PM	Name
0xFB42	0x01	BYTE[2]		RW		Command
	0x02	BYTE		RO		Status
	0x03	BYTE[3]		RO		Response

#### Subindex 0x01

Command	
Byte 0	0: HV OFF 1: HV ON
Byte 1	5: Index of the Sub Sensor (always 5 for Cold Cathode Sensor)

#### Subindex 0x02

Status (supported values)	
0	Last command completed, no errors, no reply available
1	Last command completed, no errors, reply available
2	Last command completed, errors present, no reply available
3	Last command completed, errors present, reply available
255	Command is executing

#### Subindex 0x03

Response	
Byte 0	See Subindex 0x02
Byte 1	not used = 0x00
Byte 2	0: HV ON/OFF successful 1: HV ON/OFF failed (unspecific reason) 2: HV ON failed because pressure to high 254: No previous HV ON/OFF command issued

### 4.13.2 Algorithm On/Off

Execution of this command will turn on or off the specified algorithm.

Index	SI	Data Type	NV	Access	PM	Name
0xFB43						Algorithm On/Off
	0x01	BYTE[2]		RW		Algorithm On/Off Command
	0x02	BYTE		RO		Algorithm On/Off Status
	0x03	BYTE[3]		RO		Algorithm On/Off Response

#### Subindex 0x01

Command	
Byte 0	0: Algorithm OFF 1: Algorithm ON
Byte 1	0 : SPEC 1: ROR 2: RGD

Subindex 0x02

Status (supported values)	
0	Last command completed, no errors, no reply available
1	Last command completed, no errors, reply available
2	Last command completed, errors present, no reply available
3	Last command completed, errors present, reply available
255	Command is executing

Subindex 0x03

Response	
Byte 0	See Subindex 0x02
Byte 1	not used = 0x00
Byte 2	0: Algorithm ON/OFF successful 1: Algorithm ON/OFF failed (unspecific reason) 254: No previous Algorithm ON/OFF command issued

## 4.14 ETG.5003 Commands

### 4.14.1 Device Reset Command

Execution of this command causes the device to emulate a complete power cycle. This includes an ESC reset. An SDP may limit some behavior of the power cycle emulation, but shall not exclude the EtherCAT interface.



As consequence of an ESC reset all following devices are disconnected from the network.

There are two versions of this command:

- Standard reset (as described above)
- Factory reset (as described above, but additionally, all parameters are restored to as-shipped defaults).

Index	SI	Data Type	NV	Access	PM	Name
0xFBFB0	0x01	BYTE [6]		RW		Command
	0x02	BYTE		RO		Status
	0x03	BYTE[2]		RO		Response

Subindex 0x01

A device reset is initiated when the following byte sequence is sent.

Command	
Byte 0	0x74
Byte 1	0x65
Byte 2	0x73
Byte 3	0x65
Byte 4	0x72
Byte 5	0x00 = Standard reset

Subindex 0x02

Status (supported values)	
0	Reserved
1	Reserved
2	Last command completed, error, no response
3	Reserved
255	Command is executing

Subindex 0x03

Response	
Byte 0	See Subindex 0x02
Byte 1	not used = 0x00

#### 4.14.2 Exception Reset Command

Execution of this command clears the latched exceptions.

Index	SI	Data Type	NV	Access	PM	Name
0xFBF1	0x01	BYTE[5]		RW		Command
	0x02	BYTE		RO		Status
	0x03	BYTE[2]		RO		Response

Subindex 0x01

A device reset is initiated when the following byte sequence is sent.

Command	
Byte 0	0x74
Byte 1	0x65
Byte 2	0x73
Byte 3	0x65
Byte 4	0x72

Subindex 0x02

Status (supported values)	
0	Last command completed, no error, no response
1	Reserved
2	Last command completed, error, no response
3	Reserved
255	Command is executing

Subindex 0x03

Response	
Byte 0	See Subindex 0x02
Byte 1	not used = 0x00

### 4.14.3 Store Parameters Command

Execution of this command will store all parameters to non-volatile memory. If a device automatically saves all non-volatile parameters at the time they are set, this command will not take any action.

Index	SI	Data Type	NV	Access	PM	Name
0xFBF2	0x01	BYTE[4]		RW		Command
	0x02	BYTE		RO		Status
	0x03	BYTE[2]		RO		Response

#### Subindex 0x01

All device parameters are stored when the following byte sequence is sent.

Read:

Command: Read	
Byte 0	0x65
Byte 1	0x76
Byte 2	0x61
Byte 3	0x73

Write:

Command: Write	
Byte 0	0x73
Byte 1	0x61
Byte 2	0x76
Byte 3	0x65

#### Subindex 0x02

Status (supported values)	
0	Last command completed, no error, no response
1	Reserved
2	Last command completed, error, no response
3	Reserved
255	Command is executing

#### Subindex 0x03

Response	
Byte 0	See Subindex 0x02
Byte 1	not used = 0x00



#### 4.14.4 Calculate Checksum Command

Execution of this command will calculate a checksum for all writable, non-volatile parameters as currently stored in non-volatile memory.

Index	SI	Data Type	NV	Access	PM	Name
0xFBF3	0x01	BYTE[4]		RW		Command
	0x02	BYTE		RO		Status
	0x03	BYTE[6]		RO		Response

##### Subindex 0x01

The calculation of the checksum is initiated when the following byte sequence is sent.

##### Read

Command: Read	
Byte 0	Bit 0 = 1: non-volatile parameters supported Bit 1 = 1: CRC-32 Bit 2..7 = 0: not used
Byte 1	not used = 0x00
Byte 2	not used = 0x00
Byte 3	not used = 0x00

##### Write

Command: Write	
Byte 0	Bit 0 = 1: use default checksum algorithm of the slave Bit 1 = 1: CRC-32 Bit 2..7 = 0: not used
Byte 1	not used = 0x00
Byte 2	not used = 0x00
Byte 3	not used = 0x00

##### Subindex 0x02

Status (supported values)	
0	Last command completed, no error, no response
1	Reserved
2	Last command completed, error, no response
3	Reserved
255	Command is executing

##### Subindex 0x03

Response	
Byte 0	See Subindex 0x02
Byte 1	not used = 0
Byte 2	Checksum return value, Byte 0
Byte 3	Checksum return value, Byte 1
Byte 4	Checksum return value, Byte 2
Byte 5	Checksum return value, Byte 3

#### 4.14.5 Load Parameters Command

Execution of this command will load all parameters from non-volatile memory.

Index	SI	DataType	NV	Access	PM	Name
0xFBF4	0x01	BYTE[4]		RW		Command
	0x02	BYTE		RO		Status
	0x03	BYTE[2]		RO		Response

##### Subindex 0x01

The loading is initiated when the following byte sequence is sent.

Read:

Command: Read	
Byte 0	0x64
Byte 1	0x61
Byte 2	0x6F
Byte 3	0x6C

Write:

Command: Write	
Byte 0	0x6C
Byte 1	0x6F
Byte 2	0x61
Byte 3	0x64

##### Subindex 0x02















Status (supported values)	
0	Last command completed, no error, no response
1	Reserved
2	Last command completed, error, no response
3	Reserved
255	Command is executing

##### Subindex 0x03

Response	
Byte 0	See Subindex 0x02
Byte 1	not used = 0x00

## Appendix

### A: Literature

-  [1] Operating Manual OPG550  
tinb84d1 (German)  
tinb84e1 (English)  
INFICON AG, LI-9496 Balzers, Liechtenstein
-  [2] ETG.1000.2: Physical Layer service definition and protocol specification
-  [3] ETG.1000.3: Data Link Layer service definition
-  [4] ETG.1000.4: Data Link Layer protocol specification
-  [5] ETG.1000.5: Application Layer service definition
-  [6] ETG.1000.6: Application Layer protocol specification
-  [7] ETG.1020: EtherCAT Protocol Enhancements
-  [8] ETG.2000: EtherCAT Slave Information
-  [9] ETG.5001.1: Modular Device Profile – Part 1: General MDP Device Model
-  [10] ETG.5003.1 S (R) V1.1.0: Semiconductor Device profile – Part 1: Common Device Profile (CDP)
-  [11] ETG.5003.2080 S (R) V1.3.0: Semiconductor Device profile – Part 2080: Specific Device Profile (SDP): Vacuum Pressure Gauge
-  [12] IEC 61158-x-12 (all parts for type 12): Industrial communication networks – Fieldbus specifications
-  [13] IEC 61784-2: Industrial communication networks – Profiles – Part 2: Additional fieldbus profiles for real-time networks based on ISO/IEC 8802-3
-  [14] SEMI E54 / Draft 5102A: SPECIFICATION FOR SENSOR/ACTUATOR NETWORK SPECIFIC DEVICE MODEL FOR VACUUM PRESSURE GAUGES
-  [15] SEMI E52: Practice for referencing gases, gas mixtures and vaporizable materials used in digital mass flow controllers

**B: Certificate EtherCAT  
Conformance Test**

## Certificate

### EtherCAT Conformance Test

---

## Inficon AG

EtherCAT Technology Group hereby confirms the above named company that the following device is successfully **EtherCAT Conformance Tested**.

**Device under Test**

Product Name:	Augent® OPG550
Product Code:	0x12d
Revision Number:	0x1

Assigned Vendor ID:	0x644
Test Report Number:	0x644_004
EtherCAT Test Center:	Beckhoff Automation, Nuremberg, Germany

**Supported features tested:**

<ul style="list-style-type: none"> <li>✓ Conformance Test Tool 2.5.0.0</li> <li>✓ EtherCAT State Machine</li> <li>✓ Indicator and Labeling</li> <li>✓ Distributed Clocks</li> <li>✓ Explicit Device ID</li> </ul>	<ul style="list-style-type: none"> <li>✓ CoE Mailbox Protocol</li> <li>✓ CiA402 Profile</li> <li>✓ Semi Device Profile</li> </ul>
---	---

Nuremberg, February 15, 2024

---

Martin Rostan, Executive Director  
EtherCAT Technology Group

## Notes

Original: English



1R884E1



*LI-9496 Balzers  
Liechtenstein  
Tel +423 / 388 3111  
Fax +423 / 388 3700  
reachus@inficon.com*

*www.inficon.com*