



Translation of the original operating instructions

HLD6000

Leak detector

Catalog No.

510-025, 510-027, 510-127, 510-028, 510-128

From software version

1.24 or higher (Operating unit)

kinb43en1-05-(2107)



INFICON GmbH
Bonner Strasse 498
50968 Cologne, Germany

Table of Contents

1	About this manual	7
1.1	Other associated documents	7
1.2	Target groups	7
1.3	Warnings	7
2	Safety	8
2.1	Intended use	8
2.2	Owner requirements	9
2.3	Duties of the operator	9
2.4	Dangers	9
3	Shipment, Transport, Storage	11
4	Description	12
4.1	Function	12
4.2	Basic unit	13
4.3	Assembly of the touchscreen	15
4.4	Measurement display elements	18
4.5	Sniffer line	19
4.5.1	Display on the sniffer line	20
4.6	Technical specifications	21
4.7	Factory settings	23
5	Installation	27
5.1	Setup	27
5.2	Sniffer line	27
5.2.1	Connecting the sniffer line	27
5.2.2	Exchanging the sniffer line	28
5.3	Sniffer tip	29
5.3.1	Replacing the sniffer tip	29
5.3.2	Using a water conservation sniffer tip	30
5.3.3	Using flexible sniffer tip	30
5.3.4	Using an extension hose for a sniffer tip	31
5.4	Using calibration leaks	32
5.5	Connecting to the power supply system	32
5.6	Using a USB stick	32

5.7	Connecting a PC.....	33
6	Operation.....	34
6.1	Switch ON.....	34
6.2	Basic settings.....	35
6.2.1	Setting the language.....	35
6.2.2	Setting date and time.....	35
6.2.3	Adjust volume.....	36
6.2.4	Setting auto standby.....	36
6.2.5	Setting the display.....	36
6.2.6	Set time interval for calibration request.....	37
6.2.7	Setting the filter change request.....	38
6.2.8	I/O module.....	38
6.2.8.1	Create a connection between the device and the I/O module.....	38
6.2.8.2	Configuring analog outputs.....	38
6.2.8.3	Setting the upper scale value for 10 V of the analog output.....	39
6.2.8.4	Setting up the I/O module protocol.....	39
6.2.8.5	Configuring digital outputs.....	39
6.2.8.6	Configure digital inputs.....	40
6.2.8.7	Setting the interface unit.....	40
6.2.9	Bus module.....	40
6.2.9.1	Creating a connection between the device and the bus module.....	40
6.2.9.2	Setting a bus module address.....	41
6.2.10	Setup scope of error messages.....	41
6.2.11	Access to the settings.....	41
6.2.11.1	Protecting settings via PIN assign.....	42
6.2.11.2	Switch from supervisor to operator.....	42
6.2.11.3	Switch from operator to supervisor.....	42
6.2.11.4	Changing parameter access controls.....	42
6.2.12	Save parameters.....	43
6.2.13	Load parameters.....	43
6.2.14	Switching the "Screenshot" function on or off.....	43
6.3	Settings for the measurements.....	45
6.3.1	Setting setpoints.....	45
6.3.2	Setting up an alarm profile for setpoints.....	46
6.3.3	Setting up the sniffer probe.....	46
6.3.4	Setting up the gas for the SMART sniffer line.....	46
6.3.5	Verifying R290 with the sniffer line for R600a/R290.....	48
6.3.6	Calibrating.....	48
6.3.6.1	Time and type of calibration.....	48

6.3.6.2	Calibration with an internal COOL-Check	49
6.3.6.3	Calibrate with external calibration leak.....	50
6.3.6.4	Checking the calibration with an internal COOL-Check.....	51
6.4	Measuring.....	52
6.5	Measurement data.....	53
6.5.1	Measurement data recording.....	53
6.5.2	Evaluating measured data	54
6.5.3	Transferring measured data from the internal memory to a USB stick.....	55
6.5.4	Deleting measurement data.....	55
6.6	Standby.....	55
6.7	Diagnosis	55
6.8	Retrieve information about the device	56
6.9	Parameter list.....	57
6.10	Resetting to factory settings	59
6.11	Updating the software.....	59
6.11.1	Updating the software of the basic unit.....	60
6.11.2	Updating the software of the operating unit	60
6.11.3	Updating the software of the sniffer line.....	61
6.11.4	Updating the software of the I/O module	61
6.12	Switch OFF	62
7	Warning and error messages	63
8	Maintenance.....	71
8.1	Basic unit	71
8.1.1	Replacing the filter plates.....	71
8.1.2	Cleaning the calibration opening.....	72
8.1.3	Replacing the fuses	73
8.1.4	Cleaning the device	73
8.1.5	Change calibration leak (SMART only).....	74
8.2	Sniffer line.....	75
8.2.1	Replacing the filter holder (all sniffer lines).....	76
8.2.2	Replacing the filter block (all sniffer lines).....	76
8.3	Sending for repair or maintenance	76
8.4	Maintenance table	77
9	Decommissioning	78
9.1	Disposing of the device.....	78

9.2 Sending in the device	78
10 Appendix.....	80
10.1 Accessories and spare parts	80
10.2 Menu path	82
10.2.1 Diagnosis	82
10.2.2 Settings	82
10.2.3 Information	83
10.3 CE Declaration of Conformity	84
10.4 RoHS	85
Index.....	86

1 About this manual

This document applies to the software version stated on the title page.

Product names may occur in the document, which are added for identification purposes only and belong to the respective owner of the rights.

1.1 Other associated documents

Interface description, document no. kirb43en1

1.2 Target groups

This instruction manual is intended for the operator of the device and at technically qualified specialists, with experience in the field of leak testing technology.

1.3 Warnings

DANGER

Imminent hazard resulting in death or serious injuries

WARNING

Hazardous situation resulting in potential death or serious injuries

CAUTION

Hazardous situation resulting in minor injuries

NOTICE

Hazardous situation resulting in damage to property or the environment

2 Safety

2.1 Intended use

The device is a leak detector for sniffer leak detection. With the device you locate and quantify leaks on test objects. The HLD6000 sniffs for different gases depending on which sniffer line is connected. The following sniffer lines are available:

- SMART sniffer line for R22, R32, R134a, R404A, R407C, R410A, R1234yf, R1234ze and 3 additional gases from the selectable gases that are verifiable by the device. Also available as sniffer line "SMART PLUS" to reduce sensitivity to solvents such as alcohol.
- Sniffer line for R744 (CO₂)
- Sniffer line for R600a and R290. Also available as sniffer line "R600a/R290 PLUS" to reduce sensitivity to solvents such as alcohol.

A test object always contains gas under overpressure. Check the exterior of the test objects for escaping gas using a sniffer line (sniffing method).

- Operate the device only according to this instruction manual.
- Comply with application limits, see "Technical Data".

Misapplications

Avoid the following, non-intended uses:

- Pumping off aggressive, flammable, explosive, corrosive, microbiological, reactive or toxic substances, creating a hazard
- Aspiration of liquids into the device
- Inspecting electrically live conductors or objects with a sniffer line

Note: This device is not intended to be used in living areas.

2.2 Owner requirements

The following notes are for companies or any person who is responsible for the safety and effective use of the product by the user, employee or third party.

Safety conscious operation

- Operate the device only if it is in perfect technical condition and has no damage.
- Only operate the device in accordance with this instruction manual, in a safety and risk conscious manner.
- Adhere to the following regulations and observe their compliance:
 - Intended use
 - General applicable safety and accident prevention regulations
 - International, national and local standards and guidelines
 - Additional device-related provisions and regulations
- Only use original parts or parts approved by the manufacturer.
- Keep this instruction manual available on site.

Personnel qualifications

- Make sure that authorized personnel have read and understood the operating instructions and all other applicable documents, especially the information on safety, maintenance and repairs, before starting work.
- Only have qualified personnel make the basic settings on the device. The handling of the sniffer line can also be done by laymen according to instructions.

2.3 Duties of the operator

- Read, observe, and follow the information in this manual and in the work instructions provided by the owner. This concerns in particular the safety and warning instructions.
- Always observe the complete operating instructions for all work.
- If you have any questions about operation or maintenance that are not answered in this manual, contact customer service.

2.4 Dangers

The measuring instrument was built according to the state-of-the-art and the recognized safety regulations. Nevertheless, improper use may result in risk to life and limb on the part of the user or third parties, or damage to the unit or other property may occur.

Hazards due to liquids and chemicals	<p>Liquids and chemical substances can damage the instrument.</p> <ul style="list-style-type: none">• Adhere to the restrictions of use.• Do not suck up liquids with the instrument.• Never try to find toxic, caustic, microbiological, explosive, radioactive or other harmful substances with the device.• Only use the device away from areas with a risk of explosions.• Do not expose the device to a naked flame and avoid spark formation, for example, by smoking.
Danger to wearers of pacemakers or implants	<p>The device contains magnets. Pacemakers and other implants can be influenced in their function.</p> <ul style="list-style-type: none">• Keep a distance of at least 10 cm between the device and the implant.
Dangers from electric power	<p>There is a danger to life from the contact of conductive parts inside the device.</p> <ul style="list-style-type: none">• Disconnect the device from the power supply prior to any installation and maintenance work. Make sure that the electric power supply cannot be reconnected without authorization. <p>Contact of the sniffer tip with live parts may result in danger to life.</p> <ul style="list-style-type: none">• Before starting the leak test, disconnect electrically operated test objects from the power supply. Ensure that the electrical supply cannot be switched back on unintentionally. <p>The device contains electric components that can be damaged from high electric voltage.</p> <ul style="list-style-type: none">• Before connecting to the power supply, make sure that the mains voltage on site is within the permitted operating voltage range. The permitted operating voltage range is indicated on the device.
Dangers from strong exposure to light	<p>Exposure of the eyes to LED light can lead to lasting eye damage.</p> <ul style="list-style-type: none">• Do not look into the LEDs of the sniffer handle from a short distance or for longer periods of time.

3 Shipment, Transport, Storage

Scope of delivery	Item	Quantity
	HLD6000 (Basic unit)	1
	Sniffer line (4.8 m) with sniffer tip (100 mm). As sniffer line Standard or as sniffer line PLUS (sniffer line PLUS including certificate)	1
	Mains cable, country-specific	1 or 2
	Fuses	4
	Filter holder for sniffer tip	5
	Filter blocks for sniffer tip	4
	Operating manual	1
	Interface description	1
	USB stick with instructions, software	1

The scope of delivery of the HLD6000 with the order numbers 510-027 and 510-127 also includes a calibration leak.

- ▶ Check the scope of delivery of the product for completeness after receipt.

Transport

NOTICE

Damage caused by transport

Transport in unsuitable packaging material can damage the device.

- ▶ Keep the original packaging.
- ▶ Only transport the device in its original packaging.

Storage

Always store the device in compliance with the technical data, see “Technical specifications [▶ 21]“

NOTICE

Losses due to overly prolonged storage

The service life of a COOL-Check is limited.

- ▶ Do not create inventories.
- ▶ Store the COOL-Check in a cool, dry place.

4 Description

4.1 Function

The HLD6000 is made up of a basic unit and a line with handle. This line is referred to as the sniffer line.

To locate leaks, move the tip of the sniffer line over places from which gas may be escaping. Depending on the design of the sniffer line, you can detect different gases.

In the handle of the sniffer line is an infrared source whose light hits an infrared sensor. If a traceable gas enters the sniffer line with the suctioned air, the light intensity reduces.

Based on the change in light intensity, the HLD6000 measures gases and shows the result optically and acoustically. Measured values are represented on the touchscreen of the basic unit.

Traces of the measured gases are frequently found in the atmosphere. The HLD6000 measures the air in the atmosphere and takes the background concentration of the measured gas and other unwanted gases into account when calculating the measured value.

To be able to find leaks that exceeds a specific gas concentration, set one or two setpoints on the basic unit. If you work with two setpoints, you can toggle between both values whilst measuring by pressing a button.



To reduce the undesired influence of solvents such as alcohol in cleaning agents, glycol, adhesives, packaging materials or exhaust gases on measurement results (cross-sensitivity), you can use a PLUS sniffer line. In a PLUS sniffer line such signals are attenuated by a chemical filter. See also "Accessories and spare parts [▶ 80]". However, these sniffer lines have a lower sensitivity and need more time to become operational.

4.2 Basic unit

The main unit is only called a “device” in the following as long as the meaning remains clear.

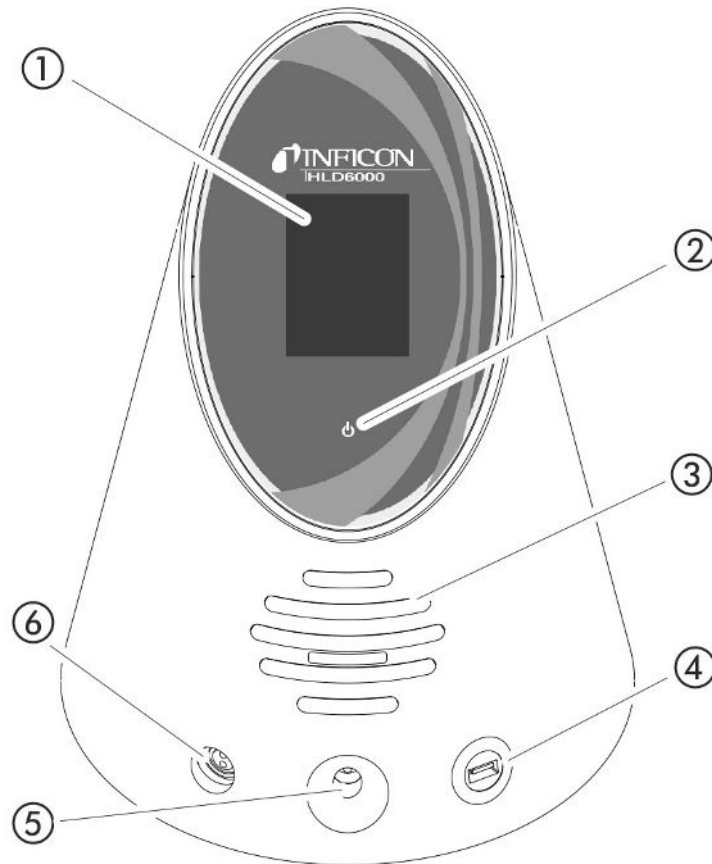

Fig. 1: Front view

1	Touchscreen
2	LED operating display. To display 3 states: <ul style="list-style-type: none"> • green = in operation • flashing green = unit in operation, touchscreen switched off • red = malfunction
3	Speaker
4	USB port: To use a USB stick, see “Using a USB stick [▶ 32]”
5	Calibration opening for internal calibration
6	Sniffer line connection port

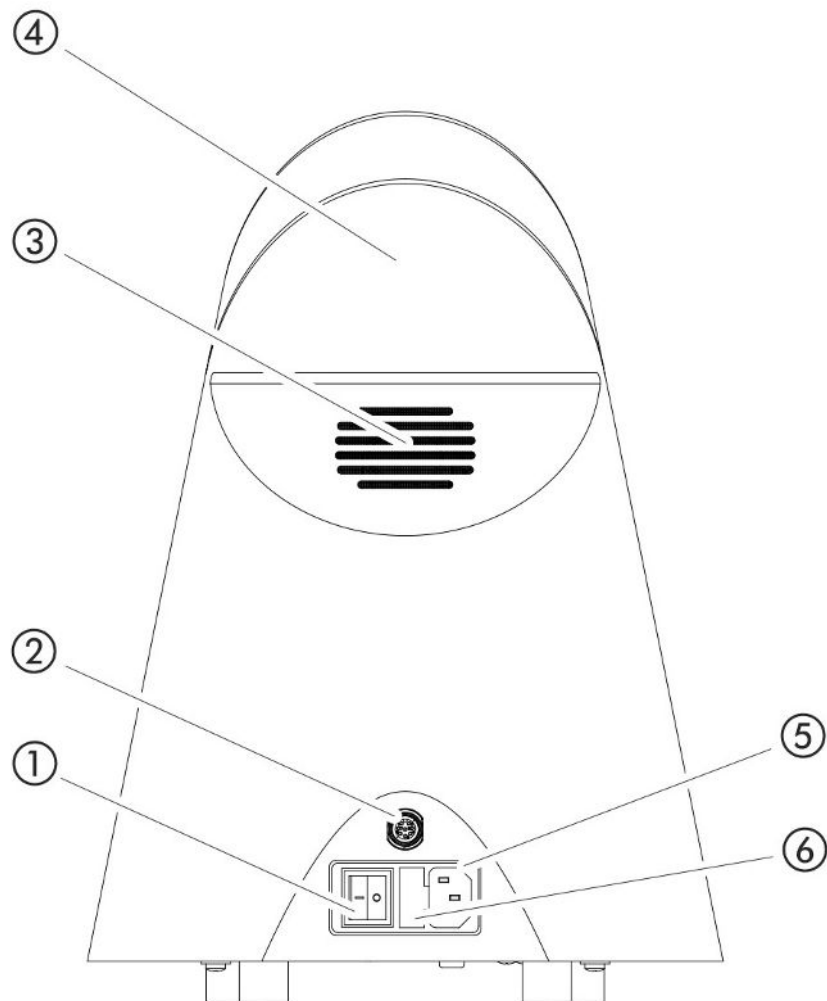

Fig. 2: Back view

1	Mains switch. Turns the device on and off.
2	M12 socket. For connection of the INFICON I/O module, available as accessory, see "I/O module [▶ 38]". Length of the data cable: Max. 30 m
3	Ventilation slots
4	Carry handle
5	Power cable connection
6	Cover for fuse holder. To replace fuses, see "Replacing the fuses [▶ 73]"

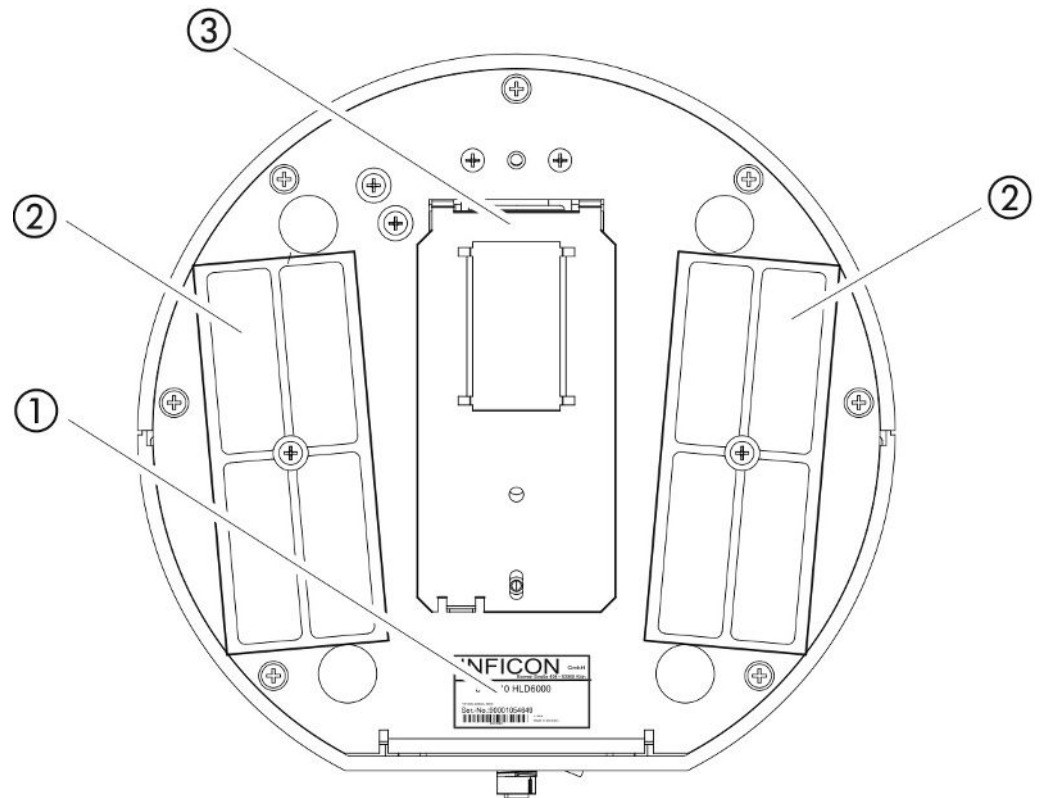





Fig. 3: View from below

1	Nameplate with specifications concerning mains voltage, serial number and production date
2	Filter plates
3	COOL-Check calibration leak behind the cover

4.3 Assembly of the touchscreen

The display primarily works with symbols. Four symbols are always shown on the display: the navigation buttons    . In addition, depending on the context, you will see additional symbols and elements, see below the "Function Keys" table.

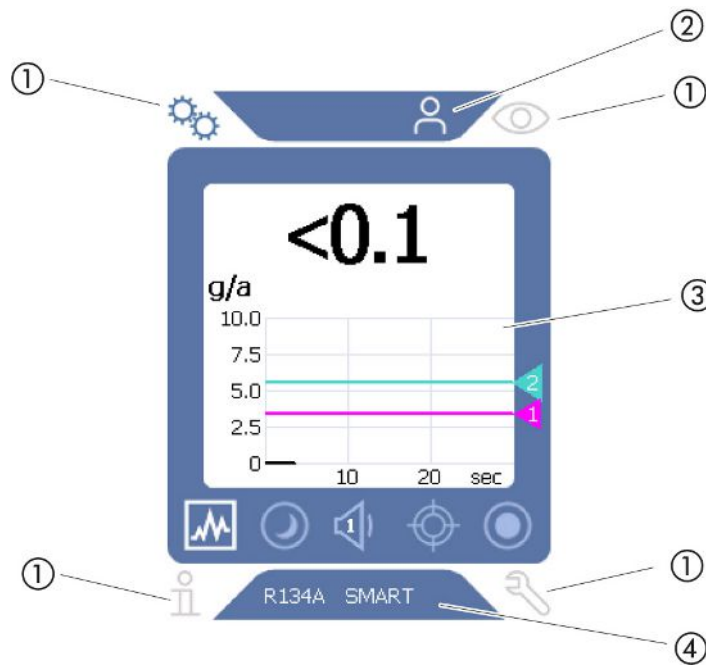

Fig. 4: Start screen after starting up



1	Navigation buttons
2	Menu bar (here: enabled for the operator)
3	Main display area
4	Status bar (in this case, gas and connected handle)

1. Navigation buttons

Four navigation buttons are located in the four corners of the display. Use the navigation buttons to control the various areas and functions of the device.

To get an overview of the setting options, note the display of the menu trees see "Menu path [▶ 82]".

The navigation buttons use different colors to show their status:

The buttons can appear in five different colors:	
	<ul style="list-style-type: none"> • Gray: Function is disabled • Dark blue: Function can be activated • Light blue: Function is active • Red: Error message displayed • Orange: Warning displayed
	<ul style="list-style-type: none"> • Settings symbol • Change settings on the device • Back one settings level
	<ul style="list-style-type: none"> • Symbol for operation • Call up measurement display





	<ul style="list-style-type: none"> • Display active error or warning message
	<ul style="list-style-type: none"> • Information symbol • Display information regarding the unit such as the software version, operating hours, serial number, date and time • Navigate back to the previous information layer
	<ul style="list-style-type: none"> • Diagnostics symbol • Call up diagnostic functions: Service settings, history lists, software update • Navigate back to the previous diagnosis layer • Show active, confirmed warning

Table 1: Navigation buttons

2. Menu bar

The blue menu bar shows you whether you are logged in as a supervisor  or as an operator , see "Access to the settings [▶ 41]".







3. Main display area

The function buttons are located in the blue margin of the main display area. The navigation buttons use different colors to show their status.



The buttons can be displayed in three different colors: gray, light blue, white.

- Gray: Function is disabled
- Light blue: Function can be activated
- White: Function is active

Symbol buttons for measuring and for standby

	Use this button to change the display from a bar graph to a line graph.
	Use this button to change the display from a line graph to a bar graph.
	Change between being in standby or out of standby
	Set the volume for speakers The set volume is displayed on the bottom edge of the display. Value range: 0 (off) to 15 (max.).
	Call up external calibration see "Calibrate with external calibration leak [▶ 50]"
	Starting or stopping the data record see "Measurement data [▶ 53]"

Function symbols during calibration

	Cancel calibration
	Calling up help for calibration



General function symbols	
	Cancel ongoing function
	Call up help for the current function
	Confirm entry or selection

Table 2: Function buttons

The measurement display is also located within the range. For more information see "Measurement display elements [► 18]".

4. Status bar

A text appears in the blue status bar with information about the main display area.

Recalibrating the touchscreen

The HLD6000 is delivered with a calibrated touchscreen. If required, you can recalibrate the touchscreen.

- 1 Switch the instrument off.
- 2 Remove the sniffer line.
- 3 Switch on the device without connected sniffer line.
- 4 If error message 130 is displayed, lead the sniffer tip into the calibration opening at the front of the basic unit within 30 seconds.
 - ⇒ Touch calibration is started.
- 5 Follow the instructions on the touchscreen.
- 6 Switch the device off and reconnect the sniffer line.

4.4 Measurement display elements

The measured leakage rates are displayed numerically and with a linearly subdivided graph. Exceeding the setpoint which is set up is illustrated in color, see "Setting setpoints [► 45]".

The following diagram shows additional elements relating to the measurement display:

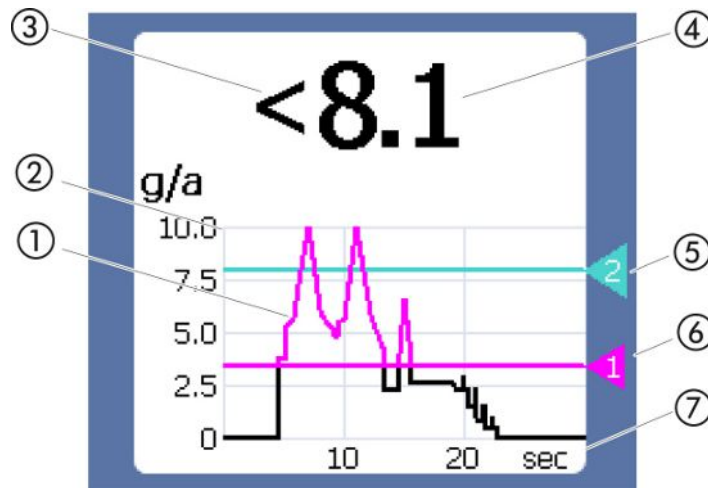

Fig. 5: Measurement display elements

1	History of the measured value (bar or line graph)
2	Value axis
3	If the measured value is lower than that of the lower display limit, the "<" sign is used.
4	Numeric display of the leakage rate
5	Setpoint 2
6	Setpoint 1
7	Time axis



After switching off warning 630 "Calibration request", the message "Calibration required!" is displayed flashing above the measurement display diagram.

This message disappears after recalibration, see "Calibrating [▶ 48]".

4.5 Sniffer line

You need a sniffer line to operate the device. There are sniffer lines for verification of a single gas or sniffer lines for the verification of several gases see "Intended use [▶ 8]". The sniffer line which is delivered as standard is 4.8 m long.

A sniffer line is made of a line, a sniffer probe, and a sniffer tip. The filter holder at the end of the sniffer tip is made of plastic. This reduces the risk of scratching the surfaces to be sniffed.

Sniffer tip

There are rigid and flexible sniffer tips of different lengths, see "Accessories and spare parts [▶ 80]".

Sniffer probe

During measurement it is possible to switch the setpoint using the button on the sniffer probe, provided that this function is activated, see "Setting up the sniffer probe [▶ 46]". The button on the sniffer probe is also used during calibration, see "Calibration with an internal COOL-Check [▶ 49]".

4.5.1 Display on the sniffer line

A status LED is mounted on the handle of the sniffer line, from which you can read off the different operating states, see also table "Signals of the LED on the handle".

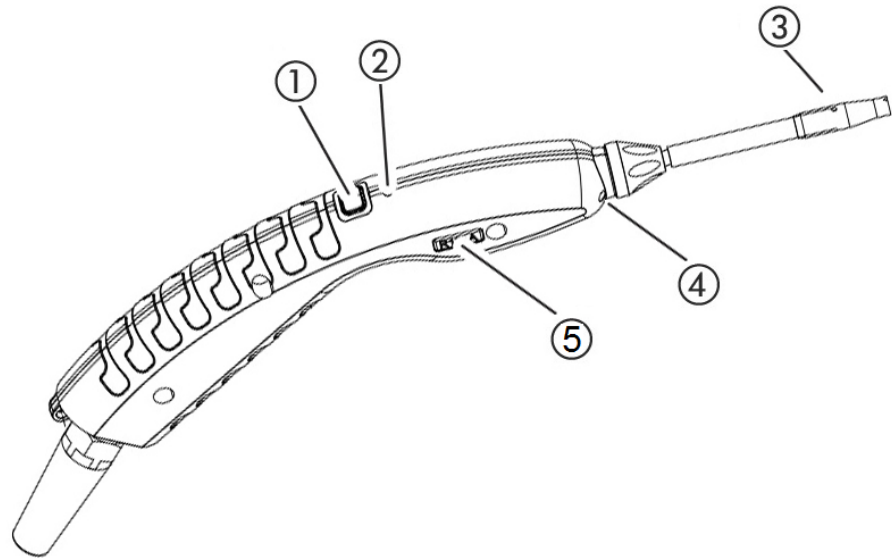

Fig. 6: Sniffer line display

1	Calibration button, see "Time and type of calibration [▶ 48]"
2	Status LED
3	Filter holder on the sniffer tip
4	Illumination LED
5	Name of gas or sniffer line

If the setpoint is exceeded, the color of the status LED switches from green to yellow, see the following table. You can also set the illumination LEDs to flash at the lower end of the sniffer tip, see "Setting up the sniffer probe [▶ 46]".

Signals of the Status LED on the handle grip

Operating status	LED
Not connected	Off
No communication	Blue, flashing
Run-up	Blue
Standby	Blue, flashing
Measuring mode	Green
Leakage rate > 40% of the setpoint	Yellow
Leakage rate > 100% of the setpoint	Yellow, flashing
Calibrating	Blue, flashing
Error/Warning	Red, flashing
Error/Warning and leakage rate > 40% of the setpoint	Red/green, flashing

Operating status	LED
Error/Warning and leakage rate > 100% of the setpoint	Red/yellow, flashing

4.6 Technical specifications

Mechanical data	
Basic unit	
Dimensions (height, diameter)	365 mm; 260 mm (14.4 in.; 10.25 in.)
Weight	4.1 kg
Length of sniffer line	4.8 m
Weight sniffer handle with 3 m cable	790 g

Ambient conditions	
Permissible ambient temperature (during operation)	5 °C to 50 °C
Permissible storage temperature	0 °C to 50 °C
Max. relative humidity up to 31°C	80 %
Max. relative humidity from 31°C to 40°C	Decreasing on linear basis from 80% to 50%
Max. relative humidity above 40°C	50 %
Degree of contamination	II (according to DIN EN 61010-1: Only non-conductive contamination. Occasionally, temporary conductivity may occur due to condensation.)
Max. altitude above sea level	2000 m

Electrical data	
Power supplies and frequencies	100 ... 240V, 50/60 Hz
Power consumption	55 VA
Protection class	EN 60529 IP30 UL 50E Type 1
Overvoltage category	II
Fuses	2 x 1 A slow-blowing (Ø 5 × 20 mm)
Power supply cable	2.5 m
Length of the data cable on the M12 plug	Max. 30 m
Noise level without signal tones	< 54 dBA

Physical data	
Minimum detectable leak rate	
R744 (CO ₂)	1.0 g/a
R600a/R290 standard	1.0 g/a (0.04 oz/yr); for R600a/R290 see "Verifying R290 with the sniffer line for R600a/R290 [▶ 48]"
R600a/R290 PLUS	2.0 g/a
SMART standard	0.5 g/a (0.02 oz/yr); see "Setting up the gas for the SMART sniffer line [▶ 46]"
SMART PLUS	1.0 g/a
Measurement range of sniffer probes	
Individual gases	0 - 100 g/a (10.7 oz/yr)
SMART / SMART PLUS	0 - 300 g/a (10.7 oz/yr)
Time constant of the signal from the leakage rates	< 1 s
Gas flow Measured at 1 atm (1013 mbar) at sea level. The flow rate changes with the geographical height and barometric pressure.	320 sccm (typical for a standard sniffer line), 250 sccm (typical for a PLUS sniffer line)
Attenuation factor for interfering gas signal of isopropanol when using a PLUS sniffer line. Attenuation factors depend on the specific solvent.	500 (typical)
Time to readiness for measurement of a HLD6000 with a standard sniffer line	< 30 s
Time to readiness for measurement of a HLD6000 with a PLUS sniffer line	30 minutes (typical)
Response time	< 1 s

4.7 Factory settings

(For current device settings see "Parameter list [▶ 57]"

General factory settings	
Analog output upper limit	100 g/a
Display off after	1 h
Display brightness	100 %
Diagram maximum value (log.)	+3
Diagram maximum value (lin.)	20.0 g/a
Display upper limit (lin.)	300.0 g/a
Display upper limit (log.)	+3
Display unit leakage rate	g/a
Autoscale	on
Bus module address	126
Data recording	Off
Diagram of the leakage rate	Line chart
Factor user gas 1	0.0
Factor user gas 2	0.0
Factor user gas 3	0.0
Error information operator	No. and text
Error information supervisor	No., text and info
Filter change request	On
Filter change interval	40 hours
Gas of R600a sniffer line	R600a
Gas in the SMART sniffer line	R134a
Gas of R600a sniffer line	R600a
I/O module log	ASCII
Auto standby interval	2 min.
Interval for calibration request	60 min.
Calibration factor	15.0 (Calibration factor when first commissioning a standard device). The calibration factor cannot be reset to factory settings. It can be changed by the service team.)
Config. Analog output 1	Leakage rate linear
Config. Analog output 2	Leakage rate linear
Configuration PLC Output 1	Setpoint 1 (inverse)

General factory settings	
Configuration PLC Output 2	Setpoint 2 (inverse)
Configuration PLC Output 3	Open
Configuration PLC Output 4	Open
Configuration PLC Output 5	Measure
Configuration PLC Output 6	Error (inverse)
Configuration PLC Output 7	CAL request (inverse)
Configuration PLC Output 8	Open (inverse)
Configuration PLC Input 1	No function
Configuration PLC Input 2	No function
Configuration PLC Input 3	Start/Stop (inverse)
Configuration PLC Input 4	No function
Configuration PLC Input 5	CAL external
Configuration PLC Input 6	No function
Configuration PLC Input 7	Delete
Configuration PLC Input 8	No function
Configuration PLC Input 9	No function
Configuration PLC Input 10	No function
Volume	5
Leakage rate setpoint 1	5.0 g/a
Leakage rate setpoint 2	10.0 g/a
Show measured value	On
Module at M12 connector	I/O
Name user gas 1	User 1
Name user gas 2	User 2
Name user gas 3	User 3
Phase	20 (Phase during initial setup. The phase cannot be reset to factory settings. It can be changed by the service team.)
External calibration leak	10 g/a
Interface unit leakage rate	g/a
Sniffer light alarm configuration	Flashing
Sniffer light	brightness 4
Probe key configuration	Setpoint
Setpoint audio alarm	Setpoint
Screenshot with probe key	Off
Record interval	500 ms

General factory settings	
Memory location	USB
Language	English
Show warnings	On
Value axis decades	3
Value axis grid	Linear
Time axis scale	30 s

Factory settings for access authorization	
Analog output upper limit	Supervisor
Display off after	Operator
Display brightness	Operator
Diagram maximum value (log.)	Operator
Diagram maximum value (lin.)	Operator
Display upper limit (lin.)	Operator
Display upper limit (log.)	Operator
Display unit leakage rate	Operator
Autoscale	Operator
Bus module address	Supervisor
Data recording	Operator
Date and time	Supervisor
Diagram of the leakage rate	Operator
Factor user gas	Supervisor
Error information operator	Supervisor
Error information supervisor	Supervisor
Filter change request	Supervisor
Filter change interval	Supervisor
Gas of R600a sniffer line	Supervisor
Gas in the SMART sniffer line	Operator
I/O module log	Supervisor
Auto standby interval	Supervisor
Calibration request interval	Supervisor
Calibration factor	SERVICE
Config. Analog output	Supervisor
Configuration PLC Output	Supervisor
Configuration PLC Input	Supervisor

Factory settings for access authorization	
Volume	Operator
Leakage rate setpoint	Supervisor
Show measured value	Operator
Module at M12 connector	Supervisor
Name user gas	Supervisor
Phase	SERVICE
External calibration leak	Supervisor
Interface unit leakage rate	Supervisor
Sniffer light alarm configuration	Supervisor
Sniffer light brightness	Supervisor
Probe key configuration	Supervisor
Setpoint audio alarm	Supervisor
Screenshot with probe key	Supervisor
Record interval	Operator
Memory location	Operator
Language	Operator
Show warnings	SERVICE
Value axis decades	Operator
Value axis grid	Operator
Time axis scale	Operator

5 Installation

5.1 Setup



⚠ DANGER

Danger to wearers of pacemakers or implants

The device contains magnets. Pacemakers and other implants can be influenced in their function.

- ▶ Keep a distance of at least 10 cm between the device and the implant.

⚠ WARNING

Danger from moisture and electricity

Moisture entering the device can lead to personal injury due to electric shocks as well as damage to property due to short circuiting.

- ▶ Only operate the device in a dry environment.
- ▶ Operate the device away from sources of liquid and moisture.

NOTICE

Property damage due to overheated device

The device heats up during operation and can overheat without sufficient ventilation.

- ▶ Please note the technical data, see “Technical specifications [▶ 21]“.
- ▶ Ensure sufficient ventilation, especially on the ventilation slots on the left and right of the device: At least 20 cm of free space on the sides, at least 10 cm in the front and rear.
- ▶ Keep heat sources away from the device.
- ▶ Do not expose the device to direct sunlight.

5.2 Sniffer line

5.2.1 Connecting the sniffer line

Connect the sniffer line before you start up the device.

If the sniffer line is not connected then the device reports an error.

If you remove the sniffer line during operation, the device also reports an error.

- 1 Align the red marking on the sniffer line plug with the red marking on the socket of the device (see “Basic unit [▶ 13]”, Fig. 1).
- 2 Push the sniffer line plug into the socket on the device until it locks into place.
⇒ The plug may no longer be easy to move.

5.2.2 Exchanging the sniffer line

- 1 Select the sniffer line of the gas you wish to detect.
 - 2 Switch the instrument off.
 - 3 To release the plug on the sniffer line from the socket of the device, pull the grooved ring on the plug until the lock is opened.
 - 4 Pull off the sniffer line.
 - 5 Attach the new sniffer line.
- ⇒ You can switch the device back on again.



HLD6000 with one PLUS sniffer line

To operate a PLUS sniffer line, a basic unit software version of V2.11 or later is required.

The device automatically adjusts to the connected sniffer line (Standard or PLUS).

5.3 Sniffer tip

5.3.1 Replacing the sniffer tip

NOTICE

Material damage from pollution

Particles in the air intake can destroy the sniffer line.

- ▶ Always switch off the device before every installation!
- ▶ Make sure that no particles enter into the air intake when replacing sniffer tip parts.

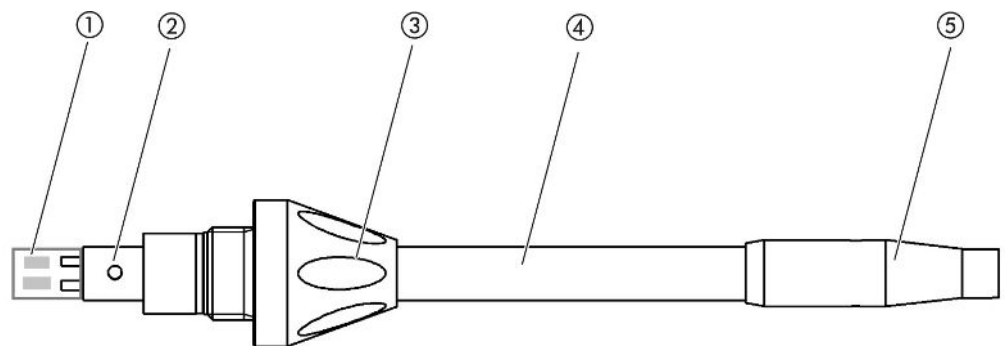

Fig. 7: Sniffer tip

1	Filter block
2	Guide pin
3	Cap nut
4	Sniffer tip
5	Filter holder

- 1 Switch the instrument off.
 - 2 Loosen the cap nut until the sniffer tip can be pulled out.
 - 3 Insert the new sniffer tip into the sniffer probe in such a way that the guide pin runs into the groove of the sniffer probe opening.
 - 4 Tighten the cap nut.
 - 5 Calibrate the device see "Time and type of calibration [▶ 48]".
- ⇒ Further sniffer tips see "Accessories and spare parts [▶ 80]".
- ⇒ To replace the filter see "Sniffer line [▶ 75]".

5.3.2 Using a water conservation sniffer tip

If there is a risk of sucking in liquids then a water conservation tip should be used, see "Accessories and spare parts [▶ 80]".

You can use the water conservation sniffer tip to check test objects with low surface moisture, e.g. condensation moisture, for leaks.

- ▶ Screw the water conservation sniffer tip to the end of the filter holder.



Fig. 8: Water protection sniffer tip installed

NOTICE

Risk of short circuit

Sucked in liquid can destroy the device.

- ▶ Do not suck up liquids with the instrument.

- ▶ Do not hold the sniffer line with the sensor pointing up since moisture will flow into the sensor as a result. If liquid has been spilled in the direction of the sensor, hold the sniffer line with the tip pointing down and run the device for about 10 minutes.



With the water conservation sniffer tip installed, you cannot calibrate with the internal COOL-Check.

5.3.3 Using flexible sniffer tip

If you are examining test objects which have already been packed or test objects with areas that are difficult to access then an extended sniffer tip can be used, see "Accessories and spare parts [▶ 80]".

In addition to the rigid sniffer tip what comes delivered with the HLD6000 you can also use a 400 mm long flexible tip. By bending the flexible tip accordingly, hard-to-reach areas can also be accessed.

5.3.4 Using an extension hose for a sniffer tip

To get into hard-to-reach areas, attach an extension hose to the sniffer tip, see "Accessories and spare parts [▶ 80]".



Note that you cannot trace CO₂ with an extension hose!

With the extension hose installed, you cannot calibrate with an external CO₂ calibration leak.

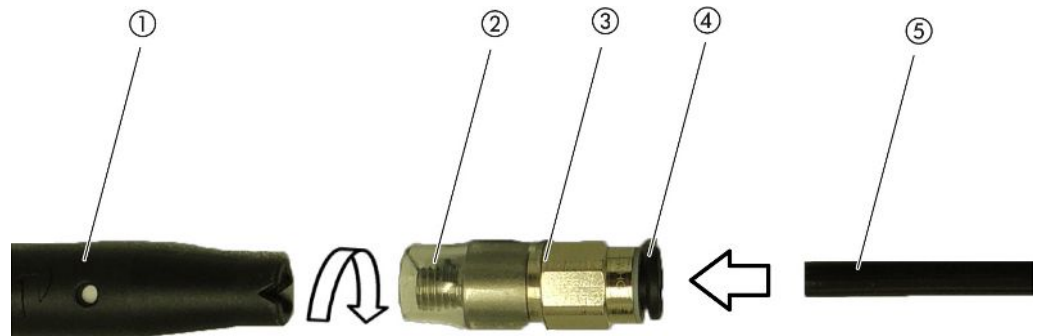

Fig. 9: Attach the extension hose

1	Filter holder on the sniffer tip
2	Short extension hose
3	Adapter
4	Release ring
5	Extension hose

If it is necessary to shorten the extension hose, cut off the end of the extension hose that you use to sniff the test object at an angle of about 45°.

- 1 To attach the extension hose to the sniffer tip, screw the adapter from the set with the extension hose to the filter holder at the end of the sniffer tip.
 - ⇒ Make sure that the short extension hose at the end of the adapter encloses the filter holder.
- 2 Insert the extension hose into the rear opening of the adapter.
 - ⇒ The extension hose is automatically locked into position.
- 3 To connect the extension hose to the calibration opening for internal calibration for the COOL-Check, insert the centering ring into the calibration opening on the device to make the COOL-Check opening smaller.



Fig. 10: Insert centering ring

Disassembly

- ▶ To remove the extension hose press the release ring in the direction of the adapter so that the locking device releases and thus enables the extension hose to be removed.

5.4 Using calibration leaks

A built-in calibration leak (COOL-Check) and various external calibration leak devices are available as accessories for the device, see "Accessories and spare parts [▶ 80]".

No COOL-Check is available for the R744 (CO₂) and R600a/R290 gases. Solely calibrate the sniffer line for the R744 and R600a/R290 gas using external calibration leaks.

To change the COOL-Check, see "Change calibration leak (SMART only) [▶ 74]".

5.5 Connecting to the power supply system

WARNING

Danger from electric shock

Improperly grounded or fused products may be dangerous to life in case of a fault. The use of the device is not permitted without a connected protective ground conductor.

- ▶ Only use the included 3-wire power cable.

5.6 Using a USB stick

With a USB stick, you can

- Record measured data, see "Measurement data recording [▶ 53]",
- Save settings, see "Save parameters [▶ 43]",
- Save histories, see "Diagnosis [▶ 55]",

- Store measured data, see "Transferring measured data from the internal memory to a USB stick [► 55]".

The USB stick must be formatted in the FAT file system.

5.7 Connecting a PC

Connection is done using the I/O module, see "Accessories and spare parts [► 80]".

Please refer to the "Interface Protocols" (doc. no. kirb43en1) for further information on data exchange.

6 Operation

6.1 Switch ON

Connect a sniffer line and switch on the device.

The device will start up and, after a short time, display "Reading data".



Fig. 11: The device starts up

- ▶ In order to switch to English from another language, press "EN" on the depicted window.

After the run-up, the device will measure the leakage rate on the sniffer line. There is no separate Start function.



HLD6000 with one PLUS sniffer line

The device must typically be in operation for at least 30 minutes to achieve all measuring and filtering characteristics. The measurement sensitivity may change within the first 30 minutes.

- ▶ Do not calibrate or measure until 30 minutes after switching on the device.

- 1 Make basic settings, see "Basic settings [▶ 35]".
- 2 Make adjustments to settings for the measuring process and calibrate the device, see "Settings for the measurements [▶ 45]".

If the COOL-Check calibration leak is not located in the device, an acoustic warning signal sounds and the 163 warning message is issued during the initial start-up.

If calibration is required, the warning 630 "Calibration request" is issued, see "Measurement display elements [▶ 18]".

- ▶ To close this warning message, press the ⊗ button.

6.2 Basic settings

- To get an overview of the setting options, note the display of the menu trees see "Menu path [▶ 82]".
- You can either carry out your own changes or keep the factory settings, see "Technical specifications [▶ 21]".
- Your settings can be saved at any time to restore to an earlier state if required, see "Save parameters [▶ 43]".

6.2.1 Setting the language

You can choose from the following languages for the touchscreen display:

- English (factory setting)
 - German
 - French
 - Italian
 - Spanish
 - Portuguese
 - Chinese
 - Japanese
- ▶  > Setup > Language

In order to switch to English from another language directly after switching on the device, press "EN" on the device's touch screen during run-up.

6.2.2 Setting date and time

Date and time are stored in the following formats:

- Date in the DD.MM.YY format
 - Time in the HH:MM format
- ▶  > Setup > General > Date and Time

6.2.3 Adjust volume

WARNING

Hearing damage from excessively loud signal tones

The volume of the signal tones can exceed 85 dB(A).

- ▶ Keep away from the device when setting high volumes.
- ▶ Wear ear protection when necessary.

▶ > Volume

⇒ Volume

You can adjust a volume. The setting applies to the speaker in the basic unit.
Setting range: 0 to 15

⇒ Test

A tone at the set volume is issued.

- ⇒ Alternatively, when on the touchscreen select the button .

6.2.4 Setting auto standby

As well as having the option to manually switch over into standby mode (see “Standby [▶ 55]”), it is also possible to set up an auto standby function. This setting defines the period of time after that the device automatically enters standby mode when not in use.



HLD6000 with one PLUS sniffer line

This feature is not available for PLUS sniffer handles. For these handles the setting is ignored and the device does not automatically switch to standby mode. However, it is still possible to manually switch to standby mode. Please note that a PLUS sniffer probe requires a minimum 30 minute warm-up time after standby and requires recalibration.

▶ > Setup > Auto Standby

⇒ Standby off

To turn off the automatic standby function

⇒ Set the time between one and 15 minutes.

To turn on the automatic standby function

6.2.5 Setting the display



If necessary, change the type of display.

▶ > Display Settings

- ⇒ "Value display"
For displaying the measurements as a bar or line graph
For switching the measurement display on or off
- ⇒ "Value axis"
"Value axis grid": For switching between a linear and logarithmic view
"Value axis decades": If the logarithmic view is selected for "value axis grid" then you can choose whether 1, 2, 3, or 4 decades are displayed.
- ⇒ "Scaling value axis"
"Auto scale": For switching auto scale on or off
- ⇒ "Display maximum value (log.) exponent": If the auto scale is switched off and the logarithmic view is selected then you can set the exponent of the upper display value.
"Display maximum value (lin.)": If the auto scale is switched off and the linear view is selected then you can set the upper display value.
- ⇒ "Time axis"
For changing the time axis between 15 s, 30 s, 60 s, 120 s, 240 s, 480 s, 960 s
- ⇒ "Units" (for displaying the leakage rate)
g/a (factory setting)
lb/yr
mbar l/s
oz/yr
Pa m³/s
- ⇒ "Brightness"
"Display brightness": For selecting brightness, choose between 20, 30, 40, 50, 60, 70, 80, 90, or 100%
"Display off after": Choosing whether the display is switched off after 30 s, 1 min., 2 min., 5 min., 10 min., 30 min., or 1 h.
The time runs after a key on the touchscreen has been pressed for the last time or a status change has taken place (exceeding the setpoint, appearance of a warning, etc.).
- ⇒ "Display limits"
"Display upper limit (log.) exponent": The displayed value is limited to this value.
The values 0, 1, 2 or 3 are possible.
"Display upper limit (lin.)": This is for establishing an upper limit (lin.), for example between 5, 10, 20, 50, 100, 200 or 300 g/a.



6.2.6 Set time interval for calibration request

You can switch off the time-controlled calibration request or set intervals between 30 minutes and 24 hours, after which a calibration request is displayed.

- 1  > Setup > Request
- 2 Select "off" or input a time interval.
- 3 Confirm with .

6.2.7 Setting the filter change request



See also "Replacing the filter holder (all sniffer lines) [▶ 76]".

- 1  > Setup > Request
- 2 Choose "on" or "off".
- 3 If you have chosen the setting "On", you can set the timespan between two requests.
- 4 Confirm with .

6.2.8 I/O module



Introduction information: Instruction manual IO1000 I/O module, document no. jiqc10

6.2.8.1 Create a connection between the device and the I/O module

- 1 Switch the instrument off.
- 2 Connect the INFICON I/O module with a data cable to the M12 socket on the rear of the device, see "Basic unit [▶ 13]", Fig. 2.
- 3 Switch on the HLD6000.
- 4  > Setup > Interfaces > Device selection
- 5 Select "I/O".
- 6 Confirm with .



6.2.8.2 Configuring analog outputs

You can determine how the voltage of the analog outputs is set.

- 1  > Setup > Interfaces > I/O module > Analog outputs
- 2 For "Config. analog output 1" or "Config. analog output 2" choose between:
 - Set by interface
 - Leakage rate linear
 - Off
- 3 Confirm with .



6.2.8.3 Setting the upper scale value for 10 V of the analog output

You can set which leakage rates are represented by 10 V on the analog output. This setting only comes into effect when "leakage rate linear" is selected for the configuration of the analog output.



- 1  > Setup > Interfaces > I/O module > Analog scale
- 2 To set the upper scale value, enter a numerical value between, for example, 10 g/a and 1000 g/a using the buttons.
- 3 Confirm with .

6.2.8.4 Setting up the I/O module protocol

If necessary, set the format of the I/O module protocol.



- 1  > Setup > Interfaces > I/O module > Protocol
⇒ See also "Interface description HLD6000 (doc. no. kirb43en1)".
- 2 Select between "ASCII", "LD", "Normal", and "Simple".
- 3 Confirm with .

6.2.8.5 Configuring digital outputs



- 1  > Setup > Interfaces > I/O module > PLC outputs
- 2 Select one of the 8 PLC outputs and allocate a function to it:
 - Setpoint 1 or 2
 - CAL internal active
 - CAL external active
 - PROOF active
 - Warning
 - Error
 - CAL or PROOF active
 - CAL request
 - Run up
 - Sniffer button
 - Light barrier
 - Measuring
 - Standby
 - Sniffer is closed
 - Error or warning
 - CAL internal possible
- 3 Choose between "Normal" or "Inverse".
- 4 Assign additional PLC outputs to a function if necessary.
- 5 Confirm with .

6.2.8.6 Configure digital inputs

You can set which function is carried out by a signal on the digital input.

- 1  > Setup > Interfaces > I/O module > PLC inputs
- 2 Select one of the 10 PLC inputs and allocate a function to it:
 - No function
 - CAL extern
 - Start
 - Stop
 - Delete
 - Trigger selection (to use this function, switch the "Sniffer button configuration" to "Off", see "Setting up the sniffer probe [▶ 46]").
- 3 Choose between "Normal" or "Inverse".
- 4 Assign additional PLC inputs to a function if necessary.
- 5 Confirm with .

6.2.8.7 Setting the interface unit

- 1  > Setup > Interfaces > I/O module > Units
- 2 Select the unit for the output of leakage rates from the following options:
 - g/a (factory setting)
 - lb/yr
 - mbar l/s
 - oz/yr
 - Pa m³/s
- 3 Confirm with .

6.2.9 Bus module



On the USB stick that comes with the HLD6000 and the BM1000 bus module, you will find further bus module files. This also includes the GSD file for PROFIBUS, which is located in the "..\Manuals\Interface Description" folder.

For the different bus modules from INFICON see also "Accessories and spare parts [▶ 80]".

6.2.9.1 Creating a connection between the device and the bus module

To create the connection between the bus module and the device, do the following:



- 1 Switch the instrument off.
- 2 Connect the INFICON Bus module with a data cable to the M12 socket on the rear of the device, see "Basic unit [▶ 13]", Fig. 2.
- 3 Switch on the HLD6000.

- 4  > Setup > Interfaces > Device selection
- 5 Select "Bus" as the module at M12 connector.
- 6 Confirm with .

6.2.9.2 Setting a bus module address

You can set the setpoint for the field bus address. With PROFIBUS® this is the node address. DeviceNet is the MAC ID.



This setting is irrelevant for Profinet and EtherNet/IP.

- 1  > Setup > Interfaces > Bus module > Adress
- 2 Use the keyboard shown for your entries.
- 3 Confirm with .

⇒ The value set is first carried over when restarting the HLD6000. To do this, switch the power supply off and back on.

6.2.10 Setup scope of error messages

You can set up the scope within which error messages are shown on the display during operation of the device. This can be set up separately for the supervisor and the operator.



- 1  > Setup > Advanced setup > Error information
- 2 Under "Error information operator" or "Error information supervisor" choose between
 - No.
 - No. and text
 - No. , text and info
- 3 Confirm with .

6.2.11 Access to the settings

Role concept

- If you are logged in as a "supervisor" then you can change all settings available in the device, protect against changes and check test objects for leaks.
- If you are logged in as an "operator" then you can change settings as far as is authorized and check test objects for leaks. The scope of the adjustment options depends, on the one hand, on the factory settings and on the other hand whether the "supervisor" has assigned or withdrawn permissions. When individual parameters are grayed out then no changes can be made.
- For a list of the preset parameter access controls, see "Factory settings [▶ 23]".

The active role can be seen on the menu bar on the touchscreen:

As "operator" you see the symbol , as "supervisor" you see the symbol .

Starting procedure in delivery condition

A stored PIN number is assessed during the starting procedure.

The PIN "0000" is preset in delivery condition. This means the device is started with a log-in as "supervisor".

Starting procedure after assigning the PIN

The "supervisor" can protect existing settings by inputting a PIN number. After restarting the device it restarts with a log-in as "operator". This can be switched over to "supervisor" only when the correct PIN is entered.

6.2.11.1 Protecting settings via PIN assign

✓ You are logged in as a "supervisor" .

1  > Access Ctrl. > Supervisor > PIN Assign

2 Enter a 4-digit number of your choice as the PIN.

⇒ So that your settings are protected, do not select "0000", see "Access to the settings [▶ 41]", section "Starting procedure in delivery condition".

To cancel protection again, enter "0000" as the PIN (factory setting).

If you have forgotten the supervisor PIN, then please contact the INFICON service team.

Further information can be found from the help text when entering the PIN.

6.2.11.2 Switch from supervisor to operator

✓ You are logged in as a "supervisor" .

▶  > Access Ctrl. > Operator

If you have stored a PIN for an operator, alternatively switch the device off and on again.

6.2.11.3 Switch from operator to supervisor



1  > Access Ctrl. > Supervisor

2 Enter the PIN which is stored for logging in as "supervisor".

6.2.11.4 Changing parameter access controls





✓ You are logged in as a "supervisor" .

1  > Parameter > Parameter access level

- ⇒ A list of all parameters is shown including the assignments to "supervisor" and "operator".
- 2** To change a parameter assignment in the list illustrated, press on an entry when logged in as "supervisor".
 - ⇒ Pressing on an entry changes the shown assignment between "supervisor" and "operator".
- 3** To reject the change, press on  or to confirm, press on .
- ⇒ With regards to the factory settings see "Factory settings [▶ 23]"

6.2.12 Save parameters





Regardless of access rights, you can select parameters and save them on a USB stick.

- ✓ You are logged in as a "supervisor"  or as an "operator" .
 - 1** Connect a USB stick with the USB port on the device.
 - 2**  > Parameter > Save
 - 3** Either select all parameters or just individual parameters.
 - 4** Confirm with .
- ⇒ If necessary, the saved parameters can be transferred back to the device, see "Load parameters [▶ 43]".

6.2.13 Load parameters

As "supervisor"  you can transfer all parameters belonging to the selected parameter file from the USB stick onto the device.

If you are logged in as an "operator"  then only those parameters which you are authorized to access are transferred from the selected parameter file to the device.

- ✓ You are logged in as a "supervisor"  or as an "operator" .
 - 1** Connect a USB stick with the USB port on the device.
 - 2**  > Parameter > Load
 - 3** Select a parameter file.
 - 4** Confirm with .

6.2.14 Switching the "Screenshot" function on or off

To allow screenshots to be saved on a USB stick, enable the "Screenshot" function. You can use screenshots when contacting INFICON service.

- 1** Insert a FAT formatted USB stick with the USB port on the device.
- 2**  > Display settings > Screenshot

3 Under "Screenshot with probe key" choose between "On" or "Off".

4 Confirm with .

For further information on saving screenshots see "Measuring [▶ 52]".

6.3 Settings for the measurements

6.3.1 Setting setpoints

By setting setpoints you can define which quantity of escaping gas you want maximum tolerance for a test object.

One setpoint

You only set setpoint 1. For the values, see also the following table.

The button on the sniffer probe is not required to switch from one setpoint to another setpoint.

1  > Setpoints > Leakage Rate Setpoint 1

2 Adjust.

or

Two setpoints

Alternatively you can set setpoint 1 and setpoint 2 and when measuring toggle between both setpoints by pressing the button on the sniffer line.

You can only use setpoint 2 when the function for the sniffer line button is set to "Setpoint" in the settings, see "Setting up the sniffer probe [▶ 46]".

1  > Setpoints > Leakage Rate Setpoint 2

2 Adjust.

Example of two setpoints:

To identify leaks, measure a test object sensitivity with low setpoint without pressing the button on the sniffer line.

If the device reports a leak, press the button on the sniffer line to measure the test object with the higher setpoint 2.

Setting ranges

Unit	Lower setpoint	Lower setpoint SMART Sniffer line	Upper setpoint
g/a	1.0	0.5	99.0
mbar l/s ⁻¹	4 x 10 ⁻⁶	4 x 10 ⁻⁶	3.9 x 10 ⁻⁴
lb/yr	2 x 10 ⁻³	1	1x 10 ⁻¹
oz/yr	0.04	0.02	1.76
Pa m ³ x s ⁻¹	4 x 10 ⁻⁷	4 x 10 ⁻⁷	3.9 x 10 ⁻⁵

Table 3: Setting range for setpoints

6.3.2 Setting up an alarm profile for setpoints

You can set up how you are acoustically made aware of measurement results during measurements.

▶  > Setpoints > Setpoint alarm

Requirements	Alarm profile Pinpoint	Alarm profile Setpoint	Alarm profile Trigger
	Recommended, for precise leak localization. The sound of the acoustic signal changes its frequency within a window around the setpoint.	The pitch level is proportional to the leakage rate.	If the selected setpoint is exceeded, then a two-pitch signal is issued.
Setpoint undercut	-	No sound	No sound
Setpoint exceeded	-	Signal tone with increasing frequency	Two-tone signal
Acoustic tracing of the measurement result	< 1/10 Setpoint: Low frequency	-	-
	>1/10 setpoint up to 10 × setpoint: Rising frequency		
	> 10 × setpoint: High frequency		

6.3.3 Setting up the sniffer probe

▶  > Set Up > Sniffer line

Key configuration

You can change between both setpoints via the button on the sniffer probe.

This function can be switched either on or off: "Setpoint" or "Off".

Regarding setpoints see "Setting setpoints [▶ 45]".

To replace the setpoints see "Measuring [▶ 52]".

Light brightness

You can adjust the general brightness of the light of the sniffer probe in several steps.

Light Alarm function

Light when exceeding the setpoint. There are 3 options regarding the settings:

Off, Brighter, Flashing.

6.3.4 Setting up the gas for the SMART sniffer line

If you use a SMART sniffer line then several different gases can be sniffed. R22, R32, R134a, R404A, R407C, R410A, R1234yf and R1234ze gases are preset. In addition you can also choose 3 further gases from a list of gases that the device can verify.

Preset gases**Select preset gas**

- 1  > Gas
- 2 Set the desired gas.
 - ⇒ If you have internally calibrated a preset gas and are switching over to another preset gas then recalibration is not required.
 - ⇒ If you have externally calibrated a preset gas and are switching over to another preset gas then the device prompts you to calibrate.

User-defined gases**Enter name for user defined gas**

You can enter a maximum of 3 additional gases of your choice, provided that these can be verified by the device. You can obtain more information about this from INFICON by request.

- 1  > Setup > Advanced setup > SMART user gases
 - 2 Enter the desired name under <Name user gas 1> or <Name user gas 2> or <Name User gas 3>.
- ⇒ You can set the values for the user defined gas.

Set values for the user defined gas**Option 1: Calibrate the device with the desired gas using an external calibration leak.**

- 1  > Gas
- 2 Set the desired user-defined gas.
 - ⇒ The calibration factor should be set to "0" in the settings window under "Factor user gas".
- 3 Then calibration with the external calibration leak can be carried out, see "Calibrate with external calibration leak [▶ 50]".

Option 2: Calibrate the device with the desired gas without an external calibration leak.

- ✓ You have an internal COOL-Check as the basis for calibration with the refrigerant R134a.
 - ✓ You know the calibration factor for automatic deviation correction. For most gases the required calibration factors from INFICON can be used.
- 1  > Gas
 - 2 Set the desired user-defined gas.
 - 3 In the setting window under "Factor user gas" enter the calibration factor which you received from INFICON.
 - ⇒ When carrying out the unit calculation of user gases in mbar l/s and Pa m³/s an average molecular weight of 96 is assumed. If this is not accurate enough then calibrate externally using a test leakage value in the corresponding unit.

- 4 Then calibration with the internal COOL-Check can be carried out, see “Calibration with an internal COOL-Check [▶ 49]”.

6.3.5 Verifying R290 with the sniffer line for R600a/R290

It is also possible to verify R290 (propane) with a sniffer line for R600a.

Switching on the note on the R290 measurement

▶  > Gas

Activate the option to display an additional information text in the status line of the measurement screen for the R290 measurement.

Selection	Display in status line
R600a	R600a
R290	R290 @ R600a

Further preparations

Also note the following:

The measuring sensitivity for R290 is approx. 7% higher than for R600a.

You have the option of

- calibrating with an external calibration leak with R290 to avoid overly high displays or
- calibrating with an external calibration leak with R600a.

If sniffing with the R290 then the displayed measurement results will be 7% too high.

It is therefore recommended to also set the setpoint 7% higher than for sniffing with the R600a.



If the calibration has been carried out in g/a, for example, after switching to the units mbar l/s or Pa m³/s, the measured values are inaccurate. When converting units from R600a to R290, an average molecular weight of 51 g/mol is assumed for both gases.

- ▶ For the greatest possible accuracy, you should therefore calibrate directly in the desired unit. Details of leakage rates in various units can be found in the acceptance test certificate for the calibrated leak.

6.3.6 Calibrating

6.3.6.1 Time and type of calibration

The device should be calibrated daily and after every operator change.



HLD6000 with one PLUS sniffer line

An HLD6000 to which a PLUS sniffer line is connected must typically be in operation for at least 30 minutes. Only then are all filter and measuring characteristics achieved.

Calibration is also required after the following actions:

- Changing the sniffer line (at least 20 minutes waiting time after connecting a PLUS sniffer line)
- Switching the sniffer probe
- Switching between the gases
- Request for calibration by the system

If you insert a COOL-Check calibration leak then this is the easiest method to calibrate the device.

Insert the COOL-Check into the base plate of the device, see "Change calibration leak (SMART only) [▶ 74]".

The leakage rate of the COOL-Check is temperature compensated and thus makes the accuracy required for calibration possible. The COOL-Check calibration leak contains R134a.

The most accurate calibration is achieved with the external calibration leak. The calibration leaks apply to one gas each and are temperature resistant.

When using a sniffer line for R744 (CO₂) or a sniffer line for R600a/R290 then calibration can only take place with one external calibration leak.

The gas that leaks from the calibration leak is carried away by strong air currents.

Keep this in mind when, for example, a fan blower is standing in your surroundings. Strong air currents provide false results when calibrating.

If you have assembled an extension hose for the sniffer tip then before calibrating with the internal COOL-Check insert a centering ring to make the calibration opening on the device smaller, see "Using an extension hose for a sniffer tip [▶ 31]". The centering ring is contained in the shipment of a set with extension hoses for the sniffer tip.

Calibrate the device at least five minutes after switching it on. After the warm-up phase it is ensured that the device calibrates optimally.

6.3.6.2 Calibration with an internal COOL-Check

A COOL-Check has a life of about 2 years. It is announced on the basic unit that the life of the COOL-Check is running short 3 months before this time has elapsed. For this reason never keep a supply of COOL-Checks. Store the COOL-Check in a cool, dry place. See also "Change calibration leak (SMART only) [▶ 74]".





Fig. 12: Display when calibrating internally



- 1 To calibrate the device with the internal COOL-Check, switch to the measurement display .
- 2 There are 2 options:
 - ⇒ If you are prompted to calibrate then lead the sniffer tip into the calibration opening at the front of the basic unit. Calibration takes place automatically.
 - ⇒ If you are not prompted to calibrate, but wish to do so anyway then lead the sniffer tip into the calibration opening at the front of the basic unit whilst holding down the button on the sniffer probe. Calibration takes place automatically.

If the button on the sniffer probe is not pressed then the calibration is only checked, see “Checking the calibration with an internal COOL-Check [▶ 51]”.
- 3 Keep the sniffer line still and straight during calibration.
 - ⇒ The display shows individual calibration phases and informs you whether or not calibration was successful.

6.3.6.3 Calibrate with external calibration leak

The gas that leaks from the calibration leak is carried away by strong air currents. Keep this in mind when, for example, a fan blower is standing in your surroundings. Strong air currents provide false results when calibrating.

- 1  > Setup > Calibration leak external
- 2 Enter the leakage rate to calibrate for the tracer gas and confirm using . Details of leakage rates in various units can be found in the acceptance test certificate for the calibrated leak.
 - ⇒ Alternatively, set the desired leakage rate via the calibration display on the touchscreen, see also the following picture and step 5.

- 3 Switch to measurement screen .
- 4 For external calibration, select .

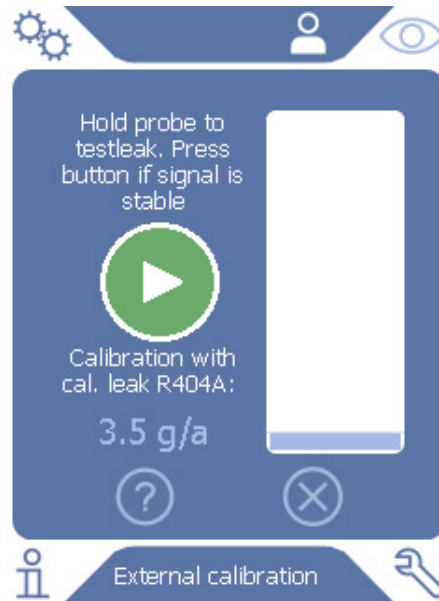

Fig. 13: Display for external calibration

- 5 If you wish to change the displayed leakage rate (in this example: 12.3 g/a) then this can be done after pressing a finger on this value. For more information see "Assembly of the touchscreen [▶ 15]".
 - 6 Hold the sniffer tip to the opening of the external test leak and start the calibration by pressing the green button on the touch screen or alternatively by pressing the button on the sniffer probe.
 - 7 Hold the sniffer line still and straight as long as the device is calibrating.
- ⇒ The display shows individual calibration phases and informs you whether or not calibration was successful.

6.3.6.4 Checking the calibration with an internal COOL-Check

The calibration can also be checked without changing calibration values. You can find out whether calibration is necessary.

- 1 Switch to measurement display.
- 2 Lead the sniffer tip into the calibration opening on the front of the basic unit without pressing the button on the sniffer probe.
- 3 Hold the sniffer line still and straight as long as the device is checking the calibration.
 - ⇒ A message appears stating whether the calibration is OK or whether the device requires recalibration.
 - ⇒ When the corresponding message appears on the measurement screen then press the button on the sniffer probe to calibrate.

6.4 Measuring

WARNING

Risk of electric shock from live parts

Electrical voltages can be transmitted via the sniffer probe and cause damage to property or personal injury.

- ▶ Do not touch live parts with the sniffer probe.
- ▶ Disconnect electrically operated test objects from the mains before starting the leak test and secure them against being restarted without authorization.

WARNING

Risk of eye damage

LEDs generate a bundled light that can damage your eyes.

- ▶ Do not look into the LEDs from a short distance or for longer periods of time.

CAUTION

Risk of electric shock from sucked liquids

Sucked up liquids can trigger short circuits and cause property damage or personal injury.

- ▶ Do not suck up liquids into the device.
- ▶ Use the water conservation tip in humid environments.

- ✓ A sniffer line is connected to the basic unit.
 - ✓ The device has started up and is warmed up, see "Switch ON [▶ 34]". An HLD6000 to which a PLUS sniffer line is connected must typically operate for at least 30 minutes to ensure full sensitivity.
 - ✓ The device is calibrated, see "Time and type of calibration [▶ 48]".
 - ✓ You have configured the measurement settings required for your measurement, see "Settings for the measurements [▶ 45]".
 - ✓ For difficult to reach places, you have used an extended and optionally flexible sniffer tip, see "Using flexible sniffer tip [▶ 30]".
 - ✓ Alternatively, you have an extension hose mounted on the front of your sniffer tip, see "Using an extension hose for a sniffer tip [▶ 31]".
- 1 Hold the sniffer tip close to the potential leak.
 - ⇒ The tip must touch the test object.

- 2 If you want to test a weld seam or similar, you must guide the tip along the path at a speed of less than 2.5 cm/s.
- 3 When you check a spot, hold the sniffer line to it for least 1 second.
- 4 If you have activated the button function on the sniffer probe, see "Setting up the sniffer probe [▶ 46]", then you have the following options:
 - ⇒ If the button is not pressed on the sniffer probe: Measurement takes setpoint 1 into consideration,
 - ⇒ If the button is pressed on the sniffer probe: Measurement takes setpoint 2 into consideration.



If you have activated the "Screenshot" function, see "Switching the "Screenshot" function on or off [▶ 43]", save a screenshot by pressing the button on the sniffer probe.

If the button function is enabled on the sniffer probe at this time, the screenshot is also saved when switching to setpoint 2.

If there is a leak, it will be reported in the displays with LEDs in the handle and - depending on your settings - also accompanied by an acoustic signal.

6.5 Measurement data



6.5.1 Measurement data recording

You can save measurement data as files in TXT format. The device creates a new TXT file every hour.

There is approx. 16 MB of free internal memory available. This is sufficient when setting up a 500 ms recording interval for approx. 24 hours.



Alternatively, measured data can be saved on a USB stick up to 32 GB (formatted in the FAT file system).

Starting recording

- 1  > Recorder > Recorder settings
 - ⇒ Alternatively, when on the touchscreen select the button .
- 2 Select from the following settings:
 - "Memory location": "USB" or "internal"
 - "Record interval": "100 ms", "200 ms", "500 ms", "1 s", "2 s" or "5s"
- 3 If "USB" is selected as the memory location then connect a USB stick with the USB port on the device.
- 4 Select the "On" button under "Data Record".
- 5 Start data recording by selecting the button .

- ⇒ If the device is switched off or the USB stick is removed from the USB memory location without finishing the data record then the data for the current hour being recorded is lost.

Stopping recording

- 1  > Recorder > Recorder settings
 - ⇒ Alternatively, when on the touchscreen select the button .
- 2 Press the "Off" button under "Data Record".
- 3 Stop data recording by selecting the button .

6.5.2 Evaluating measured data

A file with measurement data is structured as follows:

For example

```
// Record file: \L0000001.txt
// Created by HLD6000CU V0.11.02.18681
// HLD6000CU Ser.-No.: 00000000000
// HLD6000 Ser.-No.: 00000000000
// HLD6000MB V0.22.06(1.04.00)
// Probe V1.00
// Probe Ser.-No.: HLD5000 probe
// Probe Type: SMART (R134A)
// IO1000 V0.05.00(0.02.02)
// IO1000 Ser.-No.: 00000000000
// BM1000 not connected
// Start time: 23.06.2014 08:58:25
Time Leakrate[g/a] Status
0.0 1.82E-02 MEASURE
0.5 1.82E-02 MEASURE
1.0 4.16E-03 MEASURE
1.5 1.29E-02 MEASURE
2.0 0.00E+00 MEASURE
2.5 1.02E-02 MEASURE
3.0 1.75E-03 MEASURE
3.5 3.43E-03 MEASURE
4.0 3.43E-03 MEASURE
4.5 0.00E+00 MEASURE
5.0 8.20E-03 MEASURE
5.5 1.71E-02 MEASURE
6.0 1.52E-02 MEASURE
```

In the example shown the data record started on 06/23/2014 at 8:58:25. From this start time onwards a measurement result was recorded every 500 milliseconds.

1.82E-02 means 1.82×10^{-2} as the leakage rate per year.



The following status entries are possible:

Status entry	Meaning
UNKNOWN	Unknown, as, e.g., there is no communication
RUNUP	Run up

Status entry	Meaning
STANDBY	Standby
MEASURE	Measuring
ERROR (xxx)	Error (error number)
WARNING (xxx)	Warning (warning number)
CAL	Calibration



6.5.3 Transferring measured data from the internal memory to a USB stick

You can transfer measured data from the internal memory to a connected USB stick.

- 1 Connect a USB stick with the USB port on the device.
- 2  > Recorder > Copy
- 3 Select the files you wish to copy.
- 4 Confirm your selection with .

6.5.4 Deleting measurement data

If the internal memory has no more available space for the data record then measured data can be deleted.

- 1  > Recorder > Delete
- 2 Select the files you wish to delete.
- 3 Confirm your selection with .

6.6 Standby

The device switches to idle mode when you select the  button in the measurement display of the device.

Either pressing the  button or pressing the button on the sniffer probe will reactivate the device.

If the device was in standby mode for more than 25 seconds, you can activate the device by moving the sniffer line.

6.7 Diagnosis



To the list of active warnings

- ▶  > Active Warnings

Service

The service menu is password-protected. You can configure settings in the Service menu only after completing a special training course from the INFICON service department.

Histories

- 1  > Histories > Error And Warning History
- 2  > Histories > Calibration History

Update

- ▶  > Update

For further information on how to proceed with an update, see "Updating the software [▶ 59]".

6.8 Retrieve information about the device

It is possible to call up information regarding the parameters set and the operation modes of the device.





- 1 Select the navigation button .
- 2 Make a selection by pressing one of the following buttons:
 - Basic unit
 - COOL-Check
 - I/O module
 - Parameter list
 - Sniffer line
 - Operating unit
 - Bus module

⇒ The stored device-specific information is displayed.
- 3 View the desired information. These include, for example
 - ⇒ under "Basic Unit" there is information regarding the software version, the serial number of the device, the operating hours and the interior housing temperature,
 - ⇒ under "COOL-Check" there is information regarding the leakage rate depending on temperature and on the remaining time of use available,
 - ⇒ under "Sniffer Line" there is information regarding the software version, the serial number and the gas used,
 - ⇒ under "Operating Unit" there is information regarding the operating system and the software version.
- 4 To view all information, press on the page numbers displayed below.

6.9 Parameter list

It is possible to display all settings for the device. For changes the necessary permissions are required, see "Access to the settings [▶ 41]".

With the aid of the parameter list several changes can be carried out in one area without navigating through various menu trees, see "Menu path [▶ 82]".

- 1  > Parameter List
⇒ Alternatively, select " > Parameters > Parameter List".
- 2 To change individual parameters, press on an entry on the touchscreen.
- 3 Either confirm changes with  or reject them with the  button.

The following parameters are displayed:

- Analog output upper limit, see "Setting the upper scale value for 10 V of the analog output [▶ 39]"
- Display off after, see "Setting the display [▶ 36]"
- Display brightness, see "Setting the display [▶ 36]"
- Diagram maximum value (log.), see "Setting the display [▶ 36]"
- Diagram maximum value (lin.), see "Setting the display [▶ 36]"
- Display upper limit (lin.), see "Setting the display [▶ 36]"
- Display upper limit (log.), see "Setting the display [▶ 36]"
- Display unit leakage rate, see "Setting the display [▶ 36]"
- Auto scale, see "Setting the display [▶ 36]"
- Bus module address, see "Setting a bus module address [▶ 41]"
- Data record, see "Measurement data recording [▶ 53]"
- Date, see "Setting date and time [▶ 35]"
- Diagram of the leakage rate, see "Setting the display [▶ 36]"
- Factor user gas 1, see "Setting up the gas for the SMART sniffer line [▶ 46]"
- Factor user gas 2, see "Setting up the gas for the SMART sniffer line [▶ 46]"
- Factor user gas 3, see "Setting up the gas for the SMART sniffer line [▶ 46]"
- Error information operator, see "Setup scope of error messages [▶ 41]"
- Error information supervisor, see "Setup scope of error messages [▶ 41]"
- Filter change request, see "Setting the filter change request [▶ 38]"
- Filter change interval, see "Setting the filter change request [▶ 38]"
- Gas of R600a sniffer line, see "Verifying R290 with the sniffer line for R600a/R290 [▶ 48]"

- Gas of SMART sniffer line, see "Setting up the gas for the SMART sniffer line [▶ 46]"
- I/O module protocol, see "I/O module [▶ 38]"
- Auto standby interval, see "Setting auto standby [▶ 36]"
- Calibration request interval, see "Set time interval for calibration request [▶ 37]"
- Calibration factor, see "Calibrating [▶ 48]" (can only be changed by Service)
- Config. Analog output 1 - 2, see "Configuring analog outputs [▶ 38]"
- Configuration PLC Outputs 1 - 8, see "Configuring digital outputs [▶ 39]"
- Configuration PLC Inputs 1 - 10, see "Configure digital inputs [▶ 40]"
- Volume, see "Adjust volume [▶ 36]"
- Leakage rate setpoint 1, see "Setting setpoints [▶ 45]"
- Leakage rate setpoint 2, see "Setting setpoints [▶ 45]"
- Show measured value, see "Setting the display [▶ 36]"
- Module at M12 connector, see "I/O module [▶ 38]"
- Name user gas 1, see "Setting up the gas for the SMART sniffer line [▶ 46]"
- Name user gas 2, see "Setting up the gas for the SMART sniffer line [▶ 46]"
- Name user gas 3, see "Setting up the gas for the SMART sniffer line [▶ 46]"
- Phase, see "Calibrating [▶ 48]" (changeable by service)
- Calibration leak external, see "Calibrate with external calibration leak [▶ 50]"
- Interface unit leakage rate, see "Setting the interface unit [▶ 40]"
- Sniffer light alarm configuration, see "Setting up the sniffer probe [▶ 46]"
- Sniffer light brightness, see "Setting up the sniffer probe [▶ 46]"
- Probe key configuration, see "Setting up the sniffer probe [▶ 46]"
- Setpoint audio alarm, see "Setting up an alarm profile for setpoints [▶ 46]"
- Screenshot with probe key, see "Switching the "Screenshot" function on or off [▶ 43]"
- Record interval, see "Measurement data [▶ 53]"
- Memory location, see "Measurement data [▶ 53]"
- Language, see "Setting the language [▶ 35]"
- Time, see "Setting date and time [▶ 35]"
- Show warnings, see "Warning and error messages [▶ 63]" (can only be changed by Service)
- Value axis decades, see "Setting the display [▶ 36]"
- Value axis grid, see "Setting the display [▶ 36]"
- Time axis scale, see "Setting the display [▶ 36]"

6.10 Resetting to factory settings

You can reset the device to the factory settings, separately for the settings of the operating unit, the basic unit or the parameter access level.



Loss of settings and access rights

After resetting to factory settings only the manufacturer factory settings are in the memory of the device. The software of the device is not reset when restoring the factory settings.

1  > Parameter > Reset

2 Make your choice:

- ⇒ If you want to reset operating unit settings such as display settings, press the "Reset" button next to the "Operating unit settings". See also "Factory settings [▶ 23]".
- ⇒ For example, if you want to reset measurement settings such as setpoints, press the "Reset" button next to the "Basic unit settings". See also "Factory settings [▶ 23]".
- ⇒ If you want to restore the factory settings for access, press the "Reset" button next to "Parameter access level". See also "Factory settings [▶ 23]", Table 2.
- ⇒ To reset the device to the factory settings, press all "Reset" buttons one after the other.

See also

 Save parameters [▶ 43]

6.11 Updating the software

Software updates from INFICON are installed with the aid of a USB stick. To the update function of the device:

▶  > Update

An update is possible,

- if one or several updates are available on the USB stick, but only one update per type at most (basic unit, operating unit, sniffer line, I/O module),
- if in the case of the "sniffer line" or the "I/O module" these parts are also connected free of disturbances and have an update function.

The corresponding buttons in the update menu such as "Basic Unit", "Operating Unit", "Sniffer Line" and "I/O Module" are active and can be activated individually.

Inactive buttons can be recognized as they are in gray.

NOTICE



Data loss due to an aborted connection

- ▶ Do not switch off the device and do not remove the USB flash drive while the software is being updated!

- ▶ Switch the device off and back on after a software update has taken place.

6.11.1 Updating the software of the basic unit

The software is included in the file named "Flash_HLD6000_Main_Vxx.xx.xxx.bin".

- 1 Copy the file into the main directory of a USB flash drive.
- 2 Connect the USB flash drive to the USB port on the device.
- 3  > Update > Basic Unit
 - ⇒ The display shows information on the current and the new software as well as on the current boot loader.
- 4 Check the version information.
- 5 Select the "Start" button to start the update.
- 6 Do not switch off the device and do not remove the USB flash drive while the software is being updated!
- 7 Follow the instructions on the touchscreen and wait until the update is complete.
- 8 If the system displays warning 104 or 106, close it with .

6.11.2 Updating the software of the operating unit

The software is included in 2 files named HLD6000CU_IFC_Vx.xx.xx.exe and HLD6000CU_IFC_Vx.xx.xx.button.

- 1 Copy the files into the main directory of a USB stick.
- 2 Connect the USB flash drive to the USB port on the device.
- 3  > Update > Operating Unit
 - ⇒ The display shows information on the current and the new software version.
- 4 Check the version information.
- 5 Select the "Start" button to start the update.
 - ⇒ Do not switch off the device and do not remove the USB flash drive while the software is being updated!
- 6 Follow the instructions on the touchscreen and wait until the update is complete.

6.11.3 Updating the software of the sniffer line

The software on the HLD6000 sniffer line can be updated from the basic unit provided that the sniffer line is connected and works perfectly.

The software is included in the file named "Flash_HLD6000_Probe_Vxx.xx.xxx.bin".

- 1 Copy the file into the main directory of a USB flash drive.
- 2 Connect the USB flash drive to the USB port on the device.
- 3  > Update > Sniffer Line
 - ⇒ The display shows information on the current and the new software as well as on the current boot loader.
- 4 Check the version information.
- 5 Select the "Start" button to start the update.
 - ⇒ Do not switch off the device and do not remove the USB flash drive while the software is being updated!

6.11.4 Updating the software of the I/O module

The software on the I/O module can be updated from the HLD6000 provided that the I / O - module is connected and works perfectly.

The software is included in the file named "Flash_IO1000_Vxx.xx.xxx.bin".

- 1 Copy the file into the main directory of a USB flash drive.
- 2 Connect the USB flash drive to the USB port on the device.
- 3  > Update > I/O Module
 - ⇒ The display shows information on the current and the new software as well as on the current boot loader.
- 4 Check the version information.
- 5 Select the "Start" button to start the update.
 - ⇒ Do not switch off the device and do not remove the USB flash drive while the software is being updated!
- 6 Follow the instructions on the touchscreen and wait until the update is complete. The following tips are shown after selecting the "Start" button on the touchscreen:
 - ⇒ Connect and switch on the IO1000.
 - ⇒ Activate boot mode (switch DIP S2.3 on and off once).
 - ⇒ When the STATUS LED flashes green, press OK.

6.12 Switch OFF

You can switch off the device at the mains switch at any time. The parameters set in the device remain saved.

7 Warning and error messages

During operation, the display shows information that helps you operate the device. Measurement values are displayed along with current device modes, operating instructions as well as warnings and error messages.

The device is equipped with extensive self-diagnostic functions. If the electronics detect a faulty state, the device will show this as far as possible on the display and will interrupt operation when necessary.

Warnings

Warnings warn of device states that can impair the accuracy of measurements. Operation of the instrument is not interrupted.

Pressing the "X" button acknowledges the warning.

Error messages

Errors are events that the device cannot correct itself and that force interruption of its operation. The error message consists of a number and a descriptive text.

If you have eliminated the cause of the error, then start operation again by pressing the button .

The following table displays all the warnings and error messages. It states possible causes for the malfunction and instructions on troubleshooting.

No.	Message	Possible error sources	Troubleshooting
1xx system error			
W102	Timeout of EEPROM basic unit	Basic unit EEPROM defective.	Contact INFICON customer service.
W104	An EEPROM parameter is initializing	<ul style="list-style-type: none"> A new parameter was introduced by a software update. If the message occurs constantly during running up, the EEPROM on the basic unit is defective. 	<ul style="list-style-type: none"> Confirm the warning. Check whether the factory settings correspond with the new parameter of your application. Contact INFICON customer service.
W106	EEPROM parameter initializing	<ul style="list-style-type: none"> A software update introduced new parameters. The motherboard was replaced. If the message occurs constantly during running up, the EEPROM on the basic unit is defective. 	<ul style="list-style-type: none"> Confirm the warning. Check whether the settings correspond with your application. Please contact INFICON customer service
E107	Internal IIC communication error	Internal defect	Please contact INFICON customer service

No.	Message	Possible error sources	Troubleshooting
W110	Clock not set	Clock jumper not set, battery empty or clock defective.	Contact INFICON customer service.
W111	Many EEPROM write cycles within the last 6 minutes	<ul style="list-style-type: none"> • Within the last 6 minutes too many write commands were sent to the device from an external controller • Too many settings were changed within the last 6 minutes 	<ul style="list-style-type: none"> • Check the programming of your external control • Change settings only if necessary
W122	No response from bus module	Connection to BUS module interrupted	Check the connection to the BUS module.
W125	I/O module no longer connected	Connection to I/O module was interrupted.	Check the connection to the I/O module.
W126	Protocol not supported by I/O module software	The I/O module software does not support the selected HLD5000 protocol.	Make a software update of the I/O module to a newer version.
W127	Wrong bootloader version	The boot loader software is not compatible with the application.	Contact INFICON customer service.
E130	Sniffer line not connected	The sniffer line cannot be addressed by the basic unit.	<ul style="list-style-type: none"> • Check the connection of the sniffer line with the basic unit (disconnect and reconnect; if possible try a different sniffer line). • If the problem persists, contact the INFICON customer service.
E131	Wrong parameter in the sniffer line	The parameters stored in the sniffer line are wrong.	Contact INFICON customer service.
E132	Unsupported old sniffer line	An old sniffer line is connected which is not supported.	Use a current sniffer line.
E133	EEPROM error in sniffer line	The EEPROM of the sniffer line is defective	Contact INFICON customer service.
E134	Protocol error while communicating with the sniffer line	The interface to the sniffer line is not working correctly.	<ul style="list-style-type: none"> • Check the connection of the sniffer line with the basic unit (disconnect and reconnect; if possible try a different sniffer line). • If the problem persists, contact the INFICON customer service.

No.	Message	Possible error sources	Troubleshooting
E135	Check sum error while communicating with sniffer line	<ul style="list-style-type: none"> The interface to the sniffer line does not function reliably. Possible electrical sources of disturbance close by. 	<ul style="list-style-type: none"> Check the connection of the sniffer line with the basic unit (disconnect and reconnect; if possible try a different sniffer line). Eliminate sources of disturbance If the problem persists, contact the INFICON customer service.
E136	No answer from sniffer line	The interface to the sniffer line is not working correctly.	<ul style="list-style-type: none"> Check the connection of the sniffer line with the basic unit (disconnect and reconnect; if possible try a different sniffer line). If the problem persists, contact the INFICON customer service.
E137	Sniffer line reset	<ul style="list-style-type: none"> The sniffer line has reset itself. Possible electrical sources of disturbance close by. The sniffer line is not connected correctly. 	<ul style="list-style-type: none"> Eliminate sources of disturbance Check the connection of the sniffer line with the basic unit (disconnect and reconnect; if possible try a different sniffer line). If the problem persists, contact the INFICON customer service.
E138	Check sum error in sniffer line EEPROM	The EEPROM of the sniffer line has incorrect data or is defective.	Contact INFICON customer service.
E139	Empty EEPROM in the sniffer line	The EEPROM of the sniffer line has no data or is defective.	Contact INFICON customer service.
W140	Acceleration of the probe was permanently too high within the last 5 minutes	<ul style="list-style-type: none"> The sniffer line is not lying still. Sniffer line defective. 	<ul style="list-style-type: none"> Place the sniffer line on a steadier surface. Contact INFICON customer service.
E141	Probe / sensor mismatch	The EEPROM of the sniffer line has incorrect data or is defective.	Contact INFICON customer service.
W151	No communication with operating unit	Internal connection problems between the basic unit and the operating unit.	Contact INFICON customer service.
W153	Software of the operating unit is outdated	Software of the operating unit is outdated	Install the latest operating unit software

No.	Message	Possible error sources	Troubleshooting
W163	COOL-Check is not connected	COOL-Check not connected or not properly connected.	<ul style="list-style-type: none"> • Connect a COOL-Check, otherwise confirm the warning and calibrate externally. • Check the COOL-Check connection.
W164	Checksum error in COOL-Check	<ul style="list-style-type: none"> • The COOL-Check is not connected correctly. • The COOL-Check or the basic unit is defective. 	<ul style="list-style-type: none"> • Check the COOL-Check connection. • Check the connection of the COOL-Check to basic unit (separate and reconnect; try another COOL-Check, if possible). • If the problem persists, contact the INFICON customer service.
E165	Timeout of EEPROM COOL-Check	<ul style="list-style-type: none"> • The COOL-Check is not connected correctly. • The COOL-Check or the basic unit is defective. 	<ul style="list-style-type: none"> • Check the COOL-Check connection • Check the connection of the COOL-Check to basic unit (separate and reconnect; try another COOL-Check, if possible). • If the problem persists, contact the INFICON customer service.
W166	Audio amplifier is faulty	Error in the internal audio amplifier	Contact INFICON customer service.
2xx voltage error			
W220	Voltage +24V out of range	<ul style="list-style-type: none"> • Line error on the M12 socket or the module connected there. • Internal defect. 	<ul style="list-style-type: none"> • Check the connections. • Contact INFICON customer service.
W230	Voltage +3.3V out of range	Internal defect.	Contact INFICON customer service.
W240	Voltage +12V out of range	<ul style="list-style-type: none"> • Sniffer line defective. • Internal defect. 	<ul style="list-style-type: none"> • Check the connection of the sniffer line with the basic unit (disconnect and reconnect; if possible try a different sniffer line). • If the problem persists, contact the INFICON customer service.

No.	Message	Possible error sources	Troubleshooting
W241	Voltage -12V out of range	<ul style="list-style-type: none"> Sniffer line defective. Internal defect. 	<ul style="list-style-type: none"> Check the connection of the sniffer line with the basic unit (disconnect and reconnect; if possible try a different sniffer line). If the problem persists, contact the INFICON customer service.
W250	Voltage +5V out of range	Internal defect	Contact INFICON customer service.
W253	Wrong sniffer line voltage	Sniffer line defective.	<ul style="list-style-type: none"> Check the connection of the sniffer line with the basic unit (disconnect and reconnect; if possible try a different sniffer line). If the problem persists, contact the INFICON customer service.
3xx Measurement system error			
W322	Lamp voltage out of range	<ul style="list-style-type: none"> Sniffer line connection or sniffer line is defective. Internal defect in the basic unit. 	<ul style="list-style-type: none"> Check the connection of the sniffer line with the basic unit (disconnect and reconnect; if possible try a different sniffer line). If the problem persists, contact the INFICON customer service.
W324	Lamp current out of range	<ul style="list-style-type: none"> Sniffer line connection or infra-red source in the sniffer line is defective. Internal defect in the basic unit. 	<ul style="list-style-type: none"> Check the connection of the sniffer line with the basic unit (disconnect and reconnect; if possible try a different sniffer line). If the problem persists, contact the INFICON customer service.
W363	Sensitivity too low	<ul style="list-style-type: none"> Optical cell is contaminated with water vapor. The optical cell is dirty The sensor in the sniffer line is defective. 	<ul style="list-style-type: none"> Depending on the quantity of water inside the optical cell, let the HLD6000 run between one minute and two hours to clean the optical cell. If the problem persists, contact the INFICON customer service.
W364	Sensitivity too high	Sniffer line defective.	Contact INFICON customer service.
5xx Flow and pressure errors			

No.	Message	Possible error sources	Troubleshooting
W543	Flow in the sniffer line is too low	<ul style="list-style-type: none"> • Filter in the sniffer tip is clogged • Sniffer tip is clogged or defective • Internal filter of sniffer line blocked (only PLUS sniffer line) 	<ul style="list-style-type: none"> • Change the filters, see also "Replacing the filter plates [▶ 71]" and "Cleaning the calibration opening [▶ 72]". • Check the connection of the sniffer line with the basic unit (disconnect and reconnect; if possible try a different sniffer line). • If the problem persists, contact the INFICON customer service.
W544	Valve does not toggle	Internal defect of the sniffer line.	<ul style="list-style-type: none"> • Check the connection of the sniffer line with the basic unit (disconnect and reconnect; if possible try a different sniffer line). • If the problem persists, contact the INFICON customer service.
W545	Flow at measuring line too low	<ul style="list-style-type: none"> • The filter in the sniffer tip is clogged. • Sniffer tip is clogged or defective. • Internal filter of sniffer line blocked (only PLUS sniffer line) 	<ul style="list-style-type: none"> • Replace the filters • Check the connection of the sniffer line with the basic unit (disconnect and reconnect; if possible try a different sniffer line). • If the problem persists, contact the INFICON customer service.
W546	Leak at measuring line	<ul style="list-style-type: none"> • The filter in the sniffer tip is clogged. • Leak or defect in the sniffer tip or the sniffer line. 	<ul style="list-style-type: none"> • Replace the filters. • Check the plug and screw connections. • Check the connection of the sniffer line with the basic unit (disconnect and reconnect; if possible try a different sniffer line). • If the problem persists, contact the INFICON customer service.

No.	Message	Possible error sources	Troubleshooting
W547	Flow at reference line too low	<ul style="list-style-type: none"> Filter in the sniffer tip is clogged. The sniffer tip is clogged or defective. 	<ul style="list-style-type: none"> Replace the filters. Check the connection of the sniffer line with the basic unit (disconnect and reconnect; if possible try a different sniffer line). If the problem persists, contact the INFICON customer service.
W548	Leak at reference line	<ul style="list-style-type: none"> The filter in the sniffer tip is clogged. Leak or defect in the sniffer tip or the sniffer line. 	<ul style="list-style-type: none"> Replace the filters Check the plug and screw connections. Check the connection of the sniffer line with the basic unit (disconnect and reconnect; if possible try a different sniffer line). If the problem persists, contact the INFICON customer service.
W549	Measuring and reference line are swapped	<ul style="list-style-type: none"> Poor calibration. Internal defect on the sniffer line. 	<ul style="list-style-type: none"> Recalibrate the device. Contact INFICON customer service.
6xx Calibration errors			
W630	Calibration request	Calibration out of date or no longer applicable.	<ul style="list-style-type: none"> Recalibrate the device. Select a suitable interval in the menu for the calibration request.
W631	Light barrier overdriven	The light barrier in the calibration opening gets too much light.	Avoid direct light and sunlight to the calibration opening.
W632	Light barrier blocked during run-up	Dust has accumulated in the calibration opening and is interrupting the light barrier.	<ul style="list-style-type: none"> Switch the instrument off. Blow out the calibration opening with clean compressed air. Restart the device. <p>If this does not work, then calibrate externally with the COOL-Check or an external calibration leak.</p>
7xx Temperature errors			
E709	Mainboard temperature too low	The temperature sensor is defective	Please contact INFICON customer service

No.	Message	Possible error sources	Troubleshooting
W710	Temperature main board too high	<ul style="list-style-type: none"> The ambient temperature is too high. The fan is defective or blocked. 	<ul style="list-style-type: none"> Decrease the temperature around the device. Clean the ventilation openings or replace the filter plates. Contact INFICON customer service.
E711	Temperature main board far too high	<ul style="list-style-type: none"> The ambient temperature is too high. The fan is defective or blocked. 	<ul style="list-style-type: none"> Switch off the device and allow it to cool down. Decrease the temperature around the device. Clean the ventilation openings or replace the filter plates. Contact INFICON customer service.
W730	Temperature COOL-Check out of range	<ul style="list-style-type: none"> The basic unit is standing on a hot surface. The temperature around the main unit is too high or too low. 	<ul style="list-style-type: none"> Remove the device from the hot surface. Decrease or increase the temperature around the device.
9xx Maintenance information			
W902	COOL-Check is almost empty	<ul style="list-style-type: none"> The COOL-Check is empty. The basic unit is set to a wrong date. 	<ul style="list-style-type: none"> Change the COOL-Check. Set the basic unit to the current date.
W903	COOL-Check is empty	<ul style="list-style-type: none"> The COOL-Check is empty. The basic unit is set to a wrong date. 	<ul style="list-style-type: none"> Change the COOL-Check. Set the basic unit to the current date.
W904	Replace the filter holder at sniffer tip	The filter of sniffer tip should be changed.	<ul style="list-style-type: none"> Replace the filters. Select a suitable interval in the "Filter change request" menu.

8 Maintenance

Carry out maintenance work on the device in accordance with the following description.

DANGER

Life threatening hazard from electric shock

High voltages are inside the device. Touching parts where electrical voltage is present can result in death.

- ▶ Disconnect the device from the power supply prior to any maintenance work.
- ▶ Ensure that the electrical supply cannot be switched back on unintentionally.

A Phillips-tip screwdriver is needed for some maintenance work.

8.1 Basic unit

8.1.1 Replacing the filter plates

Spare filter plates	Order no. 200 005 506
Required tools	Screwdriver

Two filter plates on the base of the device filter dust out of the sucked-in air. If the filters are not replaced regularly then they become clogged. Functioning filters are required to cool the device.

For this reason, check the filter plates frequently for dirt.

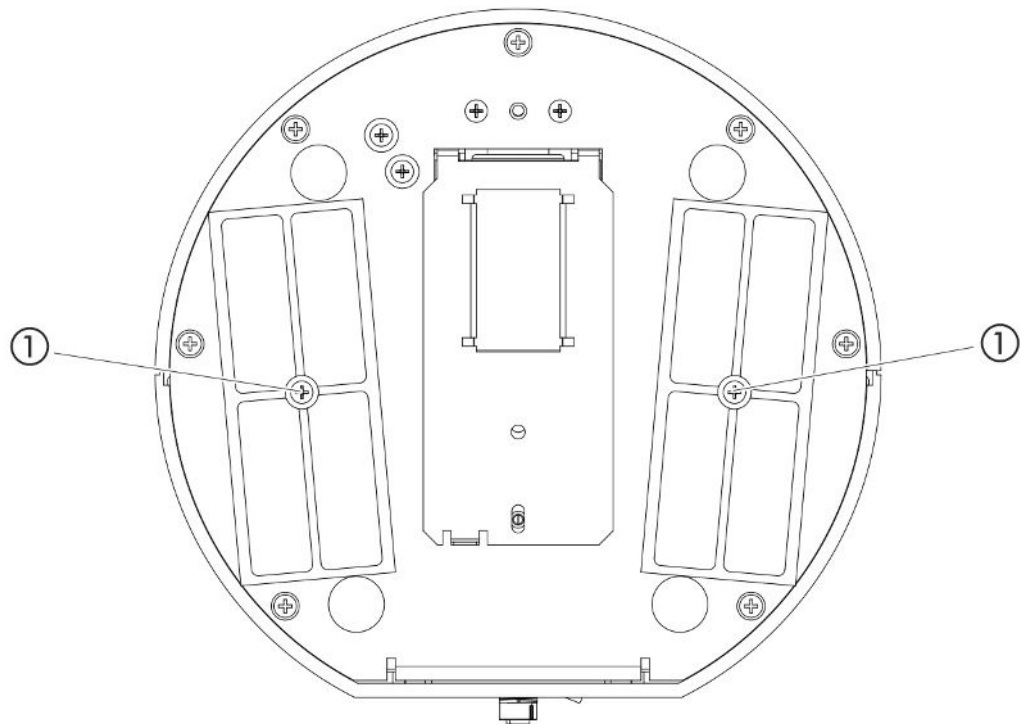

Fig. 14: View from below

- | | |
|---|--|
| 1 | Screws for holding the cover for the filters |
|---|--|

DANGER

Life threatening hazard from electric shock

- ▶ Disconnect the device from the power supply prior to any maintenance work.

- 1 Make sure that the device is disconnected from the power supply.
- 2 Turn the device carefully to its side.
- 3 Loosen the two screws in the middle of the filter holder, see figure above (view from below).
- 4 Remove the filter plates.
- 5 Clean the filter plates depending on the degree of pollution (e.g. with clean, compressed air or a brush) or replace the filter plates.
- 6 Reinstall the filter plates.
- 7 Tighten the screws in the middle of the filter holder.

8.1.2 Cleaning the calibration opening

A light barrier can be found in the calibration opening on the front of the basic unit, see "Basic unit [▶ 13]", (front view).

- ▶ To prevent interruption of the light barrier due to pollution, blow out the calibration frequently with clean, compressed air.

8.1.3 Replacing the fuses

The fuse holder of the device can be found beneath a cover alongside the mains plug at the back, .see "Basic unit [▶ 13]", (rear view).

Replace the fuses as follows:

DANGER

Life threatening hazard from electric shock

- ▶ Disconnect the device from the power supply prior to any maintenance work.

- 1 Make sure that the device is disconnected from the power supply.
- 2 Carefully pull the cover out of the device with the fuses attached beneath until the fuse holder can be tipped over to one side.
- 3 Remove the fuses and check them for any damage.
- 4 If necessary, replace the fuses. The two fuses used must be exactly the same, see "Technical specifications [▶ 21]".
- 5 Press the fuse holder along with the fuses back into the starting position until the cover locks into place.

8.1.4 Cleaning the device

The housing of the device is composed of synthetic material.

- 1 Switch off the device and disconnect from the mains.
- 2 When cleaning the housing, use an agent accepted for synthetic surfaces (for example a light household cleaner). Do not use any solvents that attack synthetic materials.

8.1.5 Change calibration leak (SMART only)

COOL-Check	Order no. 511-010
Required tools	None

Note on the biennial maintenance cycle: This time of use is reduced after prolonged storage.

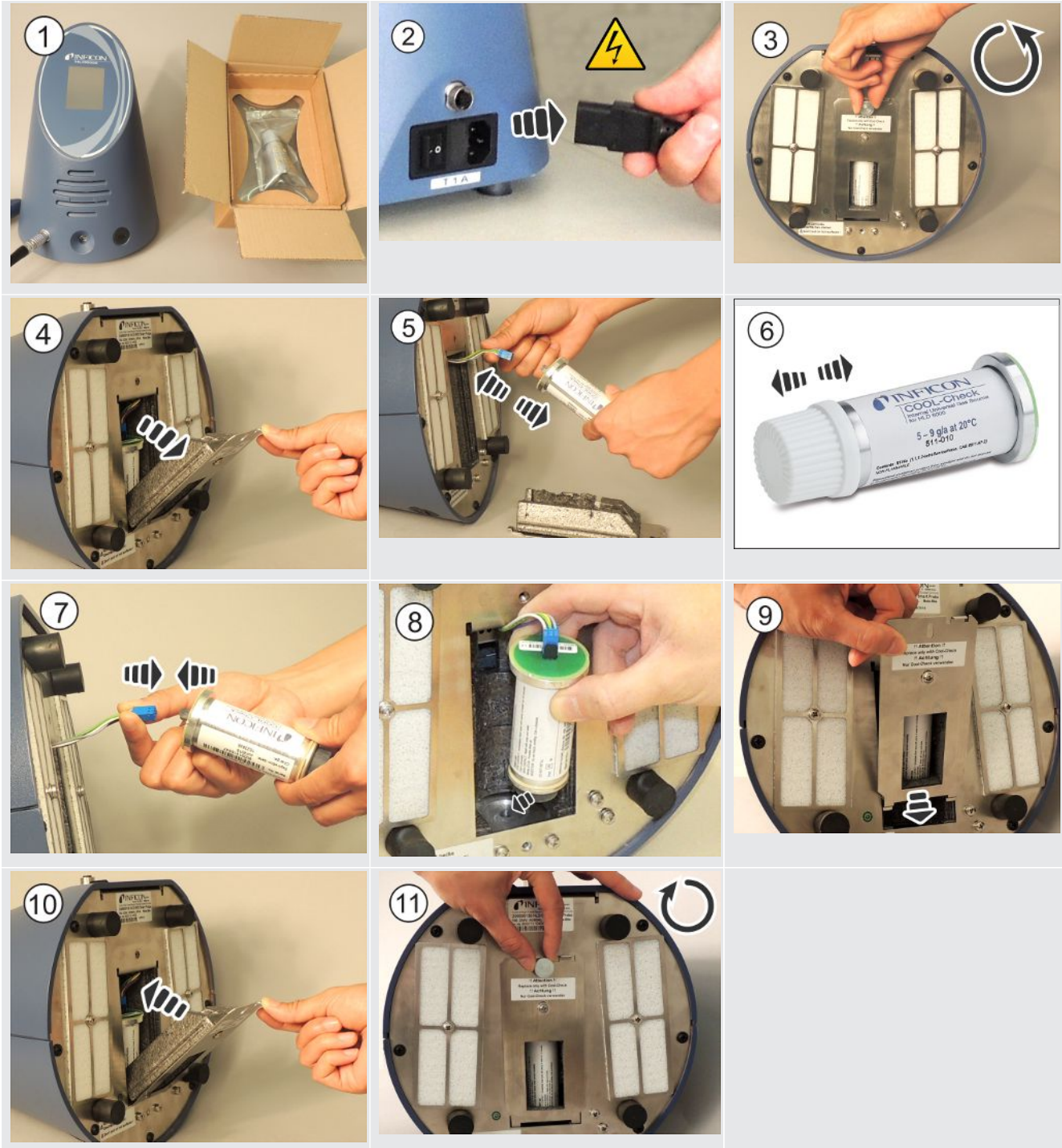



Lifetime of COOL-Checks

A COOL-Check has a lifetime of about 2 years. It is announced on the basic unit that the life of the COOL-Check is running short 3 months before this time has elapsed. For this reason never keep a supply of COOL-Checks. Store the COOL-Check in a cool, dry place.

Due to residues of the refrigerant, an old COOL check can still be under high pressure. An expired COOL-Check must therefore be disposed of in compliance with all environmental protection regulations. You can send it to INFICON or to your supplier for disposal.

8.2 Sniffer line

NOTICE

Material damage from compressed air

Compressed air can damage tine inside of the sniffer line.

- ▶ Never try to clean the probe or the filter holder with compressed air.

The following filters are installed in the sniffer line (Standard and PLUS) of the device:

- Filter holder with fine filters in the sniffer tip,
- Filter block with fine filters at the base of the sniffer tip.

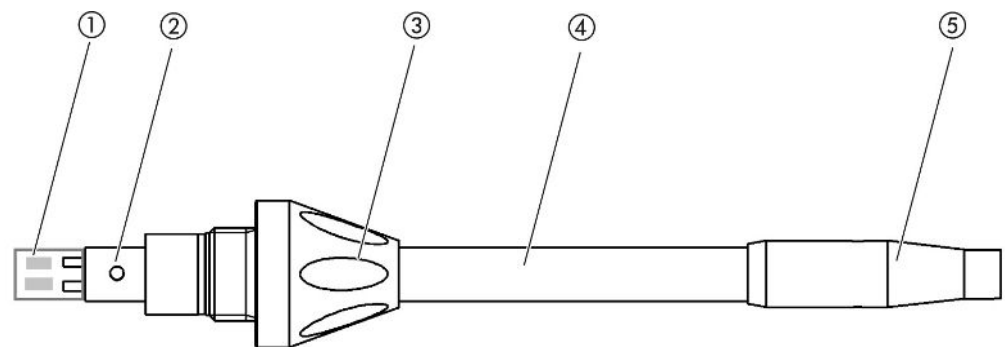

Fig. 15: The filters in the sniffer line

1	Filter block
2	Guide pin
3	Union nut
4	Sniffer tip
5	Filter holder



A sniffer line PLUS has another filter built into the handle, which does not need to be renewed by the customer. If you still receive an error message about the PLUS filter, contact customer service.

8.2.1 Replacing the filter holder (all sniffer lines)

Filter holder (20 units)	Order no. 511-027
Required tools	None

Replace the filter holder regularly after 40 operating hours. The fine filters in the sniffer tip are built into the filter holder, see "Sniffer line [▶ 75]", (The filters in the sniffer line).

- 1 Switch the instrument off.
- 2 Unscrew the filter holder from the sniffer tip.
- 3 Screw a new filter holder into position.



To receive an automatic request to change the filter after 40 operating hours, activate this function in the device settings (see "Setting the filter change request [▶ 38]"). When the filter holder has been changed and the request is confirmed then this function is reset. The request then reappears after 40 hours.

Regardless of the elapsed time, the device issues a warning or error message in case of pollution.

8.2.2 Replacing the filter block (all sniffer lines)

Filter block for the sniffer tip (20 units)	Order no. 511-018
Required tools	None

Change the filter block with the integrated fine filters at least 1 x per month.

The filter block can be found at the base of the sniffer tip, see "Sniffer line [▶ 75]", (The filters in the sniffer line).

- 1 Switch the instrument off.
- 2 Loosen the cap nut at the lower end of the sniffer tip and separate the sniffer tip from the probe handle.
- 3 Pull the filter block out of the base of the sniffer tip.
- 4 Insert a new filter block into position.
- 5 Attach the sniffer tip back onto the probe handle and tighten the cap nut at the lower end of the sniffer tip.

8.3 Sending for repair or maintenance

You can send in your device to INFICON so it can be maintained or repaired. For further information regarding this topic see "Sending in the device [▶ 78]".

8.4 Maintenance table

Maintenance cycle	Personnel	Additional information	
Two-yearly	Operating personnel	8.1.5	Change calibration leak (SMART only)
If soiled	Operating personnel	8.1.1	Replacing the filter plates
		8.2.2	Replacing the filter block (all sniffer lines)
40 h	Operating personnel	8.2.1	Replacing the filter holder (all sniffer lines)

9 Decommissioning

9.1 Disposing of the device

The operator can dispose of the device or it can be sent to INFICON.

The device consists of materials that can be recycled. This option should be exercised to prevent waste and also to protect the environment.

During disposal, observe the environmental and safety regulations of your country.

9.2 Sending in the device



WARNING

Danger due to harmful substances

Contaminated devices could endanger the health. The contamination declaration serves to protect all persons who come into contact with the device.

▶ Fill in the declaration of contamination completely.

- 1** Please do not hesitate to contact the manufacturer and send a completed declaration of contamination before sending anything to us.
⇒ You will then receive a return number.
- 2** Use the original packaging when returning.
- 3** Before sending the device, attach a copy of the completed contamination declaration. See below.

Declaration of Contamination

The service, repair, and/or disposal of vacuum equipment and components will only be carried out if a correctly completed declaration has been submitted. Non-completion will result in delay.
 This declaration may only be completed (in block letters) and signed by authorized and qualified staff.

1 Description of product

Type _____

Article Number _____

Serial Number _____

2 Reason for return

3 Operating fluid(s) used (Must be drained before shipping.)

4 Process related contamination of product:

toxic	no <input type="checkbox"/> 1)	yes <input type="checkbox"/>	<p>2) Products thus contaminated will not be accepted without written evidence of decontamination!</p>
caustic	no <input type="checkbox"/> 1)	yes <input type="checkbox"/>	
biological hazard	no <input type="checkbox"/>	yes <input type="checkbox"/> 2)	
explosive	no <input type="checkbox"/>	yes <input type="checkbox"/> 2)	
radioactive	no <input type="checkbox"/>	yes <input type="checkbox"/> 2)	
other harmful substances	no <input type="checkbox"/> 1)	yes <input type="checkbox"/>	

The product is free of any substances which are damaging to health
 yes

1) or not containing any amount of hazardous residues that exceed the permissible exposure limits

5 Harmful substances, gases and/or by-products

Please list all substances, gases, and by-products which the product may have come into contact with:

Trade/product name	Chemical name (or symbol)	Precautions associated with substance	Action if human contact

6 Legally binding declaration:

I/we hereby declare that the information on this form is complete and accurate and that I/we will assume any further costs that may arise. The contaminated product will be dispatched in accordance with the applicable regulations.

Organization/company _____

Address _____ Post code, place _____

Phone _____ Fax _____

Email _____

Name _____

Date and legally binding signature _____ Company stamp _____

Copies:
 Original for addressee - 1 copy for accompanying documents - 1 copy for file of sender

10 Appendix









10.1 Accessories and spare parts

		Order no.
Basic unit		
	Filter plate 133x55x3mm, 10 units	200 005 506
Sniffer line standard		
	R744 (CO ₂)	511-045
	R600a/R290	511-048
	SMART (gas family of the HFC refrigerant)	511-047
PLUS sniffer line		
	R600a/R290 PLUS	511-148
	SMART PLUS (gas family of the HFC refrigerant)	511-147
Sniffer tip		
	100 mm long, rigid, includes 6 filter holders and 5 filter blocks	511-021
	400 mm long, bent, includes 6 filter holders and 5 filter blocks	511-022
	400 mm long, flexible, includes 6 filter holders and 5 filter blocks	511-024
Extension hoses for the sniffer tip		
	400 mm, flexible (20 units), including 1 centering ring and 1 adapter	511-020
	400 mm, 45° angled (20 units), including 1 centering ring and 1 adapter	511-029
Filter for the sniffer tip		
	Filter holder for the sniffer tip (20 units)	511-027
	Filter block for the sniffer tip (20 units)	511-018
	Extension of the sniffer line, 4.8 m	511-040
	S-TL adapter for CO ₂ calibration, including 1 WK31/2 filter and 1 plastic hose, 2 m	511-042
	Water conservation tip	511-025
	COOL-Check calibration leak for SMART	511-010
External calibration leaks for individual coolants		
	R744 (CO ₂), leakage rate 2 - 5 g/a	122 32
	R744 (CO ₂), leakage rate 10 -14 g/a	122 75





















	R600a, leakage rate 3 - 5 g/a	122 21
	R290, leakage rate 7 - 8 g/a	122 31
Module		
	I/O module	560-310
	BM1000 Profibus module	560-315
	BM1000 PROFINET IO module	560-316
	BM1000 Device Net module	560-317
	BM1000 Ethernet/IP module	560-318
	Data cable LD 2 m	560-332
	Data cable LD 5 m	560-335
	Data cable LD 10 m	560-340















10.2 Menu path

10.2.1 Diagnosis







- 1  > Active Warnings
- 2  > Update
- 3  > Update > Operating Unit
- 4  > Update > Basic Unit
- 5  > Update > I/O Module
- 6  > Update > Sniffer Line
- 7  > Histories > Error And Warning History
- 8  > Histories > Calibration History

10.2.2 Settings

- 1  > Access Ctrl. > Operator
- 2  > Access Ctrl. > Supervisor
- 3  > Access Ctrl. > Supervisor > PIN Assign
- 4  > Setup > Language
- 5  > Setup > Request
- 6  > Setup > Auto Standby
- 7  > Setup > General > Date and Time
- 8  > Setup > Advanced setup > Error information
- 9  > Setup > Advanced setup > SMART user gases
- 10  > Setup > Calibration leak external
- 11  > Set Up > Sniffer line
- 12  > Display Settings
- 13  > Display settings > Screenshot
- 14  > Gas
- 15  > Volume
- 16  > Parameter > Load
- 17  > Parameter > Parameter list
- 18  > Parameter > Parameter access level
- 19  > Parameter > Reset
- 20  > Parameter > Save

- 21  > Recorder > Recorder settings
- 22  > Recorder > Copy
- 23  > Recorder > Delete
- 24  > Setup > Interfaces > Bus module > Adress
- 25  > Setup > Interfaces > Device selection
- 26  > Setup > Interfaces > I/O module > Analog scale
- 27  > Setup > Interfaces > I/O module > Analog outputs
- 28  > Setup > Interfaces > I/O module > PLC outputs
- 29  > Setup > Interfaces > I/O module > PLC inputs
- 30  > Setup > Interfaces > I/O module > Units
- 31  > Setup > Interfaces > I/O module > Protocol
- 32  > Setpoints > Leakage Rate Setpoint 1
- 33  > Setpoints > Leakage Rate Setpoint 2
- 34  > Setpoints > Setpoint alarm

10.2.3 Information

- 1  > Bus module
- 2  > COOL-Check
- 3  > Operating unit
- 4  > Basic unit
- 5  > I/O module
- 6  > Parameter List
- 7  > Sniffer line

10.3 CE Declaration of Conformity



EU Declaration of Conformity

We – INFICON GmbH - herewith declare that the products defined below meet the basic requirements regarding safety and health and relevant provisions of the relevant EU Directives by design, type and the versions which are brought into circulation by us. This declaration of conformity is issued under the sole responsibility of INFICON GmbH.

In case of any products changes made without our approval, this declaration will be void

Designation of the product:

Halogen Sniffer Leak Detector

Models: **HLD6000**

The products meet the requirements of the following Directives:

- **Directive 2014/35/EU (Low Voltage)**
- **Directive 2014/30/EU (Electromagnetic Compatibility)**
- **Directive 2011/65/EC (RoHS)**

Applied harmonized standards:

- **EN 61010-1:2010**
- **EN 61326-1:2013**
Class B according to EN 55011
- **EN IEC 63000:2018**

Catalogue numbers:

510-025

510-027, 510-127

510-028, 510-128

Cologne, August 20th, 2020

Cologne, August 20th 2020

Dr. Döbler, President LDT



INFICON GmbH
Bonner Strasse 498
50968 Köln (Bayenthal)
Deutschland

Bausch, Research and Development

INFICON GmbH
Bonner Strasse 498
D-50968 Cologne
Tel.: +49 (0)221 56788-0
Fax: +49 (0)221 56788-90
www.inficon.com
E-mail: leakdetection@inficon.com

10.4 RoHS

Restriction of Hazardous Substances (China RoHS)

有害物质限制条例（中国 RoHS）

		HLD6000: Hazardous Substance HLD6000: 有害物质				
Part Name 部件名称	Lead (Pb) 铅	Mercury (Hg) 汞	Cadmium (Cd) 镉	Hexavalent Chromium (Cr(VI)) 六价铬	Polybrominated biphenyls (PBB) 多溴联苯	Polybrominated diphenyl ethers (PBDE) 多溴联苯醚
Assembled printed circuit boards 电路板	X	O	O	O	O	O
Calibration leak 校准漏孔	X	O	O	O	O	O
<p>This table is prepared in accordance with the provisions of SJ/T 11364. 本表是根据 SJ/T 11364 的规定编制的。</p> <p>O: Indicates that said hazardous substance contained in all of the homogeneous materials for this part is below the limit requirement of GB/T 26572. O: 表示该部件所有均质材料中所含的上述有害物质都在 GB/T 26572 的限制要求范围内。</p> <p>X: Indicates that said hazardous substance contained in at least one of the homogeneous materials used for this part is above the limit requirement of GB/T 26572. X: 表示该部件所使用的均质材料中，至少有一种材料所含的上述有害物质超出了 GB/T 26572 的限制要求。</p> <p>(Enterprises may further provide in this box technical explanation for marking “X” based on their actual circumstances.) (企业可以根据实际情况，针对含“X”标识的部件，在此栏中提供更多技术说明。)</p>						

Index

A		F	
Access authorization	25	Factor user gas	47
Access controls	41	Function symbols	15
Access rights	41		
Accessories and spare parts	80	H	
Adjust volume	36	Histories	56
Alarm profile	46		
B		I	
Basic settings	35	I/O module	38
Bus module	40		
C		M	
Calibrate	48	Measure	
External calibration leak	50	Procedure	52
Touchscreen	18	Measurement data	
Calibrating		Delete	55
Check calibration	51	evaluating	54
COOL-Check	75	recording	53
Calibrating the touchscreen	18	Transfer to a USB stick	55
Change calibration leak	74	Menu path	82
Connecting a PC	33		
Connecting the sniffer line	27	N	
COOL-Check		Name user gas	47
change	74		
Lifetime	75	P	
Creating screenshots	43, 53	Parameter	
Cross sensitivity	12	List	57
		Load	43
		Save	43
		PIN assign	42
D		R	
Declaration of Contamination	78, 79	Replacing the sniffer tip	29
Dimensions	21	Restore factory settings	59
		Return	78
		RoHS	85
E			
Error messages	63		
Exchanging the sniffer line	28		
Extension hose	31		

S

Scope of delivery	11
Setting setpoints	45
Settings for the measurements	45
SMART sniffer line	46
User-defined gas	47
Sniffer handle	20
Sniffer line PLUS	12
Storage	11

T

Technical data	21
Touchscreen	15

U

Updating the software	59
USB stick recording	53
Using a USB stick	32
Using calibration leaks	32

W

Water conservation sniffer probe	30
----------------------------------	----



Due to our continuing program of product improvements, specifications are subject to change without notice.
The trademarks mentioned in this document are held by the companies that produce them.