

# Bayard-Alpert Pirani Gauge

Dual Filament Bayard-Alpert Pirani Gauge  
With Fieldbus Interface

BPG402-SD, BPG402-SE, BPG402-SP

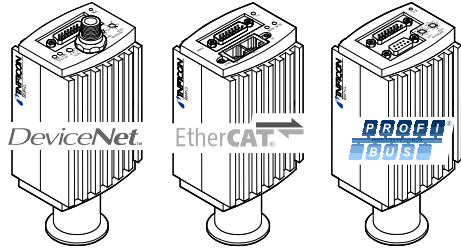

Instruction Sheet

tima47e1-c (2019-01)

**About this document**

This document is a supplement to the standard Instruction Sheet enclosed with the BPG402-Sx (→ [1]). It should be used together with the standard Instruction Sheet.

The symbol (→ [XY]) refers to documents and files listed under "Further Information".

### Product Identification

In all communications with INFICON, please specify the information on the product nameplate. For convenient reference copy that information into the space provided below.

INFICON AG, LI-9496 Balzers

Model: \_\_\_\_\_

PN: \_\_\_\_\_

SN: \_\_\_\_\_

V \_\_\_\_\_ W \_\_\_\_\_

### Validity

This document applies to products with the following part numbers:

BPG402-SD (DeviceNet, 2 switching functions):

- 353-576 (DN 25 ISO-KF)
- 353-577 (DN 40 CF-R)

BPG402-SP (Profibus, 2 switching functions):

- 353-574 (DN 25 ISO-KF)
- 353-575 (DN 40 CF-R)

BPG402-SE (EtherCAT, 2 switching functions):

- Latest EtherCAT version (ETG.5003.2080 S (R) V1.3.0)
- 353-596 (DN 25 ISO-KF)
- 353-597 (DN 40 CF-R)

- Old EtherCAT version (ETG.5003.2080 S (R) V1.0.0)
- 353-590 (DN 25 ISO-KF)
- 353-591 (DN 40 CF-R)

The part number (PN) can be taken from the product nameplate.

If not indicated otherwise in the legends, the illustrations in this document correspond to the vacuum connection DN 25 ISO-KF. They apply to other vacuum connections by analogy.

We reserve the right to make technical changes without prior notice.

All dimensions in mm.

### Intended Use

The BPG402-SD, BPG402-SE and BPG402-SP gauges have been designed for vacuum measurement of gases and gas mixtures in a pressure range of  $5 \times 10^{-10}$  ... 1000 mbar.

### Safety

#### Symbols Used

**DANGER**

Information on preventing any kind of physical injury.

**Caution**

Information on correct handling or use. Disregard can lead to malfunctions or minor equipment damage.

### Personnel Qualifications

**Skilled personnel**

All work described in this document may only be carried out by persons who have suitable technical training and the necessary experience or who have been instructed by the end-user of the product.

### General Safety Instructions

All safety instructions given in [1] and [2] apply to the sensor types described in this document, too.

### Liability and Warranty

INFICON assumes no liability and the warranty becomes null and void if the end-user or third parties

- disregard the information in this document
- use the product in a non-conforming manner
- make any kind of changes (modifications, alterations etc.) to the product
- use the product with accessories not listed in the product documentation.

The end-user assumes the responsibility in conjunction with the process media used.

Gauge failures due to contamination or wear and tear, as well as expendable parts (e.g. filament), are not covered by the warranty.

## BPG402-SD

### General Information

The BPG402-SD gauge has a fieldbus interface that conforms to the DeviceNet standard (→ [10]).

Via this interface, the following and further data are exchanged in the standardized DeviceNet Protocol (→ [3], [10]):

- Pressure reading
- Pressure unit (mbar, Torr, Pa)
- Degas function
- Status and error messages

Two adjustable switching functions are integrated in the gauge. The corresponding relay contacts are available at the sensor cable connector.

The basic sensor and sensor electronics of the BPG402-SD type are the same as in the standard BPG402-S (→ [1], [2]).

### Technical Data

General technical data of the sensor and sensor electronics → [1], [2].

### Fieldbus Interface

Fieldbus name	DeviceNet
Standard applied	→ [10]
Communication protocol, data format	→ [3], [10]
Interface, physical	CAN bus

DeviceNet Parameters	
Data rate (adjustable via "RATE" switch)	125 kBaud 250 kBaud 500 kBaud "P" (programmable) 125 kBaud, 250 kBaud, 500 kBaud via DeviceNet, → [3]
Node address (MAC ID) (adjustable via "ADDRESS, MSD, LSD" switches)	0 ... 63 <sub>dec</sub> "P" (programmable) 0 ... 63 via DeviceNet (→ [3])

DeviceNet connector	Micro-Style, 5-pin, male
Cable	Shielded special DeviceNet cable, 5 conductors (→ [8], [10])
Cable length, system wiring	According to DeviceNet specifications (→ [8], [10])

### Supply Voltages

The power consumption of the BPG402-SD is higher than that of the standard BPG402-S (→ [1], [2]).	
Supply voltage at the sensor connector, pin 8	+24 V (dc) (+20 ... +28 V)
Power consumption	≤18 W

DeviceNet operation requires an additional, separate power supply.

**DANGER**

The gauge may only be connected to power supplies, instruments or control devices that conform to the requirements of a grounded protective extra-low voltage (PELV). The connection to the gauge has to be fused.

Supply voltage at the DeviceNet connector, pin 2	+24 V (dc) (+11 ... +25 (dc))
Power consumption	≤2 W
The gauge is protected from reversed polarity of the supply voltage.	

### Sensor Cable Connection

For reasons of compatibility, the expression "sensor cable" is used in this document, although the pressure reading of the SD-type gauge is normally transmitted via the DeviceNet interface.

Connector	D-sub, 15-pin, male
Cable	max. 12 conductors, shielded
Cable length, (conductor cross section per conductor)	≤35 m (0.25 mm <sup>2</sup> ) ≤50 m (0.34 mm <sup>2</sup> ) ≤100 m (1.0 mm <sup>2</sup> )
Switching functions	2 Setpoints adjustable via potentiometers (Setpoints A and B), one floating, normally open contact per setpoint
Relay contact rating	
Voltage	≤30 V (dc)
Current	≤0.5 A
Gauge identification	42 kΩ between pin 10 and pin 5 (sensor cable)
Grounding principle	→ "Power Connection"

### Dimensions [mm]

Housing and vacuum connection → [1], [2], gauges with DeviceNet interface are longer as illustrated below:

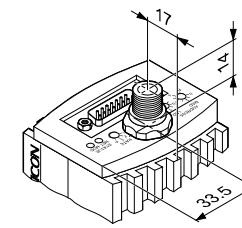

Weight	353-576	≈490 g
	353-577	≈750 g

### Power Connection

#### Sensor Cable Connection

Make sure the vacuum connection is properly made (→ [1], [2], "Vacuum Connection").

If no sensor cable is available, make one according to the diagram.

(Valid for BPG402-SD, BPG402-SE and BPG402-SP)

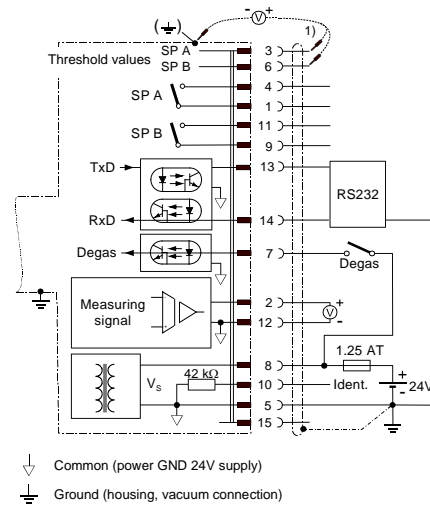

Common (power GND 24V supply)  
Ground (housing, vacuum connection)

9 1  
15 8  
D-Sub, 15 pins, female, soldering side

#### Electrical Connection

Pin 1	Relay switching function A, common contact
Pin 2	Measuring signal output 0 ... +10 V
Pin 3	Threshold (setpoint) A <sup>1)</sup> 0 ... +10 V
Pin 4	Relay switching function A, NO contact
Pin 5	Supply common 0 V
Pin 6	Threshold (setpoint) B <sup>1)</sup> 0 ... +10 V
Pin 7	Degas, active high 0 V/+24 V
Pin 8	Supply (V <sub>s</sub> ) +24 V
Pin 9	Relay switching function B, common contact
Pin 10	Gauge identification
Pin 11	Relay switching function B, NO contact
Pin 12	Measuring signal common
Pin 13	RS232, Tx
Pin 14	RS232, Rx
Pin 15	Do not connect

<sup>1)</sup> Do not connect pin 3 and pin 6 for normal operation of the gauge. These pins are reserved for adjustment of the setpoint potentiometers (→ "Setting the Switching Functions").

Connect the sensor cable to the gauge and secure it using the lock screws

### DeviceNet Cable Connection

If no DeviceNet cable is available, make one according to the following indications:

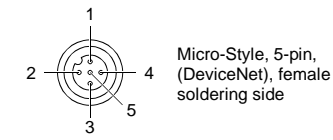

Pin 1	Drain	
Pin 2	Supply (DeviceNet interface only)	+24 V (dc)
Pin 3	Supply common (DeviceNet interface only)	GND
Pin 4	CAN_H	
Pin 5	CAN_L	

Connect the DeviceNet cable to the gauge and lock the cable connector.

### Operation

**Caution**

Data transmission errors

If the gauge is operated via an RS232 interface and the DeviceNet at the same time, data transmission errors may occur.

The gauge must not be operated via an RS232 interface and the DeviceNet at the same time.

### Operating Software

Before the gauge is put into operation, it has to be configured for the DeviceNet. A configuration tool and the device specific EDS file (Electronic Data Sheet) are required for this purpose. This software can be downloaded via internet (→ [7]).

### Node Address Setting

Set the node address (0 ... 63<sub>dec</sub>) via the "ADDRESS" "MSD" and "LSD" switches. The node address is polled by the firmware when the gauge is switched on. If the setting deviates from the stored value, the new value is taken over into the NVRAM. If a setting higher than 63 is made, the previous node address setting remains valid. Default address setting is 63<sub>dec</sub>. If the MSD switch is in the "P" position, the node address is programmable via the DeviceNet (→ [3]).

### Data Rate Setting

By means of the "RATE" switch, the data rate can be set to 125 ("1"), 250 ("2") or 500 kBaud ("5"). Default data rate setting is 500 kBaud. If the switch is in any of the "P" positions, the data rate is programmable via the DeviceNet (→ [3]).

The admissible data rate depends on several factors (system parameters, cable lengths etc.) (→ [10]).

### Adjusting the Gauge

→ Adjustment and settings.

### Adjusting the Switching Functions

→ Adjustment and settings.

### Status Lights



### "STATUS MOD" (gauge status):

Light status	Meaning
Off	No supply
Flashing red/green	Selftest
Green	Normal operation
Red	Non recoverable error

### "STATUS NET" (network status):

Light status	Meaning
Off	Gauge not online: – Selftest not yet concluded – No supply, → "STATUS MOD" light
Flashing green	Gauge online but no connection: – Selftest concluded, but no connection to other nodes established – Gauge not assigned to any master
Green	Gauge online; necessary connections established
Flashing red	One or several input/output connections in "timed out" status
Red	Communication error. The gauge has detected an error that impedes communication via the network (e.g. two identical node addresses (MAC ID) or "Bus-off")

## BPG402-SE

### General Information

The BPG402-SE gauge has a fieldbus interface that conforms to the EtherCAT Technology Group (ETG) and to the EtherCAT Semiconductor Device Profile (→ [12], [13], [14], [15]).

Via this interface, the following and further data are exchanged in the standardized EtherCAT Protocol (→ [1], [2]):

- Pressure reading
- Pressure unit (mbar, Torr, Pa)
- Degas function
- Status and error messages

Two adjustable switching functions are integrated in the gauge. The corresponding relay contacts are available at the sensor cable connector.

The basic sensor and sensor electronics of the BPG402-SE type are the same as in the standard BPG402-S (→ [1], [2]).

### Technical Data

General technical data of the sensor and sensor electronics → [1], [2].

### Fieldbus Interface

Fieldbus name	EtherCAT
Standard applied, data format, communication protocol	→ [12], [13] 353-590, 353-591 → [14], [15] 353-596, 353-597
Data rate	100 Mbps
Node address	explicit device identification
Physical layer	100Base-Tx (IEEE 802.3)
EtherCAT connector	2xRJ45, 8-pin (socket) <IN>: EtherCAT input <OUT>: EtherCAT output
Cable	shielded, 8-pin special Ethernet Patch cable (quality CAT5e or higher)
Cable length	≤100 m



### Supply Voltages

 The power consumption of the BPG402-SE is higher than that of the standard BPG402-S.

Supply voltage at sensor cable connector, pin 8	+24 V (dc) (+20 ... +28 V)
Power consumption	≤21 W

### Sensor Cable Connection

→ "Technical Data, Sensor Cable Connection" of the gauge BPG402-SD (identical).

### Dimensions

Housing and vacuum connection → [1], [2]

Weight		
353-590, 353-596	≈490 g	
353-591, 353-597	≈750 g	

### Power Connection

Make sure the vacuum connection is properly made (→ [1], [2], "Vacuum Connection").

### Sensor Cable Connection

- If no sensor cable is available, make one according to the diagram shown in the BPG402-SD section (identical).
- Connect the sensor cable to the gauge and secure the sensor cable connector using the lock screws.

### EtherCAT Cable Connection

If no Ethernet cables are available, make two according to the following indications:

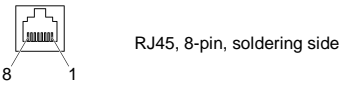

Pin 1	TD+	Transmission Data +
Pin 2	TD-	Transmission Data -
Pin 3	RD+	Receive Data +
Pin 4	not used	
Pin 5	not used	
Pin 6	RD-	Receive Data -
Pin 7	not used	
Pin 8	not used	

Connect the Ethernet cables to the gauge: From the previous device the cable connected to the OUT port has to be connected to the BPG402-SE <IN> port. And the cable from the BPG402-SE <OUT> port has to be connected to the next device's <IN> port.

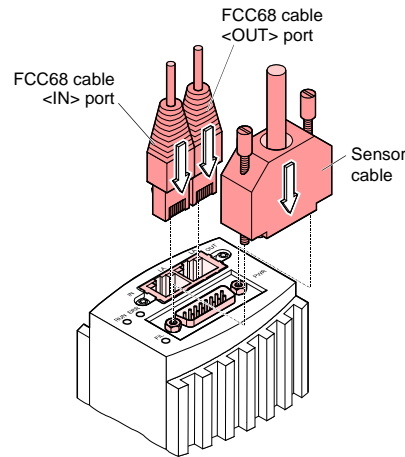

### Operation

 **Caution**  
Data transmission errors  
If the gauge is operated via an RS232 interface and the EtherCAT at the same time, data transmission errors may occur.  
The gauge must not be operated via an RS232 interface and the EtherCAT at the same time.

### Operating Software

For operating the gauge via EtherCAT, prior installation of the device specific ESI file is required on the bus master side. This file can be downloaded from our website.

### Explicit Device Address Setting

During device initialization, the device address switches are read by the device firmware. This device address is reported to the master as Explicit Device Identification.

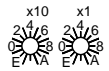

The explicit device address is set in hexadecimal form (00 ... FF<sub>hex</sub>) via the <x10> and <x1> switches.

### Adjusting the Gauge

→ Adjustment and settings.

### Adjusting the Switching Functions

→ "Adjustment and settings".

## BPG402-SP

### General Information

The BPG402-SP gauge has a fieldbus interface that conforms to the Profibus DPV1 standard (→ [4], [11]).  
Via this interface, the following and further data are exchanged in the standardized Profibus protocol (→ [1], [2]):

- Pressure reading
- Pressure unit (mbar, Torr, Pa)
- Degas function
- Status and error messages

Two adjustable switching functions are integrated in the gauge. The corresponding relay contacts are available at the sensor cable connector.

The basic sensor and sensor electronics of the BPG402-SP type are the same as in the standard BPG402-S (→ [1], [2]).

### Technical Data BPG402-SP

 General technical data of the sensor and sensor electronics → [1], [2].

### Fieldbus Interface

Fieldbus name	Profibus
Standard applied	→ [11]
Communication protocol, data format	→ [6], [11]
Interface, physical	RS485

Profibus Parameters	
Data rate	≤12 Mbaud (→ [6], [11])
Node address	00 ... 7D <sub>hex</sub> (0 ... 125 <sub>dec</sub> )

Profibus connection	
Cable	D-Sub, 9-pin, female Shielded special Profibus cable (→ [9], [11])
Cable length, system wiring	According to Profibus specifications (→ [9], [11])

### Supply Voltages

 The power consumption of the BPG402-SP is higher than that of the standard BPG402-S.

Supply voltage at sensor cable connector, pin 8	+24 V (dc) (+20 ... +28 V)
Power consumption	≤20 W

### Sensor Cable Connection

→ "Technical Data, Sensor Cable Connection" of the gauge BPG402-SD (identical).

### Dimensions

Housing and vacuum connection → [1], [2]

Weight		
353-574	≈490 g	
353-575	≈750 g	

### Power Connection

Make sure the vacuum connection is properly made (→ [1], [2], "Vacuum Connection").

### Sensor Cable Connection

- If no sensor cable is available, make one according to the diagram shown in the BPG402-SD section (identical).
- Connect the sensor cable to the gauge and secure the sensor cable connector using the lock screws.

### Profibus Cable Connection

If no Profibus cable is available, make one according to the following indications:

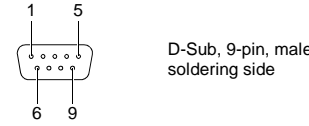

Pin 1	do not connect	
Pin 2	do not connect	
Pin 3	RxD/TxD-P	1)
Pin 4	CNTR-P	1)
Pin 5	DGND	2)
Pin 6	VP	2)
Pin 7	do not connect	
Pin 8	RxD/TxD-N	
Pin 9	do not connect	

- Only to be connected if an *optical link* module is used.
- Only required as line termination for devices at both ends of bus cable (→ [4], [11]).

Connect the Profibus cable to the gauge and secure the Profibus cable connector using the locking screws.

### Operation

 **Caution**  
Data transmission errors  
If the gauge is operated via an RS232 interface and the Profibus at the same time, data transmission errors may occur.  
The gauge must not be operated via an RS232 interface and the Profibus at the same time.

### Operating Software

For operating the gauge via the Profibus network, prior installation of the gauge specific GSD file is required. This software can be downloaded via internet (→ [7]).

### Node Address Setting

The node address (0 ... 125<sub>dec</sub>) is set in hexadecimal form (00 ... 7D<sub>hex</sub>) via the "ADDRESS", "MSD", and "LSD" switches.  
The node address is polled by the firmware when the gauge is switched on. If the setting deviates from the stored value, the new value is taken over into the NVRAM. If a value >125<sub>dec</sub> (>7D<sub>hex</sub>) is entered, the node address setting currently stored in the device remains valid but it can now be defined via Profibus ("Set slave Address", → [4]).  
Default address setting is 5C<sub>hex</sub>.

### Adjusting the Gauge

→ Adjustment and settings.

### Adjusting the Switching Functions

→ "Adjustment and settings".

## Adjustment and Settings

For BPG402-SD, BPG402-SE and BPG402-SP gauges.

### Adjusting the Gauge

The gauge is factory calibrated. If used under different climatic conditions, at extreme temperatures, through aging or contamination and after exchanging the sensor, the characteristic curve can be offset and readjustment can become necessary. Only the Pirani part can be adjusted.

### Adjusting the Gauge at Atmospheric Pressure

At the push of a button the digital value and thus the analog output are adjusted electronically to +10 V at atmospheric pressure.

Adjustment is necessary if

- at atmospheric pressure, the output signal is <+10 V
- the display reads < atmospheric pressure (if the gauge has a display)
- at atmosphere, the digital value of the RS232C interface is < atmospheric pressure
- at atmosphere, the digital value received by the bus controller of the fieldbus gauges (DeviceNet or Profibus) is < atmospheric pressure
- when the vacuum system is vented, the digital value of the RS232C interface reaches its maximum before the measured pressure has reached atmosphere

when the vacuum system is vented, the digital value received by the bus controller of the fieldbus (DeviceNet or Profibus) reaches its maximum before the measured pressure has reached atmosphere.

### Procedure

- Operate gauge for approx. 10 minutes at atmospheric pressure.  
If the gauge was operated before in the Bayard-Alpert range, a cooling-down time of approx. 30 minutes is to be expected (gauge temperature = ambient temperature).
- Press the button with a pin (max. ø1.3 mm) for 1 s.

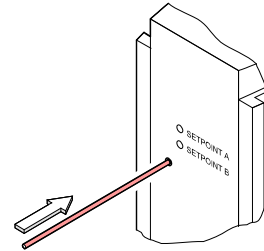

### Zero Point Adjustment

Zero point readjustments are automatically carried out during operation of the gauge, no manual adjustments are required.

### Setting the Switching Functions

The gauges BPG402-SD and BPG402-SP have two independent, manually adjustable switching functions. Each switching function has a floating, normally open relay contact. The relay contacts are accessible at the sensor cable connector (→ "Power Connection"). The threshold values of switching functions A and B can be set within the pressure range 1x10<sup>-9</sup> mbar ... 100 mbar via potentiometers "SETPOINT A" and "SETPOINT B".

For the corresponding threshold voltages U<sub>Threshold</sub>, the following rule applies:

$$U_{Threshold} = 0.75 \times (\log p_{Setpoint} - c) + 7.75$$

Where p pressure  
U Threshold voltage [V]  
c constant (pressure unit dependent)

p	c
[mbar]	0
[Pa]	2
[Torr]	-0.125

Measuring signal (Pressure p)

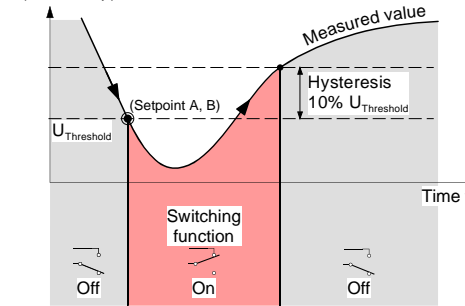

The hysteresis of the switching function is 10% of the threshold setting.

BPG402-SE gauges: The two switching functions can be set via the EtherCAT interface only.

### Procedure

- Put the gauge into operation.
- Connect the + lead of a voltmeter to the threshold measurement point of the selected switching function ("Setpoint A" pin 3, "Setpoint B" pin 6) and its - lead to a ground contact nearby (e.g. grounded locking screw nut of connector or vacuum connection of the gauge).  
 The threshold voltages are referenced to ground (housing, vacuum connection), **not** to pin 5 (common power GND 24 V supply).  
The analog threshold voltage readings on pins 3 and 6 are only a guide line. Full accuracy can be achieved by reading the threshold voltage values via the fieldbus interface (→ [3], [4]).

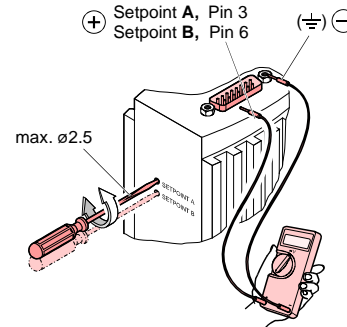

Using a screwdriver (max. ø2.5 mm), set the threshold of the selected switching function (Setpoint A, B) to the desired value U<sub>Threshold</sub>.

 A functional check of the switching functions (On/Off) is only possible via fieldbus interface (→ [3] for BPG402-SD, → [4] for BPG402-SP, → [5] or [6] for BPG402-SE) or by measuring the relay contacts with a continuity checker/ohmmeter (→ "Power Connection", sensor cable connector).

## Further Information

- www.inficon.com  
Instruction Sheet  
Bayard-Alpert Pirani Gauge BPG402-S, BPG402-SD, BPG402-SP  
tira46e1  
INFICON AG, LI-9496 Balzers, Liechtenstein
- www.inficon.com  
Operating Manual  
Bayard-Alpert Pirani Gauge BPG402-S, BPG402-SD, BPG402-SP  
tira46e1  
INFICON AG, LI-9496 Balzers, Liechtenstein
- www.inficon.com  
Communication Protocol  
DeviceNet™ BPG402-SD  
tira46e1  
INFICON AG, LI-9496 Balzers, Liechtenstein
- www.inficon.com  
Communication Protocol  
Profibus BPG402-SP  
tira47e1  
INFICON AG, LI-9496 Balzers, Liechtenstein
- www.inficon.com  
Communication Protocol  
EtherCAT BPG402-SE(ETG.5003.2080 S (R) V1.0.0)  
tira93e1  
INFICON AG, LI-9496 Balzers, Liechtenstein
- www.inficon.com  
Communication Protocol  
EtherCAT BPG402-SE (ETG.5003.2080 S (R) V1.3.0)  
tir53e1 (english)  
INFICON AG, LI-9496 Balzers, Liechtenstein
- www.inficon.com  
("Semiconductor and Vacuum coating processes, Vacuum Gauges")  
Product descriptions and downloads  
INFICON AG, LI-9496 Balzers, Liechtenstein
- www.odva.org  
Open DeviceNet Vendor Association, Inc.  
"DeviceNet™ Specifications"
- www.profibus.com  
Profibus user organisation
- European Standard for DeviceNet EN 50325
- European Standard for Profibus EN 50170
- ETG.5003.1 S (R) V1.0.0: Semiconductor Device Profile – Part 1: Common Device Profile (CDP)
- ETG.5003.2080 S (R) V1.0.0: Semiconductor Device Profile – Part 2080: Specific Device Profile (SDP): Vacuum Pressure Gauge
- ETG.5003.1 S (R) V1.1.0: Semiconductor Device Profile – Part 1: Common Device Profile (CDP)
- ETG.5003.2080 S (R) V1.3.0: Semiconductor Device Profile – Part 2080: Specific Device Profile (SDP): Vacuum Pressure Gauge