

OPERATING MANUAL

linc84en1-04 (1610)

Catalog No.

155 80

155 81

Adjustable Helium Test Leak TL3-5 / TL4-6



Content

1	Technical Data	1-1
2	Supplied Equipment	1-3
3	Operating and Handling	1-4
3.1	First Use or Changing the Type of Gas	1-6
3.2	Changing the Reservoir Cylinder without Changing the Type of Gas	1-10
3.3	Storage when unused	1-13
3.4	Maintenance	1-13
4	Applications	1-14
4.1	Use for Vacuum Leak Detection	1-14
4.2	Use for Overpressure Leak Tests (Sniffer Probe)	1-14
5	Using Search Gases other than Helium	1-17
6	Adjustment of leak rate	1-19
7	Spare Parts	1-24

INFICON-Service

If an appliance is returned to INFICON, indicate whether the appliance is free of substances damaging to health or whether it is contaminated. If it is contaminated also indicate the nature of hazard.

For this please use the form provided in the Annex. INFICON must return any appliance without a declaration of contamination to the sender's address.



Caution

Indicates procedures that must be strictly observed to prevent damage to, or destruction of, the test leak.

The references to diagrams, e.g. (2/5), consist of the Fig. No. and the Item No. in that order.

General Note

The right of alterations in the design and the technical data is reserved. The illustrations are not binding.

1 *Technical Data*

Test Leak	
Leak rate adjustment range TL3-5	$10^{-3} \dots 10^{-5}$ mbar l/s
Leak rate adjustment range TL4-6	$10^{-4} \dots 10^{-6}$ mbar l/s
Nominal leak rate TL3-5	$5 \cdot 10^{-5}$ mbar l/s
Nominal leak rate TL4-6	$5 \cdot 10^{-6}$ mbar l/s
Uncertainty of the nominal leak rate ¹⁾	± 10%
Temperature coefficient	Negligible
Leak type	Capillary
Calibrated for	Helium
Connecting flange	DN 16 ISO-KF
Manometer reading	-1 ... +15 bar (overpressure)
Helium cylinder	
Test gas	Helium 5.0
Purity	99.999 Vol.-%
Bottle capacity	1 l
Filling pressure	12 bar
Filling amount	12 l
Inlet pressure max.	max. 12 bar
Weight	
With gas cylinder:	425 g
Without gas cylinder:	300 g

¹⁾ with manometer reading 0 bar and $p < 1$ mbar at connecting flange.

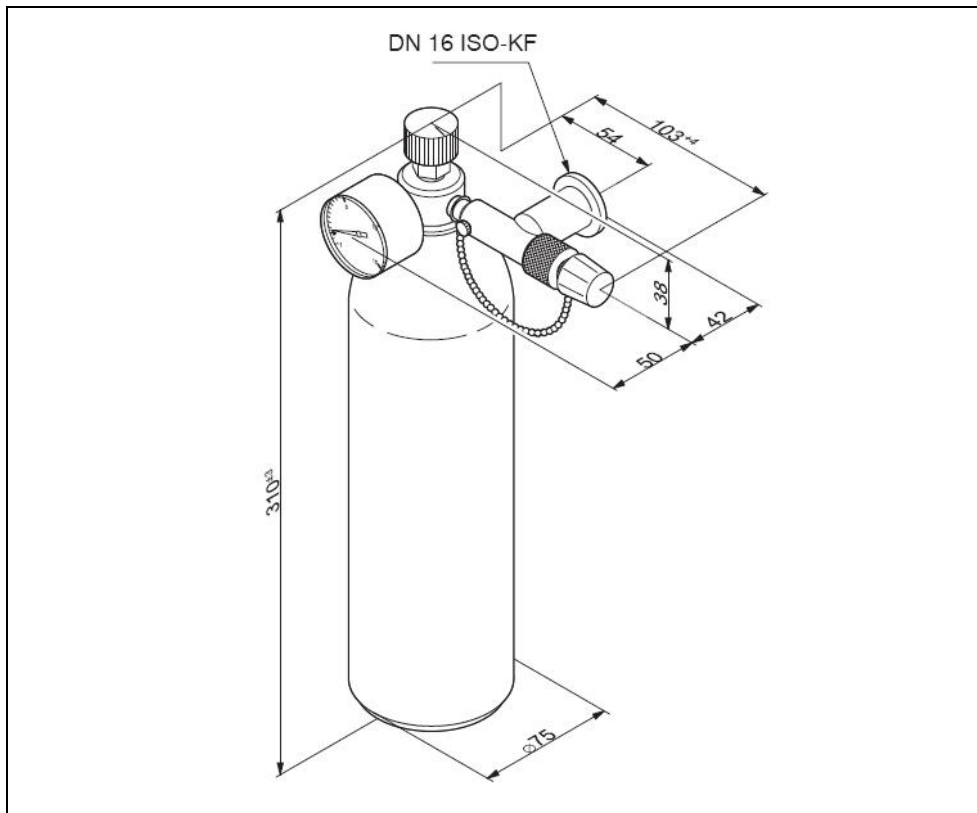

Fig. 1-1 Dimensional drawing (all measures in mm)

2 *Supplied Equipment*

- 1 test leak complete with manometer, gas-reservoir shut-off valve and leak shut-off valve
- 1 helium bottle (HE 5.0; 12 bar; 1 l)
- 1 holder for setting up the helium bottle with test leak
- Installation instructions for the holder

3 *Operating and Handling*

Always unscrew valve for a short time only. The leak outlet area on valve should not be touched, particularly not with your fingers or greasy objects.

Retain the protection cap for the flange and fit it each time the test leak is removed.



Caution

The reservoir cylinder is pressurised.

Protect it against direct sun light, temperatures over 50 °C and damage.

Holder

The holder included is used for safe storage of the test leak. It is installed according to the mounting instructions included, see [Fig. 1-2](#).

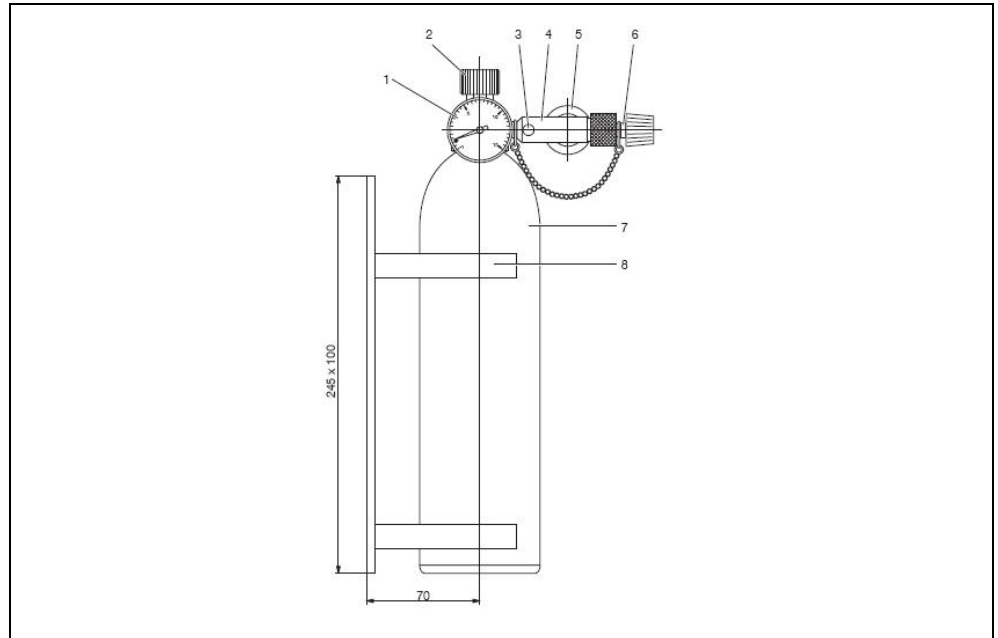

Fig. 1-2 Test leak TL 3-5 / 4-6, complete

Pos.	Description	Pos.	Description
1	overpressure manometer for test gas pressure	5	connecting flange DN 16 ISO-KF
2	test gas supply shut-off valve	6	shut-off valve for leak outlet orifice
3	vent screw	7	test gas bottle
4	body with leak apillary	8	holder

3.1 *First Use or Changing the Type of Gas*

- 1** Close all valves and the vent screw.
- 2** Unscrew old test gas bottle.
- 3** Remove protective cap from new test gas bottle.
- 4** Screw in the new reservoir (hand tight) until to the stop.

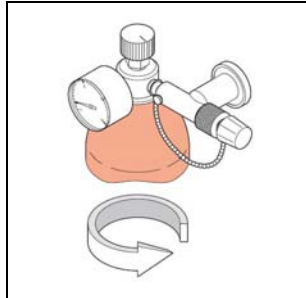

Fig. 1-3

- 5** Open the test gas supply on the reservoir (the knob turns downwards!)

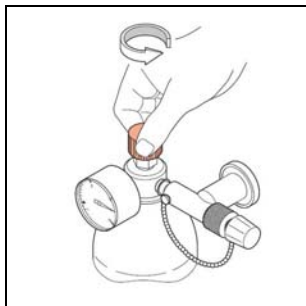

Fig. 1-4

The pressure gauge must now indicate the pressure of the gas bottle.

- 6** Close the blocking valve on the reservoir (the knob turns upwards!).

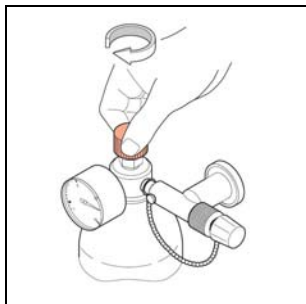

Fig. 1-5

- 7 Open the vent screw so far that the pressure drops to 0 bar (purge).

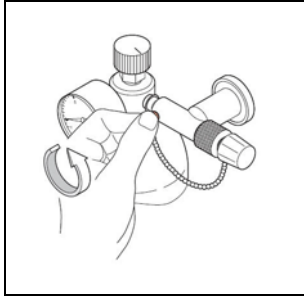

Fig. 1-6

- 8 Close the vent screw.

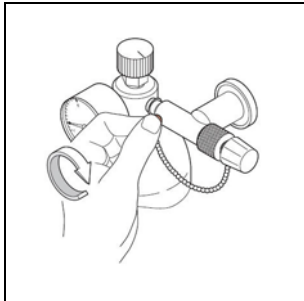

Fig. 1-7

- 9 Open the test gas supply, so that the pressure reaches the pressure of the test gas cylinder.

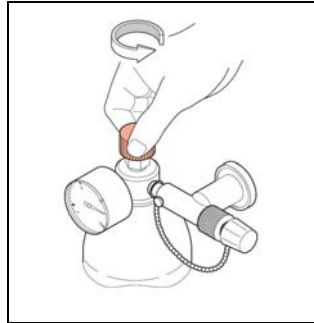

Fig. 1-8

- 10 Close test gas supply.

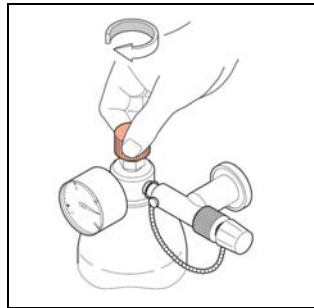

Fig. 1-9

Repeat process steps 6. to 10. twice so as to ensure that the gas reservoir in front of the test leak has been exchanged completely.

The test leak will now be ready. The desired pressure can be adjusted with the venting screw.

3.2 ***Changing the Reservoir Cylinder without Changing the Type of Gas***

- 1** Close all valve. (the knob turns upwards!)
- 2** Unscrew the old test gas bottle.

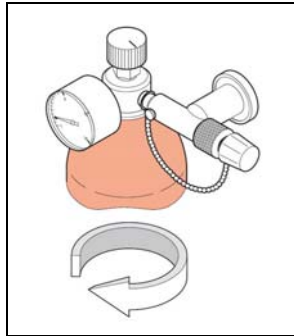

Fig. 1-10

- 3** After removing the protective cap screw on the new test gas bottle.

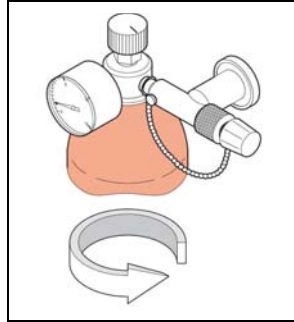

Fig. 1-11

- 4** Open the test gas supply.
The manometer displays now the test gas bottle pressure.

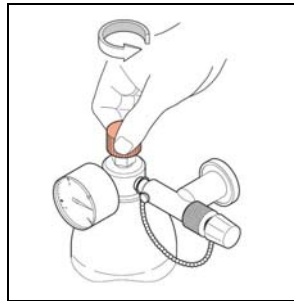

Fig. 1-12

5 Close the test gas supply.

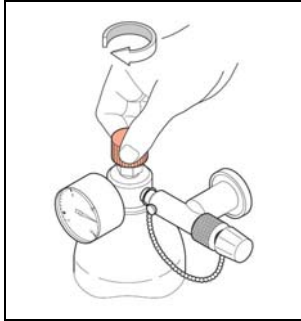

Fig. 1-13

6 Open the vent screw so far, that the pressure drops to the desired pressure.

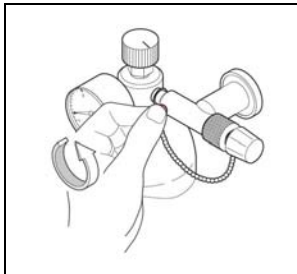

Fig. 1-14

7 Close the vent screw.

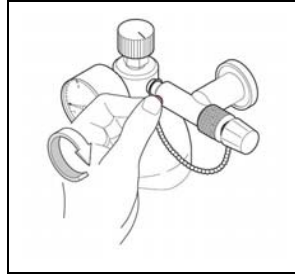

Fig. 1-15

The Helium test leak is now ready for operation.

3.3 Storage when unused

Put the protective cap on the connection flange DN 16 KF and make sure that all valves and the vent screw are closed. Store the Helium test leak in a lying position or standing upright in the holder, protected against impact shock and high temperatures

3.4 Maintenance

It is recommended to retighten the union nut of the valve (Fig. 1-2/2) from time to time at a torque of 2.5 Nm by turning it in clockwise direction (how often this is required depends on how much the test leak is used). Thereafter it must be easily possible to turn the knob with two fingers.

4 Applications

4.1 Use for Vacuum Leak Detection

The test leak TL3-5 / TL4-6 can be fitted by its DN 16 KF flange connection to any leak detector or any vacuum apparatus and can then be used for tuning the mass spectrometer as well as for checking response time and detection sensitivity. To adjust the test leak rate see chapter 6, [Fig. 1-20](#) and [Fig. 1-21](#).

4.2 Use for Overpressure Leak Tests (Sniffer Probe)

The Helium test leak TL3-5 / TL4-6 is set up in holder (see [Fig. 1-1/2](#)). By unscrewing the valve at the swivel nut the Helium test leak TL3-5 / TL4-6 becomes accessible for a sniffer probe tip.

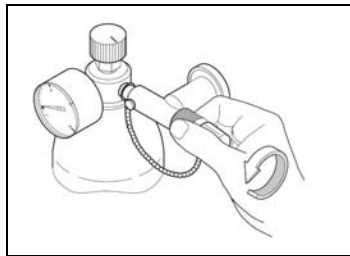

Fig. 1-16

The leak outlet orifice itself is on the face of the sealed-in tubulation which is now visible.

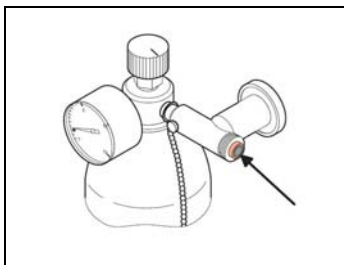

Fig. 1-17



Caution

Clogging of the leak capillary.

The size of the leak outlet orifice can change or get choked due to contamination



Caution

Do not touch the leak outlet orifice with the fingers or with greasy objects.



Caution

When no longer using the test leak anymore always close the valve.

The measured leak rate depends on the distance between sniffer tip and leak, and also on the speed at which the sniffer tip is moved past the leak.

The size of the leak depends on the pressure as indicated on the pressure gauge and can be determined from the leak rate diagrams.

5 Using Search Gases other than Helium

When using test gases other than helium, leak rates can only approximately be determined, the reason being that the 10^{-8} to 10^{-4} mbar·l/s range includes just the transition-flow region between molecular and laminar gas flow. Moreover, the individual flow profile of the respective capillary affects the conversion factor. In the molecular flow region (leak rates $< 1 \cdot 10^{-5}$ mbar l/s) the leak rate q of different gases at otherwise equal conditions depends on the gas type as:

$$\frac{q_x}{q_{\text{He}}} = \sqrt{\frac{M_{\text{He}}}{M_x}}$$

M = relative molecular mass

In the laminar flow region the leak rate depends on the gas type as:

$$\frac{q_x}{q_{\text{He}}} = \frac{\eta_{\text{He}}}{\eta_x}$$

η = dynamic viscosity

Some values of dynamic viscosity η in 10^{-5} Pa•s.

	He	R 134a	Air	Ar	H ₂
η	1,96	1,36	1,82	2,21	0,88
M	4	102	28	40	2

The resulting values must be used according to the predominant type of gas flow, i.e. for leak rates lower than 10^{-5} mbar·l/s mainly molecular flow and for leak rates higher than 10^{-5} mbar·l/s mainly laminar flow can be assumed.

6 *Adjustment of leak rate*

The nominal leak rate was measured during production at a test gas pressure of 1 bar (abs.) vs. a pressure of lower than 1 mbar at the connecting flange and is shown on the label. The adjustment diagrams are valid for nominal leak rate of $5 \cdot 10^{-5}$ mbar l/s \pm 10% for the test leak TL 3-5 and a nominal leak rate of $5 \cdot 10^{-6}$ mbar l/s \pm 10% for the test leak TL 4-6. The leak rate is pressure dependent and can be found in the diagrams Leak Rate/Pressure (see [Fig. 1-18](#) to [Fig. 1-21](#)). Upon request, individual calibration of a single test leak as a function of the search-gas pressure can be made in our factory at cost price.

If you suspect the nominal leak rate has changed after longer use, also recalibration of the test leak can be made in our factory against charge. When demanding higher accuracy we recommend a recalibration once a year.

If a calibration certificate is required, it can be issued by our Cologne factory. Calibration and calibration certificates are available to order against charge.

The test leak rates depend on the adjusted pressure [bar rel], see the following diagrams.

If a significant deviation from the nominal leak rate of $5 \cdot 10^{-5}$ resp. $5 \cdot 10^{-6}$ mbar l/s occurs, a factor can be calculated based on the leak rate diagrams. The nominal leak rate is to be multiplied by this factor.

Calculation of the factor:

$$\text{Factor} = \frac{\text{Leak rate (from diagram)}}{5 \cdot 10^{-5} \text{ resp. } 5 \cdot 10^{-6}}$$

Diagram Leak Rate / Pressure

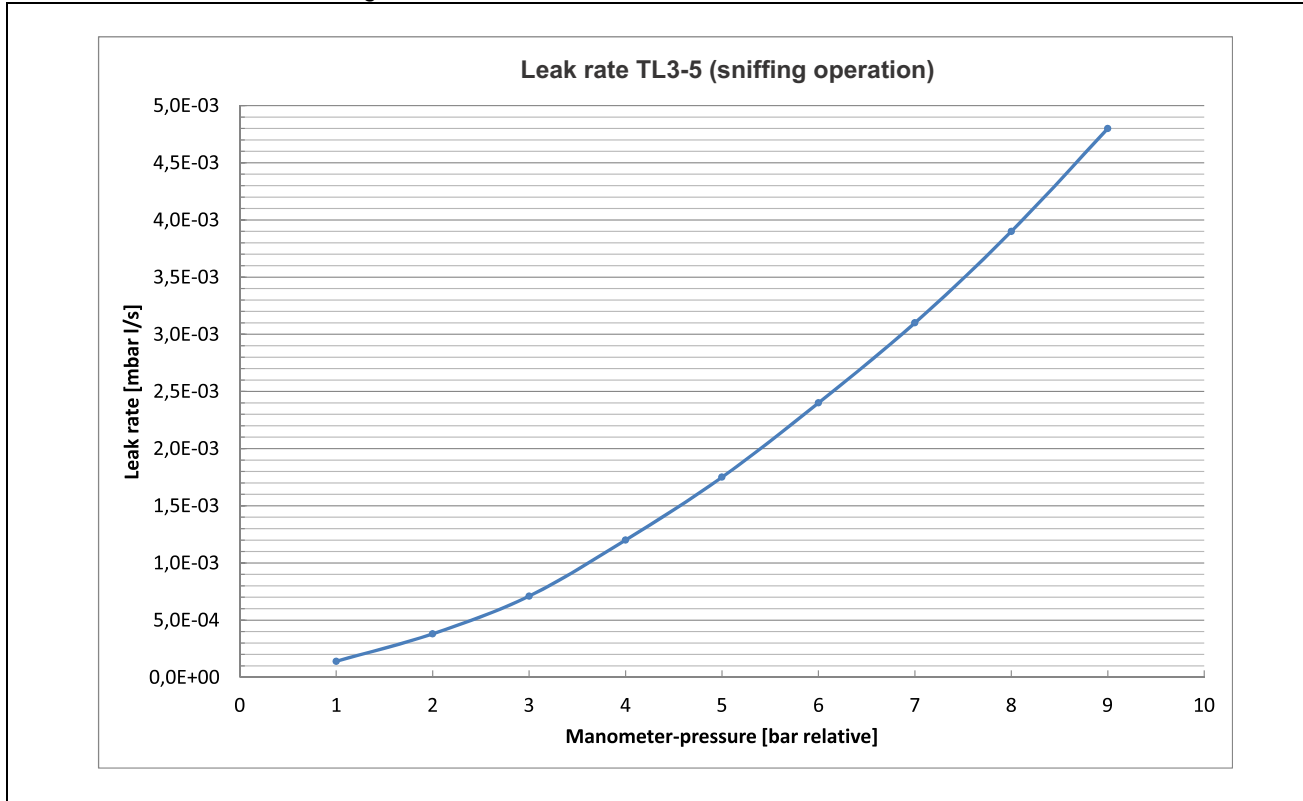

Fig. 1-18 Diagram Test Leak TL3-5

Diagram Leak Rate / Pressure

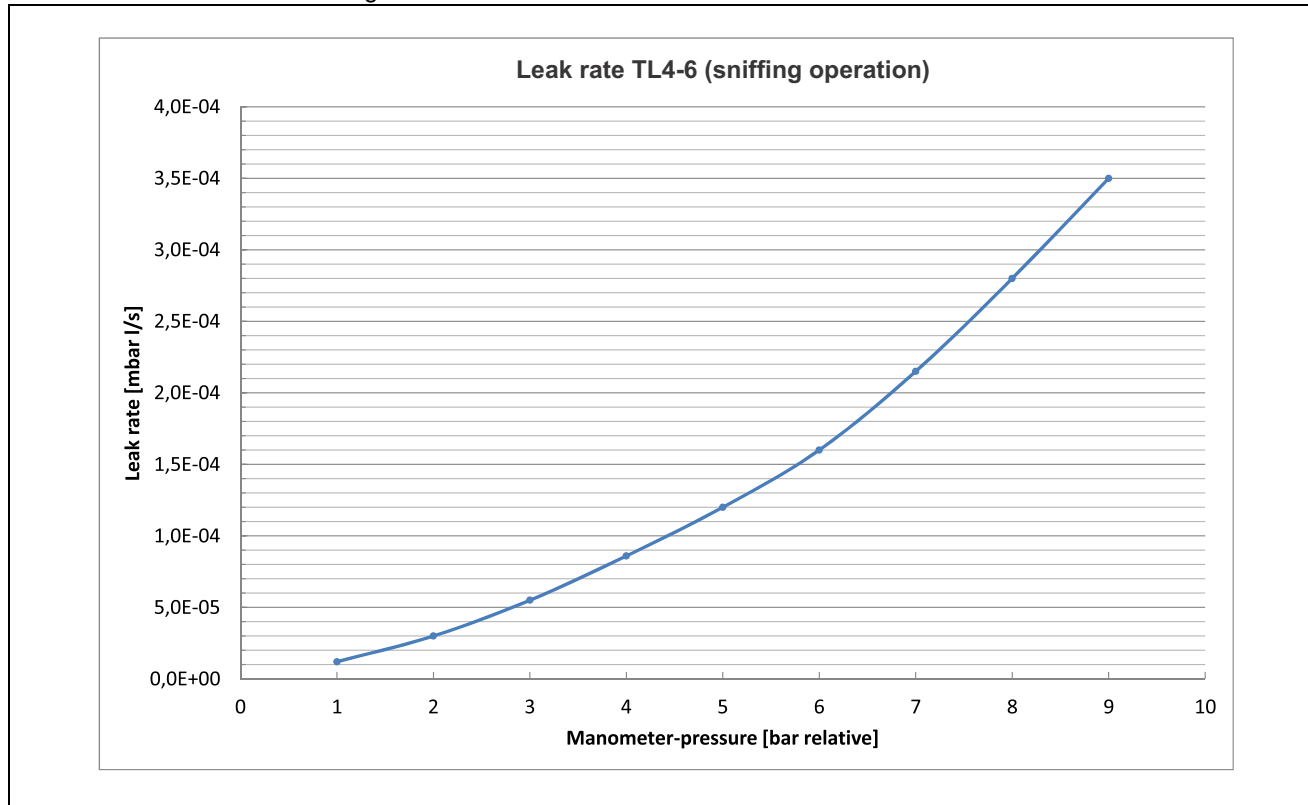

Fig. 1-19 Diagram Test Leak TL4-6

Diagram Leak Rate / Pressure

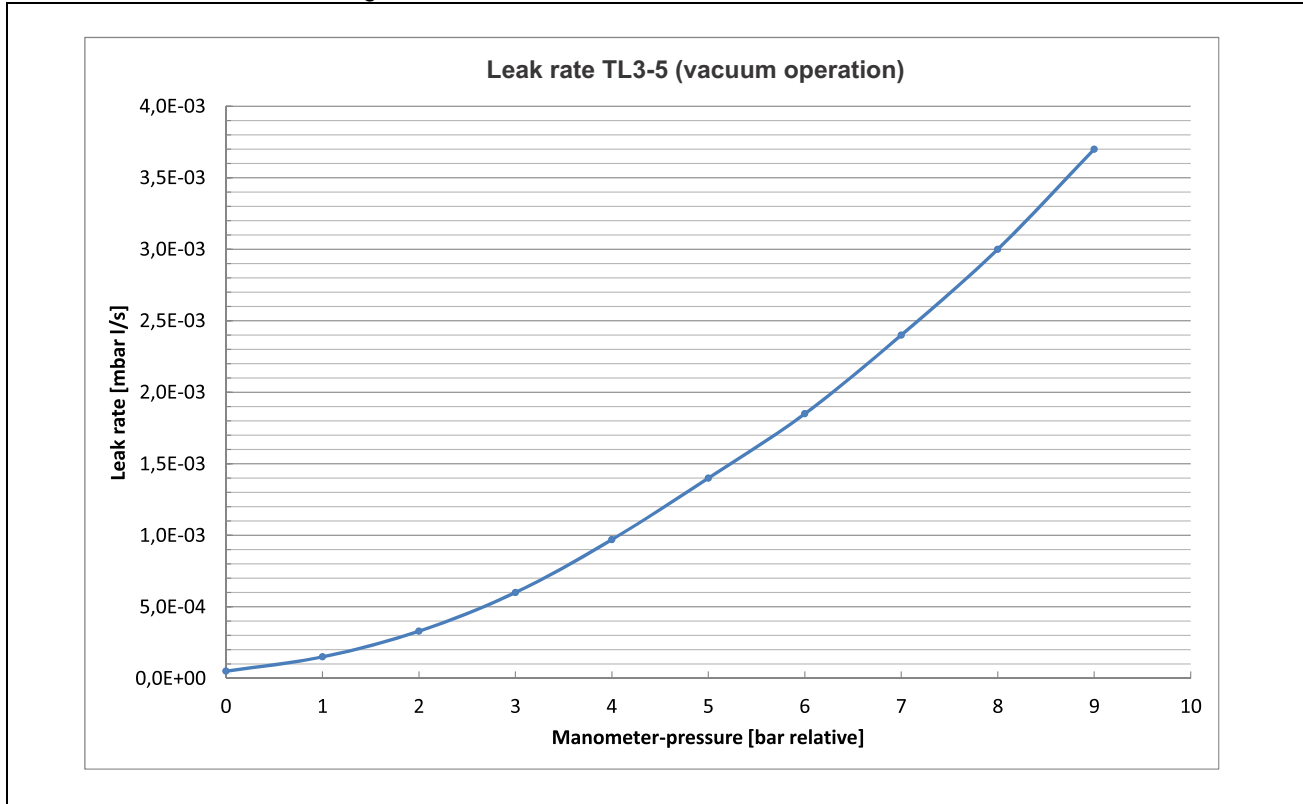

Fig. 1-20 Diagram Test Leak TL3-5

Diagram Leak Rate / Pressure

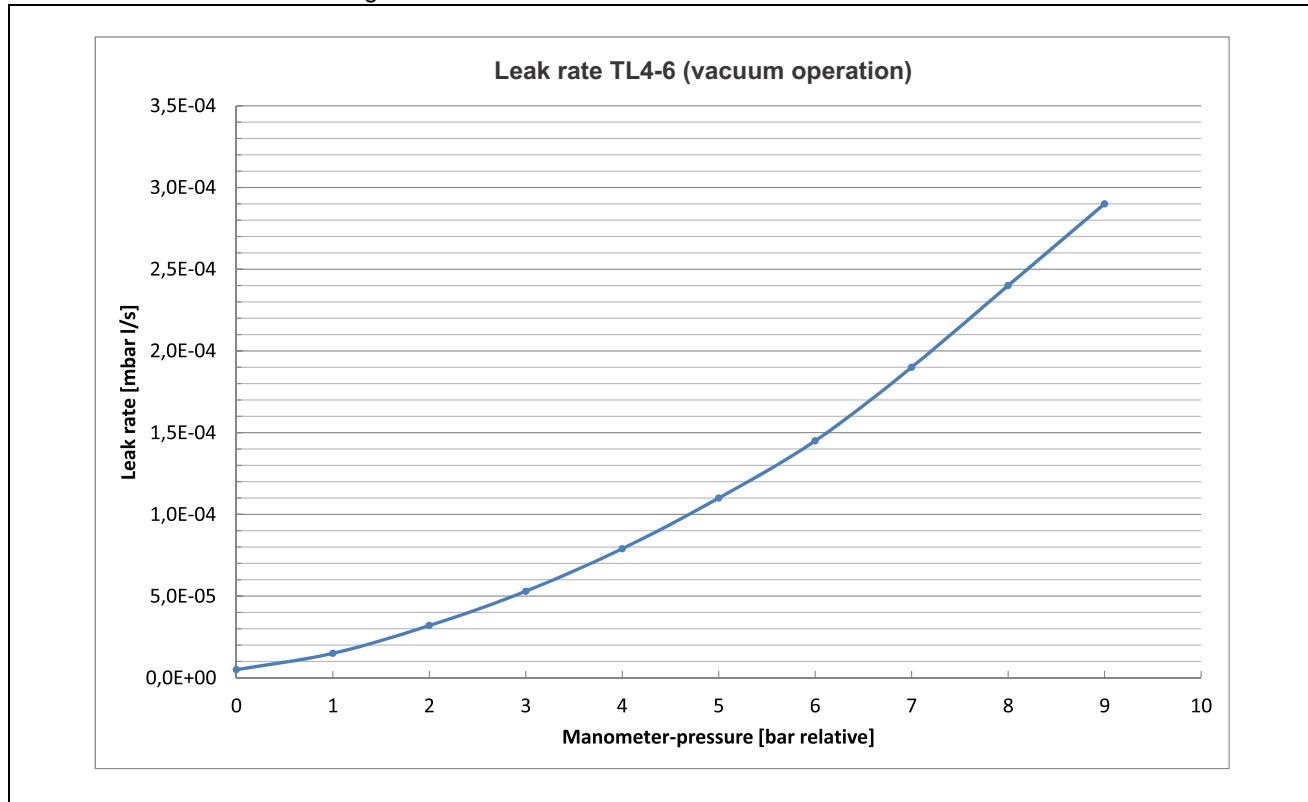

Fig. 1-21 Diagram Test Leak TL4-6

7 *Spare Parts*

Item	Ref. No.
Helium (12 bar, 1 l)	200 003 342



INFICON GmbH, Bonner Strasse 498, D-50968 Cologne, Germany
Phone: +49 (0)221 347-40 Fax: +49 (0)221 347-41429 E-mail: leakdetection@inficon.com

UNITED STATES TAIWAN JAPAN KOREA SINGAPORE GERMANY FRANCE UNITED KINGDOM HONG KONG
Visit our website for contact information and other sales offices worldwide. www.inficon.com

Dokument: linc84en1-04 (1610)