

EtherCAT®

for Bayard-Alpert Pirani Capacitance Diaphragm Gauge

BCG450-SE

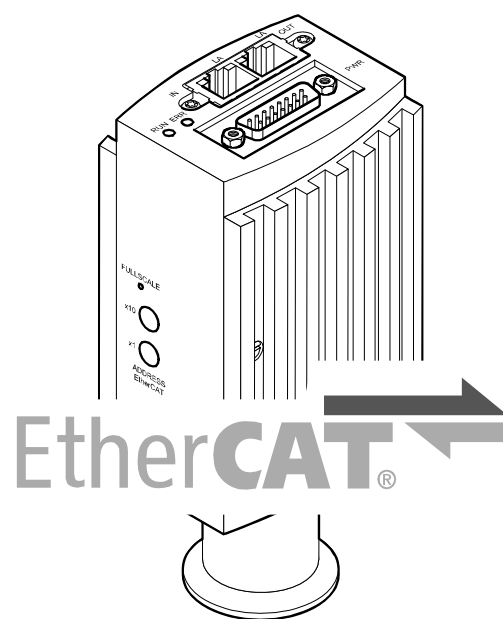

General Information

Caution

Caution: data transmission errors

Any attempt to simultaneously operate the gauge via the RS232C Serial Interface and EtherCAT interface or the diagnostic port may result in incorrect data and data transmission errors.

Therefore, it is inadmissible to simultaneously operate the gauge via the RS232C Serial Interface and EtherCAT interface, or the diagnostic port.

Intended Use

This Communication Protocol contains instructions for operating EtherCAT interfaces (slaves) together with a master.



For safety information, specifications and operation instructions of the vacuum gauges refer to the appropriate documents (→ [1], [2], [3]).

EtherCAT-Interface

The following description of the EtherCAT® interface is compliant to the EtherCAT specification of the EtherCAT Technology Group (ETG) and to the "EtherCAT® Semiconductor Device Profile".

This manual describes the functionality of a EtherCAT slave and supports

- ETG.5003.1 S (R) V1.0.0 : Part 1 Common Device Profile (CDP) (→ [12]) and
- ETG.5003.2080 S (R) V1.0.0 : Part 2080: Specific Device Profile (SDP): Vacuum Pressure Gauge (→ [13]).

We reserve the right to make technical changes without prior notice.

Product Identification

In all communications with INFICON, please specify the information on the product nameplate. For convenient reference copy that information into the space provided below.

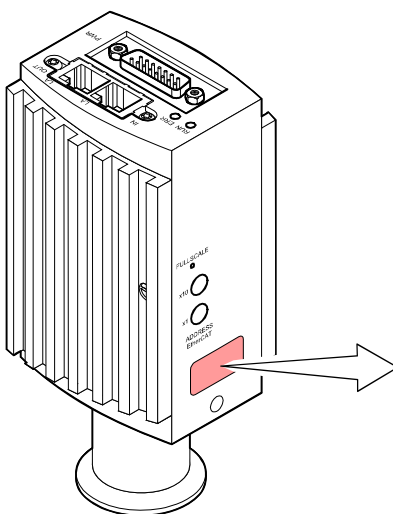

INFICON AG, LI-9496 Balzers	
Model:	-----
PN:	-----
SN:	-----
----- V	----- W

Validity

This document applies to products with part numbers

353-592 (BCG450-SE with EtherCAT, vacuum connection DN 25 ISO-KF)

353-593 (BCG450-SE with EtherCAT, vacuum connection DN 40 CF-R)

This manual is based on firmware version 1.2.0.0.

If your unit does not work as described in this document, please check that it is equipped with the above firmware version (→  12 Index: 0x100A Subindex: 0x00).

The part number (PN) can be taken from the product nameplate.

If not indicated otherwise in the legends, the illustrations in this document correspond to the gauge BCG450-SE with vacuum connection DN 25 ISO-KF. They apply to gauges with other vacuum connections by analogy.

We reserve the right to make technical changes without prior notice.

Trademark

EtherCAT[®] Beckhoff Automation GmbH, Deutschland

Contents

General Information	2
Intended Use	2
EtherCAT–Interface	2
Product Identification	2
Validity	3
Trademark	3
Contents	4
1 Technical Data	6
2 Interface Connection	7
3 Operation	8
3.1 Introduction	8
3.2 Front View	8
3.3 Indicators and Switches	9
3.3.1 <RUN> LED	9
3.3.2 <ERR> LED	9
3.3.3 <LA> LED (<IN> Port)	9
3.3.4 <LA> LED (<OUT> Port)	9
3.3.5 Device Address Switch	10
4 Object Structure	11
4.1 Object Dictionary structure	11
4.2 Communication Profile Objects (0x1000...0x1FFF)	12
4.2.1 Process Data Objects (PDO's)	12
4.3 Manufacturer-specific Profile Objects (0x2000...0x5FFF)	14
4.3.1 Configuration Capacitance Diaphragm Module 1	14
4.3.2 Configuration Piezo Module 2	14
4.3.3 Configuration Heat Transfer Module 3	14
4.3.4 Configuration Hot Cathode Ion Module 4	14
4.4 Input Area (0x6000...0x6FFF)	15
4.4.1 Input Common Capacitance Diaphragm	15
4.4.2 Input Capacitance Diaphragm	15
4.4.3 Input Common Piezo	15
4.4.4 Input Piezo	16
4.4.5 Input Common Heat Transfer	16
4.4.6 Input Heat Transfer	17
4.4.7 Input Common Hot Cathode Ion	17
4.4.8 Input Hot Cathode Ion	17
4.4.9 Input Trip Point 1	18
4.5 Configuration Area (0x8000...0x8FFF)	19
4.5.1 Configuration Hot Cathode Ion	19
4.5.2 Configuration Trip Point 1	19
4.5.3 Configuration Trip Point 2	22
4.6 Information Area (0x9000...0x9FFF)	23
4.6.1 Information Capacitance Diaphragm	24
4.6.2 Information Common Piezo	25
4.6.3 Information Piezo	25
4.6.4 Information Common Heat Transfer	25
4.6.5 Information Heat Transfer	26
4.6.6 Information Common Hot Cathode Ion	26
4.6.7 Information Hot Cathode Ion	27
4.6.8 Information Trip Point 1/2	27
4.7 Device Area (0xF000...0xAFFF)	27
4.7.1 Semiconductor Device Profile	27
4.7.2 Module Profile List	27
4.7.3 Exceptions	28
4.7.4 Active Exception Status	28
4.7.5 Active Device Warning Details	28
4.7.6 Active Device Error Details	29
4.7.7 Latched Device Warning Details	30
4.7.8 Latched Device Error Details	31
4.7.9 Device Warning Mask	31
4.7.10 Device Error Mask	32
4.7.11 Combination Gauge	32
4.7.12 Trip Point Output All	33
4.7.13 Input Latch Local Timestamp	33

4.7.14	Configure Device	33
4.7.15	Information Device	35
4.7.16	Command Full Scale Adjust	36
4.7.17	Command Degas ON / OFF	37
4.7.18	Command Emission ON / OFF	37
4.7.19	Device Reset Command	38
4.7.20	Exception Reset Command	38
4.7.21	Store Parameters Command	39
Appendix		40
A:	Literature	40

For cross-references to other documents, the symbol (→  [XY]) is used.

1 Technical Data



Further technical data → [1], [2], [3].

EtherCAT interface

Communication protocol	protocol specialized for EtherCAT
Communication standards	ETG.5003.1: Part 1 Common Device Profile (CDP) ETG.5003.2080: Part 2080 Specific Device Profile (SDP): Vacuum Pressure Gauge
Data rate	100 Mbps
Node address	Explicit Device Identification
Physical layer	100BASE-Tx (IEEE 802.3)
Digital functions	read pressure, select units (Torr, mbar, Pa) emission control, degas function monitor gauge status, filament status safe state allows definition of behavior in case of error
Analog functions	0 ... 10 V analog output pressure indication two setpoint relays A + B
Setpoint relays	2
Range	1×10^{-9} ... 100 mbar
Relay contact	n.o. potential free
Hysteresis	10 % of reading
Contact rating	≤ 30 V / ≤ 0.5 A (dc)
EtherCAT connector	2 × RJ45, 8-pin (socket) <IN>: EtherCAT input <OUT>: EtherCAT output
Cable	shielded, special Ethernet Patch Cable (CAT5e quality or higher)
Cable length	≤ 100 m
Process data	Fixed PDO mapping and configurable PDO mapping
Mailbox (CoE)	SDO requests, responses and information

Dimensions [mm]

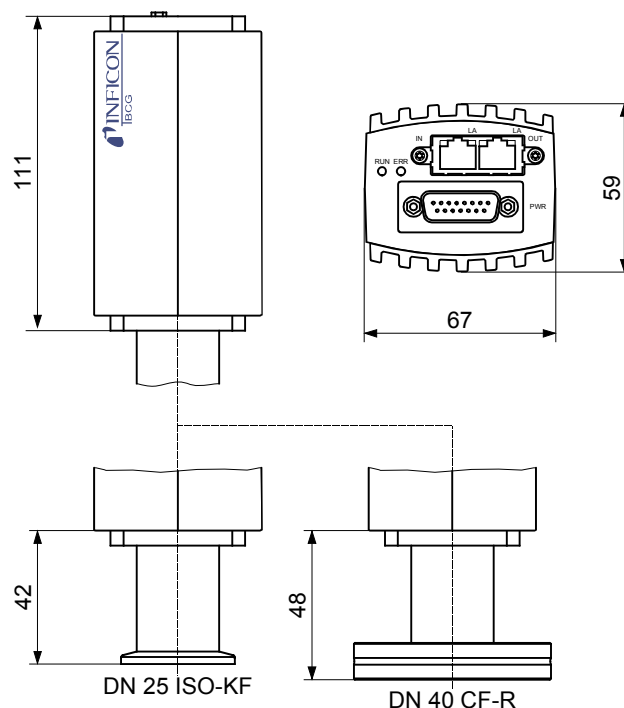

2 Interface Connection

Making an EtherCAT interface cable

For operating the BCG450-SE gauge via EtherCAT, two interface cables conforming to the EtherCAT standard are required.

If no such cables are available, make two according to the following indications.

Cable type

Ethernet Patch Cable (CAT5e quality) with FCC68 connector.

Procedure

1 Pin assignment:

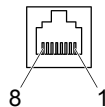

FCC68, 8-pin, male, soldering side

Pin	Signal	Description
1	TD+	Transmission Data +
2	TD-	Transmission Data -
3	RD+	Receive Data +
4	nu	not used
5	nu	not used
6	RD-	Receive Data -
7	nu	not used
8	nu	not used

Pin assignment of the D-Sub 15-pin sensor connector according to the respective operating manual (→ [1], [2], [3]).

2 Plug the EtherCAT (and sensor) cables connector into the gauge: From the previous device the cable connected to OUT port has to be connected to the BCG450-SE <IN> port. And the cable from the BCG450-SE <OUT> port has to be connected to the next device's <IN> port.

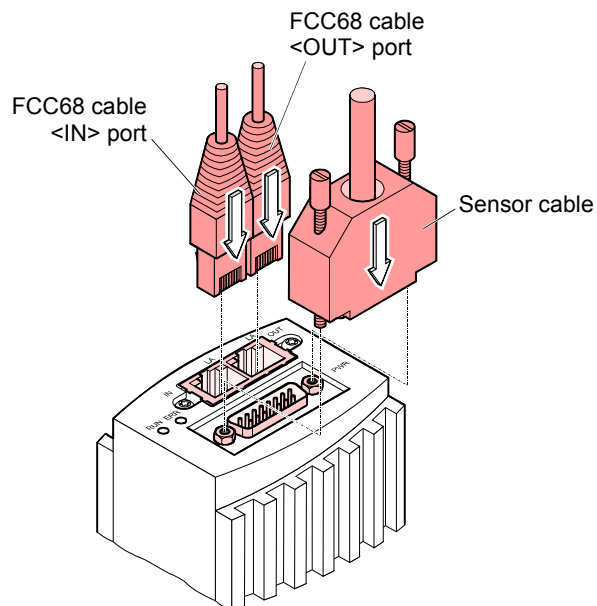

3 Operation

3.1 Introduction

Via the EtherCAT interface, the following and further data are exchanged in the standardized EtherCAT protocol:

- Pressure reading
- Pressure unit (Torr, mbar, Pa)
- Status and error messages
- Status of the switching functions
- Set Trip Point for switching functions



Caution



Caution: data transmission errors

Any attempt to simultaneously operate the gauge via the RS232C Serial Interface and EtherCAT interface or the diagnostic port may result in incorrect data and data transmission errors.

Therefore, it is inadmissible to simultaneously operate the gauge via the RS232C Serial Interface and EtherCAT interface or the diagnostic port.

3.2 Front View

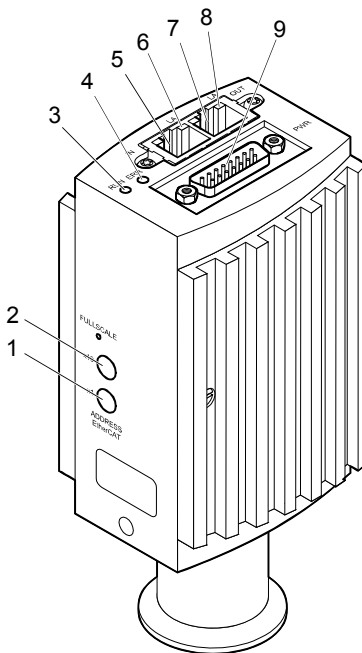

Position	Label	Function
1	x1	Address Switch × 1, hexadecimal
2	x10	Address Switch × 10, hexadecimal
3	RUN	EtherCAT Status LED
4	ERR	Error LED
5	IN	EtherCAT IN connector
6	LA	Link activity EtherCAT IN
7	OUT	EtherCAT OUT connector
8	LA	Link activity EtherCAT OUT
9	PWR	Sensor cable connector (Power, analog I/O, RS232C I/O and Relay contacts)

3.3 Indicators and Switches

3.3.1 <RUN> LED



Displays the operating status.

Color	LED State	Description
green	off	INIT (initialization status) or no power applied to device.
	blinking (200 ms on 200 ms off)	PREOP (pre-operational status).
	single flash (200 ms on 1000 ms off)	SAFEOP (safe-operational status). Communication of cyclic data transfer running. Input values available, output values written to the device but not updated on device output.
	on	OP (operational status).

3.3.2 <ERR> LED



Displays the error content.

Color	LED State	Description
red	off	No error or no power applied to device.
	blinking (200 ms on 200 ms off)	Error occurred (see error parameter).
	single flash (200 ms on 1000 ms off)	Slave device application has changed the EtherCAT state autonomously, due to local error (see error parameter).
	double flash (200 ms on 200 ms off 200 ms on 1000 ms off)	An application watchdog timeout has occurred. Sync Manager Watchdog timeout or communication timeout occurred.
	on	A critical communication or application controller error has occurred. Application controller is not responding any more (PDI Watchdog Timeout detected by ESC)

3.3.3 <LA> LED (<IN> Port)

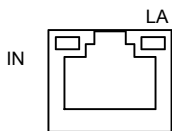

Displays the input status.

Color	LED State	Description
green	off	Port not connected or no power applied to device.
	blinking	Port connected and communication active.
	on	Port not connected but no communication.

3.3.4 <LA> LED (<OUT> Port)

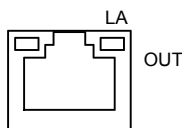

Displays the output status.

Color	LED State	Description
green	off	Port not connected or no power applied to device.
	blinking	Port connected and communication active.
	on	Port not connected but no communication.

3.3.5 Device Address Switch

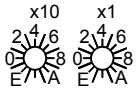

During device initialization, the device address switches are read by the device firmware. This device address is supported to the master as Explicit Device Identification.

Example: Value of the Explicit Device ID = 0xDD (dec 221):
 $0x10 * 0xD$ (dec 208) + $0x1 * 0xD$ (dec 13)

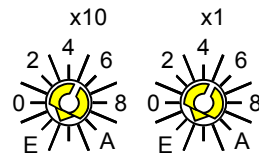

4 Object Structure

This chapter describes the CANopen over EtherCAT (CoE) Object Dictionary.

4.1 Object Dictionary structure

The objects in the CoE Object Dictionary can be accessed with SDO services, and many of the dictionary objects can be mapped for cyclic communication in PDOs. Each object is addressed using a 16-bit index and an 8-bit subindex.

The following table presents the overall layout of the standard Object Dictionary.

Index (hex.)	Object dictionary area	
1000 – 1FFF	Communication profile area	
2000 – 5FFF	Manufacturer-specific profile area	
6000 – 6FFF	Profile Specific Area	
7000 – 7FFF		Input area
8000 – 8FFF		Output area
9000 – 9FFF		Configuration area
A000 – AFFF		Information area
B000 – BFFF		Diagnosis area
C000 – CFFF		Service Transfer area
D000 – DFFF		Reserved area
E000 – EFFF		Device area

Explanations for the abbreviations in the columns of the tables are given below:

Abbr.	Description
Access	SDO read/write access <ul style="list-style-type: none"> RO: object can only be read by the SDO service RW: object can be both read and written by the SDO service
CoE	CAN application protocol over EtherCAT
Index	Object Index (hex.) (address of an object)
NV	Nonvolatile; attribute value is maintained through power cycles
Object	Abstract representation of a particular component within a device, which consists of data, parameters, and methods.
PDO	Process Data Object. Structure described by mapping parameters containing one or several process data entities.
PM	PDO mapping <ul style="list-style-type: none"> Rx: object can be mapped into an Rx PDO Tx : object can be mapped into a Tx PDO
RxPDO	Receive PDO. A Process Data Object received by an EtherCAT slave.
SDO	Service Data Objects. CoE asynchronous mailbox communications where all objects in the Object Dictionary can be read and written.
SI	Subindex (hex.) (sub-address of an object)
Type	Data Type <ul style="list-style-type: none"> BOOL, BIT = 1 bit. Boolean (0 = false, 1 = true) USINT, BYTE = 8 bit. Unsigned Byte UINT = 16 bit. Unsigned integer value UDINT = 32 bit. Unsigned integer value ULINT = 64 bit. Unsigned integer value REAL = 32 bit. Floating point V_STRING = 8×n bit. Visible string (1 byte for character)
TxPDO	Transmit PDO. A Process Data Object sent from an EtherCAT slave.

4.2 Communication Profile Objects (0x1000...0x1FFF)

The objects of the communication profile describe the basic EtherCAT properties of the BCG450-SE and are common to all EtherCAT slaves using the CoE communication protocol. The objects are described in following table:

Index	SI	DataType	NV	Access	PM	Name
1000		UDINT		RO		Device Type
1008		V_STRING		RO		Manufacturer Device name
1009		V_STRING		RO		Manufacturer Hardware Version
100A		V_STRING		RO		Manufacturer Software Version
1010	0x01	UDINT		RW		Store Parameters Read: Bit 0 = 1: slave saves the backup entries when writing 0x1010:01 with 0x65766173 Bit 1-31 = 0 Write: With the value 0x65766173 the backup entries will be stored to non-volatile memory of the slave
1011	0x01	UDINT		RW		Restore Default Parameters Read: Bit 0 = 1: slave supports the restoring of backup entries with the default values when writing 0x1011:01 with 0x64616F6C Bit 1-31 = 0 Write: With the value 0x64616F6C the backup entries will be restored with the default values
1018				RO		Identity Object
	0x01	UDINT		RO		Vendor ID
	0x02	UDINT		RO		Product Code
	0x03	UDINT		RO		Revision Number
	0x04	UDINT		RO		Serial Number
10F8		ULINT		RO		Timestamp Object

4.2.1 Process Data Objects (PDO's)

The BCG450 consists of three vacuum pressure sensors. The characteristic of this combo device is that only one vacuum pressure sensor outputs an actual pressure value at one time. The other sensor is in overrange condition which means that the pressure is higher than the measurement range of the sensor or underrange condition which means that the pressure is lower than the measurement of the sensor. The 'Combination Gauge Active Value' outputs the pressure value from the active measuring sensor.

For each sensor module a default mapping is configured. The mapping for each sensor module has the same contents. For a compact cyclic data frame duplicated mappings can be deactivated.

Or to meet other requirements the TxPDO's 1A01, 1A03, 1A05 or 1A07 and the RxPDO 1601 are designated for user mapping. These PDO's do not have default values and can be set up by the PDO configuration.

RxPDO's

Index	SI	Data Type	NV	Access	PM	Name
1600		PM		RW		RxPDO Receive PDO Mapping,
1601		PM		RW		RxPDO Receive PDO Mapping, User Mapping

TxPDO's

Index	SI	Data Type	NV	Access	PM	Name
1A00		PM		RW		TxPDO Transmit PDO Mapping
	0x01	BIT				Reading Valid Combination Gauge
	0x02	BIT				Overrange Exceeded Combination Gauge
	0x03	BIT				Underrange Exceeded Combination Gauge
	0x04	BIT				Padding Bits 1 (5 bit)
	0x05	REAL				Sensor Value Combination Gauge
	0x06	UINT				Active Sensor Number Combination Gauge
	0x07	UDINT				Trip Point Output All Instance
1A01		PM		RW		TxPDO Transmit PDO Mapping Module 1, User Mapping
1A02		PM		RW		TxPDO Transmit PDO Mapping Module 2
	0x01	BIT				Reading Valid Module 2
	0x02	BIT				Overrange Exceeded Module 2
	0x03	BIT				Underrange Exceeded Module 2
	0x04	BIT				Padding Bits 1 (5 bit)
	0x05	REAL				Sensor Value Module 2
1A03		PM		RW		TxPDO Transmit PDO Mapping Module 2, User Mapping
1A04 ¹⁾		PM		RW		TxPDO Transmit PDO Mapping Combination Gauge
	0x01	BIT				Reading Valid Combination Gauge
	0x02	BIT				Overrange Exceeded Combination Gauge
	0x03	BIT				Underrange Exceeded Combination Gauge
	0x04	BIT				Padding Bits 1 (5 bit)
	0x05	REAL				Sensor Value Combination Gauge
	0x06	UINT				Active Sensor Number Combination Gauge
	0x07	UDINT				Trip Point Output All Instance
1A05		PM		RW		TxPDO Transmit PDO Mapping Module 3, User Mapping

(continued)

(concluded)

1A06		PM		RW		TxPDO Transmit PDO Mapping Module 4
	0x01	BIT				Reading Valid Module 4
	0x02	BIT				Overrange Exceeded Combination Gauge
	0x03	BIT				Underrange Exceeded Combination Gauge
	0x04	BIT				Padding Bits 1 (5 bit)
	0x05	REAL				Sensor Value Combination Gauge
	0x06	UINT				Active Sensor Number Combination Gauge
	0x07	UDINT				Trip Point Output All Instance
1A07		PM		RW		TxPDO Transmit PDO Mapping Module 4, User Mapping
1C00	0x01 0x02 0x03 0x04	BYTE		RW		Sync Manager Type
1C12 / 1C13	0x01 0x02 0x03 0x04	UINT		RW		Sync Manager PDO Assignment
1C32 / 1C33	0x01 - 0x20			RW		Sync Manager Parameter

4.3 Manufacturer-specific Profile Objects (0x2000...0x5FFF)

The manufacturer-specific profile objects contain the manufacturer's model number and device configuration data, status and diagnostic data. The objects are described in the following tables.

4.3.1 Configuration Capacitance Diaphragm Module 1

Subindex 0x02

Index	SI	DataType	NV	Access	PM	Name
4000	0x02	REAL		RW		Safe Value Module 1

Safe Value: The value to be used for Safe State = Safe Value.

4.3.2 Configuration Piezo Module 2

Subindex 0x02

Index	SI	DataType	NV	Access	PM	Name
4010	0x02	REAL		RW		Safe Value Module 2

Safe Value: The value to be used for Safe State = Safe Value.

4.3.3 Configuration Heat Transfer Module 3

Subindex 0x02

Index	SI	DataType	NV	Access	PM	Name
4020	0x02	REAL		RW		Safe Value Module 3

Safe Value: The value to be used for Safe State = Safe Value.

4.3.4 Configuration Hot Cathode Ion Module 4

Index	SI	DataType	NV	Access	PM	Name
4030	0x02	REAL		RW		Safe Value Module 4

Subindex 0x02

Safe Value: The value to be used for Safe State = Safe Value.

4.4 Input Area (0x6000...0x6FFF)

4.4.1 Input Common Capacitance Diaphragm

Index	SI	Data Type	NV	Access	PM	Name
6000	0x0E	BOOL		RO	tx	TxPdoState Module 1
	0x11	REAL		RO	tx	Sensor Value Module 1

Subindex 0x0E

Is set if the device is not in Safe State (value (I 0x6nn0, SI 0x11) = valid)

TxPdoState Module 1	
0	Invalid
1	Valid

Subindex 0x11

The corrected, converted, calibrated final analog input value of the sensor.

4.4.2 Input Capacitance Diaphragm

Index	SI	Data Type	NV	Access	PM	Name
6001	0x01	BOOL		RO	tx	Reading Valid Module 1
	0x02	BOOL		RO	tx	Overrange Exceeded Module 1
	0x03	BOOL		RO	tx	Underrange Exceeded Module 1

Subindex 0x01

Indicates whether the Value parameter contains a valid value within the specified accuracy or not.

Reading Valid Module 1	
0	Invalid
1	Valid

Subindex 0x02

Indicates whether the Value parameter contains a value in over range.

Reading Valid Module 1	
0	No Overrange Exceeded
1	Overrange Exceeded

Subindex 0x03

Indicates whether the Value parameter contains a value in under range.

Reading Valid Module 1	
0	No Underrange Exceeded
1	Underrange Exceeded

4.4.3 Input Common Piezo

Index	SI	Data Type	NV	Access	PM	Name
6010	0x0E	BOOL		RO	tx	TxPdoState Module 2
	0x11	REAL		RO	tx	Sensor Value Module 2

Subindex 0x0E

Is set if the device is not in Safe State (value (I 0x6010, SI 0x11) = valid)

TxPdoState Module 2	
0	Invalid
1	Valid

Subindex 0x11

The corrected, converted, calibrated final analog input value of the sensor.

4.4.4 Input Piezo

Index	SI	DataType	NV	Access	PM	Name
6012	0x01	BOOL		RO	tx	Reading Valid Module 2
	0x02	BOOL		RO	tx	Ovrange Exceeded Module 2
	0x03	BOOL		RO	tx	Underrange Exceeded Module 2

Subindex 0x01

Indicates whether the Value parameter contains a valid value within the specified accuracy or not.

Reading Valid Module 2	
0	Invalid
1	Valid

Subindex 0x02

Indicates whether the Value parameter contains a value in over range.

Reading Valid Module 2	
0	No Ovrange Exceeded
1	Ovrange Exceeded

Subindex 0x03

Indicates whether the Value parameter contains a value in under range.

Reading Valid Module 3	
0	No Underrange Exceeded
1	Underrange Exceeded

4.4.5 Input Common Heat Transfer

Index	SI	DataType	NV	Access	PM	Name
6020	0x0E	BOOL		RO	tx	TxPdoState Module 3
	0x11	REAL		RO	tx	Sensor Value Module 3

Subindex 0x0E

Is set if the device is not in Safe State (value (I 0x6020, SI 0x11) = valid)

TxPdoState Module 3	
0	Invalid
1	Valid

Subindex 0x11

The corrected, converted, calibrated final analog input value of the sensor.

4.4.6 Input Heat Transfer

Index	SI	Data Type	NV	Access	PM	Name
6023	0x01	BOOL		RO	tx	Reading Valid Module 3
	0x02	BOOL		RO	tx	Overrange Exceeded Module 3
	0x03	BOOL		RO	tx	Underrange Exceeded Module 3

Subindex 0x01

Indicates whether the Value parameter contains a valid value within the specified accuracy or not.

Reading Valid Module 4	
0	Invalid
1	Valid

Subindex 0x02

Indicates whether the Value parameter contains a value in over range.

Reading Valid Module 4	
0	No Overrange Exceeded
1	Overrange Exceeded

Subindex 0x03

Indicates whether the Value parameter contains a value in under range.

Reading Valid Module 4	
0	No Underrange Exceeded
1	Underrange Exceeded

4.4.7 Input Common Hot Cathode Ion

Index	SI	Data Type	NV	Access	PM	Name
6030	0x0E	BOOL		RO	tx	TxPdoState Module 4
	0x11	REAL		RO	tx	Sensor Value Module 4

Subindex 0x0E

Is set if the device is not in Safe State (value (I 0x6020, SI 0x11) = valid)

TxPdoState Module 4	
0	Invalid
1	Valid

Subindex 0x11

The corrected, converted, calibrated final analog input value of the sensor.

4.4.8 Input Hot Cathode Ion

Index	SI	Data Type	NV	Access	PM	Name
6035	0x01	BOOL		RO	tx	Reading Valid Module 4
	0x02	BOOL		RO	tx	Overrange Exceeded Module 4
	0x03	BOOL		RO	tx	Underrange Exceeded Module 4
	0x05	BOOL		RO	tx	Emission Status Off/On Module 4
	0x06	BOOL		RO	tx	Degas Status Off/On Module 4

Subindex 0x01

Indicates whether the Value parameter contains a valid value within the specified accuracy or not.

Reading Valid Module 4	
0	Invalid
1	Valid

Subindex 0x02

Indicates whether the Value parameter contains a value in over range.

Reading Valid Module 4	
0	No Overrange Exceeded
1	Overrange Exceeded

Subindex 0x03

Indicates whether the Value parameter contains a value in under range.

Reading Valid Module 4	
0	No Underrange Exceeded
1	Underrange Exceeded

Subindex 0x05

Emission Status Off/On Module 4	
0	OFF
1	ON

Subindex 0x06

Degas Status Off/On Module 4	
0	OFF
1	ON

4.4.9 Input Trip Point 1

Index	SI	DataType	NV	Access	PM	Name
600E	0x01	BOOL		RO	tx	Status High Trip TP1
	0x02	BOOL		RO	tx	Status Low Trip TP1
600F	0x01	BOOL		RO	tx	Status High Trip TP2
	0x02	BOOL		RO	tx	Status Low Trip TP2

Subindex 0x01

Status High Trip	
0	High Trip not assert
1	High Trip assert

Subindex 0x02

Status Low Trip	
0	Low Trip not assert
1	Low Trip assert

4.5 Configuration Area (0x8000...0x8FFF)

4.5.1 Configuration Hot Cathode Ion

Index	SI	Data Type	NV	Access	PM	Name
8035	0x02	BOOL	x	RW		Emission User Mode Module 4
	0x13	REAL	x	RW		Emission Current Module 4

Subindex 0x02

Defines whether the emission is switched on automatically (controlled by a different sensor) (automatic) or manually by the user (manual)

Filament User Mode Module 4	
0	Automatic
1	Manual

Subindex 0x13

Emission current in milliamps

4.5.2 Configuration Trip Point 1

If High Trip Source Index is 0x60101100

The High Trip Point is calculated by:

$$\text{High Trip Point Limit} = \text{Value}^{*)} \times \text{Percentage}^{**)}$$

*) Value from Piezo Sensor (I: 0x6010, SI: 0x11)

**) Percentage High Trip Source (I: 0x800E/F, SI: 0x13)

In this case, the High Trip Point Limit value is automatically updated by the device itself. Any user-written value to the parameter High Trip Point Limit will be refused with an abort code.

If High Trip Source Index is 0x800E1100 or 0x800F1100 the High Trip Point is equal with the value referenced in High Trip Point Limit.

The value defined in High Trip Point Limit is compared with the pressure value referenced by the Source Index parameter.

If Low Trip Source Index is 0x60101100

The Low Trip Point is calculated by:

$$\text{Low Trip Point Limit} = \text{Value}^{*)} \times \text{Percentage}^{**)}$$

*) Value from Piezo Sensor (I: 0x6010, SI: 0x11)

**) Percentage Low Trip Source (I: 0x800E/F, SI: 0x16)

In this case, the Low Trip Point Limit value is automatically updated by the device itself. Any user-written value to the parameter Low Trip Point Limit will be refused with an abort code.

If Low Trip Source Index is 0x800E1400 or 0x800F1400 the Low Trip Point is equal with the value referenced in Low Trip Point Limit.

The value defined in Low Trip Point Limit is compared with the pressure value referenced by the Source Index parameter.

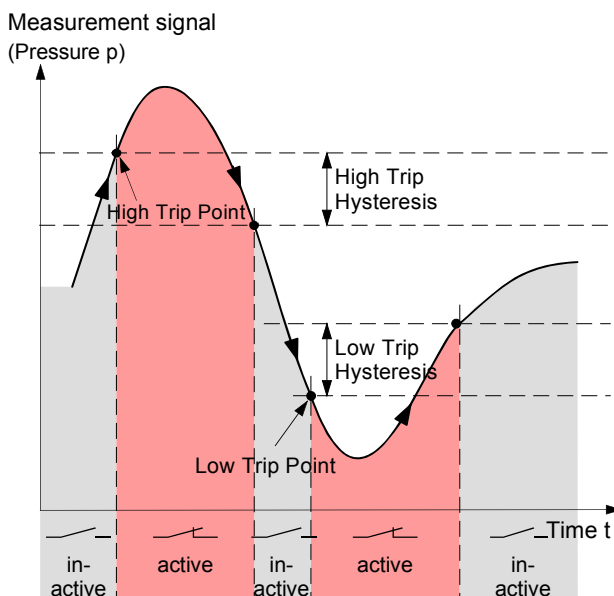

Index	SI	Data Type	NV	Access	PM	Name
800E	0x01	BOOL	x	RW		High Trip Enable TP1
	0x02	BOOL	x	RW		Low Trip Enable TP1
	0x04	BOOL	x	RW		Override Enable TP1
	0x05	BOOL	x	RW		Override High Trip TP1
	0x06	BOOL	x	RW		Override Low Trip TP1
	0x11	REAL	x	RW		High Trip Point Limit TP1
	0x12	UDINT	x	RW		High Trip Source Index TP1
	0x13	REAL	x	RW		Percentage High Trip Source TP1
	0x14	REAL	x	RW		Low Trip Point Limit TP1
	0x15	UDINT	x	RW		Low Trip Source Index TP1
	0x16	REAL	x	RW		Percentage Low Trip Source TP1
	0x17	REAL	x	RW		High Trip Hysteresis TP1
	0x18	REAL	x	RW		Low Trip Hysteresis TP1
	0x1A	UDINT	x	RW		Source Index TP1

Subindex 0x01

High Trip Point	
0	Disable
1	Enable

Subindex 0x02

Low Trip Point	
0	Disable
1	Enable

Subindex 0x04

Override Enable	
0	Disable
1	Enable

Subindex 0x05

Override High Trip	
0	Disable
1	Enable

Subindex 0x06

Override Low Trip	
0	Disable
1	Enable

Subindex 0x11

High Trip Point Limit: High limit to trigger trip point condition if Input Value (I 0x900E, SI 0x01) is above this limit.

Subindex 0x12

Object index of High Trip Point Value source

Bit 16...31: Index
 Bit 08...15: Subindex
 Bit 00...07: reserved

It is possible to reference to "High Trip Point Limit" or to the sensor value from the Piezo Sensor (I 0x6010, SI 0x11).

Subindex 0x13

Percentage of Value referenced by High Trip Source Index (I 0x6010, SI 0x11) in [%]. If High Trip Source Index is I 0x800E, SI 0x12 this parameter is not used.

Subindex 0x14

Low Trip Point Limit: Low limit to trigger trip point condition if Input Value (I 0x900E, SI 0x01) is below this limit.

Subindex 0x15

Object index of Low Trip Point Value source. Index of Low Trip Point Limit (I 0x800E, SI 0x14)

Bit 16...31: Index
 Bit 08...15: Subindex
 Bit 00...07: reserved

It is possible to reference to "Low Trip Point Limit" or to the sensor value from the Piezo Sensor (I 0x6010, SI 0x11).

Subindex 0x16

Percentage of Value referenced by Low Trip Source Index (I 0x6010, SI 0x11) in [%]. If Low Trip Source Index is I 0x800E, SI 0x14 this parameter is not used.

Subindex 0x17

High Trip Hysteresis: Hysteresis value for High Trip Point.

Subindex 0x18

Low Trip Hysteresis: Hysteresis value for Low Trip Point.

Subindex 0x1A

Object index of active source of (I 0xF640 SI 0x11) Input Value.

Source Index	
Bit 16...31	Index
Bit 08...15	Subindex
Bit 00...07	Reserved

4.5.3 Configuration Trip Point 2

Calculating the High Trip Point and Low Trip Point → 4.4.7.

Index	SI	Data Type	NV	Access	PM	Name
800F	0x01	BOOL	x	RW		High Trip Enable TP2
	0x02	BOOL	x	RW		Low Trip Enable TP2
	0x04	BOOL	x	RW		Override Enable TP2
	0x05	BOOL	x	RW		Override High Trip TP2
	0x06	BOOL	x	RW		Override Low Trip TP2
	0x11	REAL	x	RW		High Trip Point Limit TP2
	0x12	UDINT	x	RW		High Trip Source Index TP2
	0x13	REAL	x	RW		Percentage High Trip Source TP2
	0x14	REAL	x	RW		Low Trip Point Limit TP2
	0x15	UDINT	x	RW		Low Trip Source Index TP2
	0x16	REAL	x	RW		Percentage Low Trip Source TP2 TP2
	0x17	REAL	x	RW		High Trip Hysteresis TP2
	0x18	REAL	x	RW		Low Trip Hysteresis TP2
	0x1A	UDINT	x	RW		Source Index TP2

Subindex 0x01

High Trip Point	
0	Disable
1	Enable

Subindex 0x02

Low Trip Point	
0	Disable
1	Enable

Subindex 0x04

Override Enable	
0	Disable
1	Enable

Subindex 0x05

Override High Trip	
0	Disable
1	Enable

Subindex 0x06

Override Low Trip	
0	Disable
1	Enable

Subindex 0x11

High Trip Point limit: High limit to trigger trip point condition if Input Value (I 0x900F, SI 0x01) is above this limit.

Subindex 0x12

Object index of High Trip Point Value source

Bit 16...31: Index
 Bit 08...15: Subindex
 Bit 00...07: reserved

It is possible to reference to "High Trip Point Limit" or to the sensor value from the Piezo Sensor (I 0x6010, SI 0x11).

- Subindex 0x13 Percentage of Value referenced by High Trip Source Index (I 0x6010, SI 0x11) in [%]. If High Trip Source Index is I 0x800F, SI 0x12 this parameter is not used.
- Subindex 0x14 Low Trip Point Limit: Low limit to trigger trip point condition if Input Value (I 0x900F, SI 0x01) is below this limit.
- Subindex 0x15 Object index of Low Trip Point Value source. Index of Low Trip Point Limit (I 0x800F, SI 0x14)
 - Bit 16...31: Index
 - Bit 08...15: Subindex
 - Bit 00...07: reserved
 It is possible to reference to "Low Trip Point Limit" or to the sensor value from the Piezo Sensor (I 0x6010, SI 0x11).
- Subindex 0x16 Percentage of Value referenced by Low Trip Source Index (I 0x6010, SI 0x11) in [%].If Low Trip Source Index is I 0x800F, SI 0x14 this parameter is not used.
- Subindex 0x17 High Trip Hysteresis: Hysteresis value for High Trip Point.
- Subindex 0x18 Low Trip Hysteresis: Hysteresis value for Low Trip Point.
- Subindex 0x1A Object index of active source of (I 0xF640 SI 0x11) Input Value.

Source Index	
Bit 16...31	Index
Bit 08...15	Subindex
Bit 00...07	Reserved

4.6 Information Area (0x9000...0x9FFF)

The Information Data object defines the input process data.

Highest / lowest measurement value

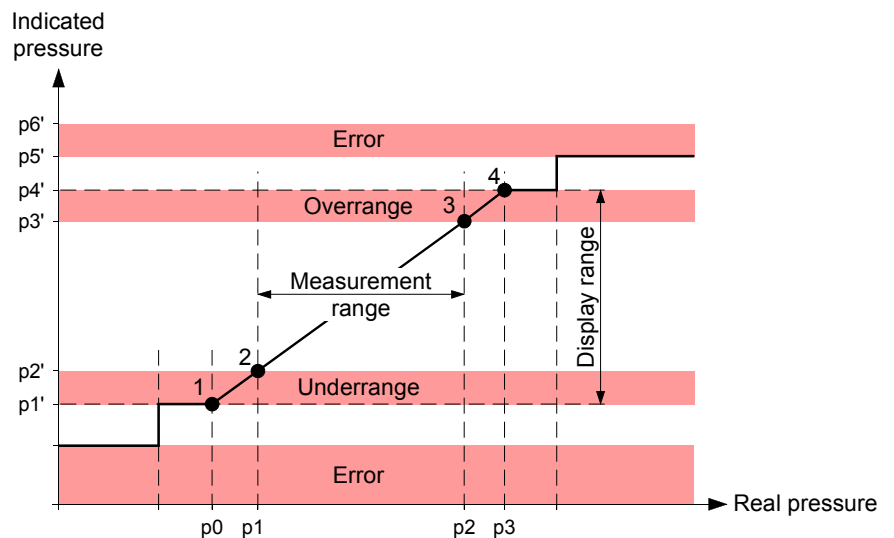

The "measurement range" is the range between minimum and maximum pressure, where the reading of the gauge is within the specified measurement uncertainty limits.

The "valid measurement information range" (display range) is the complete pressure range where the gauge gives an indication (measurement signal). The valid measurement information range (display range) consists of underrange, measurement range and overrange.

According to these definitions, 4 points are defined:

- 1 Lowest informational measurement value
- 2 Lowest precision measurement value
- 3 Highest precision measurement value
- 4 Highest informational measurement value

Index	SI	DataType	NV	Access	PM	Name
9000	0x02	REAL	x	RO		Highest Informational Measurement Value Module 1
	0x03	REAL	x	RO		Highest Precision Measurement Value Module 1
	0x04	REAL	x	RO		Lowest Precision Measurement Value Module 1
	0x05	REAL	x	RO		Lowest Informational Measurement Value Module 1

Subindex 0x02

Highest Informational Measurement Value: Highest value that the gauge can measure without a specified accuracy.

Subindex 0x03

Highest Precision Measurement Value: Highest valid value at which the gauge is specified with an accuracy value. Above that value, the parameter Reading Valid is set to invalid.

Subindex 0x04

Lowest Precision Measurement Value: Lowest valid value at which the gauge is specified with an accuracy value. Below that value, the parameter Reading Valid is set to invalid.

Subindex 0x05

Lowest value the gauge can measure without a specified accuracy.

4.6.1 Information Capacitance Diaphragm

Index	SI	DataType	NV	Access	PM	Name
9001	0x01	UINT		RO		Sensor Warning Module 1
	0x02	UINT		RO		Sensor Alarm Module 1

Subindex 0x01

Sensor Warnings	
Bit 0	0
Bit 1	Electronics Warning
Bit 2...15	0

Subindex 0x02

Sensor Alarms	
Bit 0	0
Bit 1	Electronics Failure
Bit 2...15	0

4.6.2 Information Common Piezo

Index	SI	Data Type	NV	Access	PM	Name
9010	0x02	REAL	x	RO		Highest Informational Measurement Value Module 2
	0x03	REAL	x	RO		Highest Precision Measurement Value Module 2
	0x04	REAL	x	RO		Lowest Precision Measurement Value Module 2
	0x05	REAL	x	RO		Lowest Informational Measurement Value Module 2

Subindex 0x02

Highest Informational Measurement Value: Highest value that the gauge can measure without a specified accuracy.

Subindex 0x03

Highest Precision Measurement Value: Highest valid value at which the gauge is specified with an accuracy value. Above that value, the parameter Reading Valid is set to invalid.

Subindex 0x04

Lowest Precision Measurement Value: Lowest valid value at which the gauge is specified with an accuracy value. Below that value, the parameter Reading Valid is set to invalid.

Subindex 0x05

Lowest value the gauge can measure without a specified accuracy.

4.6.3 Information Piezo

Index	SI	Data Type	NV	Access	PM	Name
9012	0x01	UINT		RO		Sensor Warning Module 2
	0x02	UINT		RO		Sensor Alarm Module 2

Subindex 0x01

Sensor Warnings	
Bit 0	0
Bit 1	Electronics Warning
Bit 2...15	0

Subindex 0x02

Sensor Alarms	
Bit 0	0
Bit 1	Electronics Failure
Bit 2...15	0

4.6.4 Information Common Heat Transfer

Index	SI	Data Type	NV	Access	PM	Name
9020	0x02	REAL	x	RO		Highest Informational Measurement Value Module 3
	0x03	REAL	x	RO		Highest Precision Measurement Value Module 3
	0x04	REAL	x	RO		Lowest Precision Measurement Value Module 3
	0x05	REAL	x	RO		Lowest Informational Measurement Value Module 3

Subindex 0x02 Highest Informational Measurement Value: Highest value that the gauge can measure without a specified accuracy.

Subindex 0x03 Highest Precision Measurement Value: Highest valid value at which the gauge is specified with an accuracy value. Above that value, the parameter Reading Valid is set to invalid.

Subindex 0x04 Lowest Precision Measurement Value: Lowest valid value at which the gauge is specified with an accuracy value. Below that value, the parameter Reading Valid is set to invalid.

Subindex 0x05 Lowest value the gauge can measure without a specified accuracy.

4.6.5 Information Heat Transfer

Index	SI	DataType	NV	Access	PM	Name
9023	0x01	UINT		RO		Sensor Warning Module 3
	0x02	UINT		RO		Sensor Alarm Module 3

Subindex 0x01

Sensor Warnings	
Bit 0	0
Bit 1	Electronics Warning
Bit 2...15	0

Subindex 0x02

Sensor Alarms	
Bit 0	0
Bit 1	Electronics Failure
Bit 2...15	0

4.6.6 Information Common Hot Cathode Ion

Index	SI	DataType	NV	Access	PM	Name
9030	0x02	REAL	x	RO		Highest Informational Measurement Value Module 4
	0x03	REAL	x	RO		Highest Precision Measurement Value Module 4
	0x04	REAL	x	RO		Lowest Precision Measurement Value Module 4
	0x05	REAL	x	RO		Lowest Informational Measurement Value Module 4

Subindex 0x02 Highest Informational Measurement Value: Highest value that the gauge can measure without a specified accuracy.

Subindex 0x03 Highest Precision Measurement Value: Highest valid value at which the gauge is specified with an accuracy value. Above that value, the parameter Reading Valid is set to invalid.

Subindex 0x04 Lowest Precision Measurement Value: Lowest valid value at which the gauge is specified with an accuracy value. Below that value, the parameter Reading Valid is set to invalid.

Subindex 0x05 Lowest value the gauge can measure without a specified accuracy.

4.6.7 Information Hot Cathode Ion

Index	SI	Data Type	NV	Access	PM	Name
9035	0x01	UINT		RO		Sensor Warning Module 4
	0x02	UINT		RO		Sensor Alarm Module 4

Subindex 0x01

Sensor Warnings	
Bit 0	Sensor Filament 1 Warning
Bit 1	Sensor Filament 2 Warning
Bit 2...8	0
Bit 9	Electronics Warning
Bit 10	0
Bit 11	Pressure to high for Degas
Bit 12...15	0

Subindex 0x02

Sensor Alarms	
Bit 0	Sensor Filament 1 Alarm
Bit 1	Sensor Filament 2 Alarm
Bit 2...8	0
Bit 9	Electronics Faliure
Bit 10	0
Bit 11	Overpressure Emission OFF
Bit 12...15	0

4.6.8 Information Trip Point 1/2

Index	SI	Data Type	NV	Access	PM	Name
900E	0x01	REAL		RO		Input Value Trip Point 1
900F	0x01	REAL		RO		Input Value Trip Point 2

Subindex 0x01 (900E)

Input Value Trip Point 1: Trip Point Input value as referenced by Source Index (I 0x800E, SI 0x0E).

Subindex 0x01 (900F)

Input Value Trip Point 2: 0 Trip Point Input value as referenced by Source Index (I 0x800F, SI 0x0E).

4.7 Device Area (0xF000...0xAFFF)

4.7.1 Semiconductor Device Profile

Index	SI	Data Type	NV	Access	PM	Name
F000	0x01	UINT		RO		Index Distance
	0x02	UINT		RO		Maximum Number of Modules

Subindex 0x01

Index Distance: Index offset between PDO entries of two consecutive modules (for ETG.5003 = 0x10), e.g. 0x6000, 0x6010.

Subindex 0x02

Maximum Number of Modules: For the BCG450 this value always is 4.

4.7.2 Module Profile List

Index	SI	Data Type	NV	Access	PM	Name
F010	0x01	UDINT		RO		Profile Number Module 1
	0x02	UDINT		RO		Profile Number Module 2
	0x03	UDINT		RO		Profile Number Module 3

	0x04	UDINT		RO		Profile Number Module 4
--	------	-------	--	----	--	-------------------------

Subindex 0x01 Each sub-index lists the profile-number of the corresponding module.

Subindex 0x02 Each sub-index lists the profile-number of the corresponding module.

Subindex 0x03 Each sub-index lists the profile-number of the corresponding module.

Subindex 0x04 Each sub-index lists the profile-number of the corresponding module.

4.7.3 Exceptions

4.7.4 Active Exception Status

Index	SI	Data Type	NV	Access	PM	Name
F380		USINT		RO	tx	ActiveException Status

Active Exception Status

Active Exception Status	
Bit 0	Device Warning
Bit 1	Manufacturer Warning
Bit 2	Device Error
Bit 3	Manufacturer Error
Bit 4...7	0

4.7.5 Active Device Warning Details

The "active device warning details" parameter describes the warning state of the complete device.

Index	SI	Data Type	NV	Access	PM	Name
F381	0x01	UDINT		RO	tx	Active Device Warning Details Device
	0x02	UDINT		RO	tx	Active Device Warning Details Module 1
	0x03	UDINT		RO	tx	Active Device Warning Details Module 2
	0x04	UDINT		RO	tx	Active Device Warning Details Module 3
	0x05	UDINT		RO	tx	Active Device Warning Details Module 4
F382	0x01	UDINT		RO	tx	Active Manufacturer Warning Details

Subindex 0x01

Active Device Warning Details (Index F381)	
Bit 0...2	0
Bit 3	EEPROM exception
Bit 4...31	0

Subindex 0x02

Active Device Warning Details Module 1 (Index F381)	
Bit 0	0
Bit 1	Electronics warning
Bit 2...31	0

Subindex 0x03

Active Device Warning Details Module 2 (Index F381)	
Bit 0...31	0

Subindex 0x04

Active Device Warning Details Module 3 (Index F381)	
Bit 0	0
Bit 1	Electronics warning
Bit 2...31	0

Subindex 0x05

Active Device Warning Details Module 4 (Index F381)	
Bit 0	0
Bit 1	Electronics warning
Bit 2...31	0

Subindex 0x01

Active Manufacturer Warning Details (Index F382)	
Bit 0	Internal Communication Exception (between EtherCAT-Protocol and Device-Application)
Bit 1...31	0

4.7.6 Active Device Error Details

The "active device error details" parameter describes the error state of the complete device.

Index	SI	Data Type	NV	Access	PM	Name
F383	0x01	UDINT		RO	tx	Active Device Error Details Device
	0x02	UDINT		RO	tx	Active Device Error Details Module 1
	0x03	UDINT		RO	tx	Active Device Error Details Module 2
	0x04	UDINT		RO	tx	Active Device Error Details Module 3
	0x05	UDINT		RO	tx	Active Device Error Details Module 4
F384	0x01	UDINT		RO	tx	Active Manufacturer Error Details

Subindex 0x01 (F383)

Active Device Error Details Device(Index F383)	
Bit 0	0
Bit 1	uP exception
Bit 2...31	0

Subindex 0x02 (F383)

Active Device Error Details Module 1(Index F383) Capacitance Diaphragm	
Bit 0	0
Bit 1	Electronics failure
Bit 2...31	0

Subindex 0x03 (F383)

Active Device Error Details Module 2(Index F383) Piezo	
Bit 0	0
Bit 1	Electronics failure
Bit 2...31	0

Subindex 0x04 (F383)

Active Device Error Details Module 3(Index F383) Heat Transfer	
Bit 0	0
Bit 1	Electronics failure
Bit 2...31	0

Subindex 0x05 (F383)

Active Device Error Details Module 4(Index F383) Hot Cathode	
Bit 0	0
Bit 1	Electronics failure
Bit 2...31	0

Subindex 0x01 (F384)

Active Manufacturer Error Details (Index F384)	
Bit 0	Internal Communication Exception (between EtherCAT-Protocol and Device-Application)
Bit 1	Wrong software version used in base device
Bit 2	Wrong sensor type detected
Bit 3...31	0

4.7.7 Latched Device Warning Details

Index	SI	Data Type	NV	Access	PM	Name
F390		USINT		RO	tx	Latched Exceptions Status
F391	0x01	UDINT		RO	tx	Latched Device Warning Details Device
	0x02	UDINT		RO	tx	Latched Device Warning Details Module 1
	0x03	UDINT		RO	tx	Latched Device Warning Details Module 2
	0x04	UDINT		RO	tx	Latched Device Warning Details Module 3
	0x05	UDINT		RO	tx	Latched Device Warning Details Module 4
F392	0x01	UDINT		RO	tx	Latched Manufacturer Warning Details

Latched Exceptions Status

Latched version of 0xF380.

Subindex 0x01 (F391)

Latched Device Warning Details Device: Latched version of 0xF381:01.

Subindex 0x02 (F391)

Latched Device Warning Details Module 1: Latched version of 0xF381:02.

Subindex 0x03 (F391)

Latched Device Warning Details Module 2: Latched version of 0xF381:03.

Subindex 0x04 (F391)

Latched Device Warning Details Module 3: Latched version of 0xF381:04.

Subindex 0x05 (F391)

Latched Device Warning Details Module 4: Latched version of 0xF381:05.

Subindex 0x01 (F392)

Latched Manufacturer Warning Details: Latched version of 0xF382:01.

4.7.8 Latched Device Error Details

Index	SI	Data Type	NV	Access	PM	Name
F393	0x01	UDINT		RO	tx	Latched Device Error Details Device
	0x02	UDINT		RO	tx	Latched Device Error Details Module 1
	0x03	UDINT		RO	tx	Latched Device Error Details Module 2
	0x04	UDINT		RO	tx	Latched Device Error Details Module 3
	0x05	UDINT		RO	tx	Latched Device Error Details Module 4
F394	0x01	UDINT		RO	tx	Latched Manufacturer Error Details

Subindex 0x01 (F393)

Latched Device Error Details Device: Latched version of 0xF383:01.

Subindex 0x02 (F393)

Latched Device Error Details Module 1: Latched version of 0xF383:02.

Subindex 0x03 (F393)

Latched Device Error Details Module 2: Latched version of 0xF383:03.

Subindex 0x04 (F393)

Latched Device Error Details Module 3: Latched version of 0xF383:04.

Subindex 0x05 (F393)

Latched Device Error Details Module 4: Latched version of 0xF383:05.

Subindex 0x01 (F394)

Latched Manufacturer Error Details: Latched version of 0xF384:01.

4.7.9 Device Warning Mask

Index	SI	Data Type	NV	Access	PM	Name
F3A1	0x01	UDINT	x	RW		Device Warning Mask Device
	0x02	UDINT	x	RW		Device Warning Mask Module 1
	0x03	UDINT	x	RW		Device Warning Mask Module 2
	0x04	UDINT	x	RW		Device Warning Mask Module 3
	0x05	UDINT	x	RW		Device Warning Mask Module 4
F3A2	0x01	UDINT	x	RW		Manufacturer Warning Mask

Subindex 0x01 (F3A1)

Device Warning Mask Device: Mask bits for 0xF381:01 and 0xF391:01.

Subindex 0x02 (F3A1)

Device Warning Mask Module 1: Mask bits for 0xF381:02 and 0xF391:02.

Subindex 0x03 (F3A1)

Device Warning Mask Module 2: Mask bits for 0xF381:03 and 0xF391:03.

Subindex 0x04 (F3A1)

Device Warning Mask Module 3: Mask bits for 0xF381:04 and 0xF391:04.

Subindex 0x05 (F3A1)

Device Warning Mask Module 4: Mask bits for 0xF381:05 and 0xF391:05.

Subindex 0x01 (F3A2)

Manufacturer Warning Mask: Mask bits for 0xF382:01 and 0xF392:01.

4.7.10 Device Error Mask

Index	SI	Data Type	NV	Access	PM	Name
F3A3	0x01	UDINT	x	RW		Device Error Mask Device
	0x02	UDINT	x	RW		Device Error Mask Module 1
	0x03	UDINT	x	RW		Device Error Mask Module 2
	0x04	UDINT	x	RW		Device Error Mask Module 3
	0x05	UDINT	x	RW		Device Error Mask Module 4
F3A4	0x01	UDINT	x	RW		Manufacturer Error Mask

Subindex 0x01 (F3A3)

Device Error Mask Device: Mask bits for 0xF383:01 and 0xF393:01.

Subindex 0x02 (F3A3)

Device Error Mask Module 1: Mask bits for 0xF383:02 and 0xF393:02.

Subindex 0x03 (F3A3)

Device Error Mask Module 2: Mask bits for 0xF383:03 and 0xF393:03.

Subindex 0x04 (F3A3)

Device Error Mask Module 3: Mask bits for 0xF383:04 and 0xF393:04.

Subindex 0x05 (F3A3)

Device Error Mask Module 4: Mask bits for 0xF383:05 and 0xF393:05.

Subindex 0x01 (F3A4)

Manufacturer Error Mask: Mask bits for 0xF384:01 and 0xF394:01.

4.7.11 Combination Gauge

Index	SI	Data Type	NV	Access	PM	Name
F640	0x01	BOOL		RO	tx	Combination Gauge Reading Valid
	0x02	BOOL		RO	tx	Combination Gauge Overrange Exceeded
	0x03	BOOL		RO	tx	Combination Gauge Underrange Exceeded
	0x11	REAL		RO	tx	Combination Gauge Active Value
	0x12	UINT		RO	tx	Combination Gauge Active Sensor Number

Subindex 0x01

Identifies whether the complete vacuum pressure gauge (with several measuring principles) is out of its absolute overrange or absolute underrange, or in any other failure condition.

Subindex 0x02

If the bit "Overrange" is set, all modules of the gauge are in an overrange condition.

Subindex 0x03

If the bit "Underrange" is set, all modules of the gauge are in an underrange condition

Subindex 0x11

The value copied from the measurement value of the active measuring module used for the Input PDO.

Subindex 0x12

Identifies the module that is providing the measurement value, the latter of which is copied into the Active Value parameter for all Input PDO's.

0	No module has a valid value
1	Capacitance diaphragm sensor is providing the Active Value
2	Piezo sensor is providing the Active Value
3	Heat Transfer sensor is providing the Active Value
4	Hot Cathode sensor is providing the Active Value

4.7.12 Trip Point Output All

Index	SI	Data Type	NV	Access	PM	Name
F641	0x01	UDINT		RO	tx	Trip Point Output All Instance

Subindex 0x01

Status of Trip Point instances.

Trip Point Output All Instance	
Bit 0	Status High Trip (I 0x600E, SI 0x01)
Bit 1	Status Low Trip (I 0x600E S, I 0x02)
Bit 2	Status High Trip (I 0x600F, SI 0x01)
Bit 3	Status Low Trip (I 0x600F, SI 0x02)
Bit 4...31	0

4.7.13 Input Latch Local Timestamp

Index	SI	Data Type	NV	Access	PM	Name
F6F0	0x01	UDINT		RO	tx	Input Latch Local Timestamp module 1
	0x02	UDINT		RO	tx	Input Latch Local Timestamp module 2
	0x03	UDINT		RO	tx	Input Latch Local Timestamp module 3
	0x04	UDINT		RO	tx	Input Latch Local Timestamp module 4

Subindex 0x01

Local controller time corresponding to the input latch time in microseconds. It starts at zero on device power-up. Mandatory if device has inputs. If device has no inputs defined, this corresponds the time immediately prior to writing to input SM.

Subindex 0x02

Local controller time corresponding to the input latch time in microseconds. It starts at zero on device power-up. Mandatory if device has inputs. If device has no inputs defined, this corresponds the time immediately prior to writing to input SM.

Subindex 0x03

Local controller time corresponding to the input latch time in microseconds. It starts at zero on device power-up. Mandatory if device has inputs. If device has no inputs defined, this corresponds the time immediately prior to writing to input SM.

Subindex 0x04

Local controller time corresponding to the input latch time in microseconds. It starts at zero on device power-up. Mandatory if device has inputs. If device has no inputs defined, this corresponds the time immediately prior to writing to input SM.

4.7.14 Configure Device

Index	SI	Data Type	NV	Access	PM	Name
F840	0x01	UDINT	x	RW		Data Units
	0x02	V_STRING		RW		Password

Subindex 0x01

Unit of the Value of the Analog Input Sensor Instance and all related parameters.

Trip Point Output All Instance	
0x00220000	Pascal
0xFD4E0000	mbar
0x00A10000	Torr
0x00E00000	Counts (INFICON)

Subindex 0x02

Writing the corresponding password (vendor specified value) enables Access Rights (Index F940 Subindex 03)

4.7.15 Information Device

Index	SI	Data Type	NV	Access	PM	Name
F940	0x01	UDINT		RO		Measurement Principle
	0x02	BYTE		RO		Number of Sensors
	0x03	USINT		RO		Access Rights
	0x04	V_STRING	x	RO		SW Version VPG PCB
F9F0		V_STRING		RO		Manufacturer Serial Number
F9F1	0x01	UDINT		RO		CDP Functional Generation Number Module 1
	0x02			RO		CDP Functional Generation Number Module 2
	0x03			RO		CDP Functional Generation Number Module 3
	0x04			RO		CDP Functional Generation Number Module 4
F9F2	0x01	UDINT		RO		SDP Functional Generation Number Module 1
	0x02	UDINT		RO		SDP Functional Generation Number Module 2
	0x03	UDINT		RO		SDP Functional Generation Number Module 3
	0x04	UDINT		RO		SDP Functional Generation Number Module 4
F9F3		V_STRING		RO		Vendor Name
F9F4	0x01	V_STRING		RO		Semiconductor SDP Device Name Module 1
	0x02	V_STRING		RO		Semiconductor SDP Device Name Module 2
	0x03	V_STRING		RO		Semiconductor SDP Device Name Module 3
	0x04	V_STRING		RO		Semiconductor SDP Device Name Module 4
F9F5	0x01	USINT		RW	rx tx	Output Identifier Module 1
	0x02	USINT		RW	rx tx	Output Identifier Module 2
	0x03	USINT		RW	rx tx	Output Identifier Module 3
	0x04	USINT		RW	rx tx	Output Identifier Module 4
F9F6		UDINT		RO		Time since power on
F9F7		UDINT	x	RO		Total time powered
F9F8		UDINT		RO		Firmware Update Functional Generation Number

Subindex 0x01 (F940)

Measurement principle assigned to the object instance.

The most significant nibble of the parameter represents the sensor type of the first Module, the second most significant nibble of the parameter represents the sensor type of the second Module, and so forth.

Measurement Principle (Index F940)	
1	Capacitance Manometer
2	Piezo
3	Heat Transfer
4	Cold Cathode
5	Hot Cathode

Subindex 0x02 (F940)

Number of Sensors (Index F940): In this device are 4 sensors implemented.

Subindex 0x03 (F940)

Access Rights (Index F940)	
0	User access to measurement and limited diagnostic features
1	Service access to additional diagnostic features (vendor specific)
2	Superuser access to vendor-specific parameters and features, e.g. calibration parameters, model number, serial numbers

Subindex 0x04 (F940)

Software version of the basic device.

4.7.16 Command Full Scale Adjust

Execution of this command will start a Full Scale Adjust operation.

Index	SI	DataType	NV	Access	PM	Name
FB41	0x01	V_STRING		RW		Command
	0x02	BYTE		RO		Status
	0x03	V_STRING(3)		RO		Response

Subindex 0x01

A full scale adjust command is initiated when the following byte sequence is sent.

Command	
Byte 0	0: Full Scale Adjust
Byte 1	Index of the Sensor Module. Value has to be 1 1: Capacitance Diaphragm
Byte 2...5	Full Scale value (Data format: REAL). Value has to be 0

Subindex 0x02

Status (supported values)	
0	Last command completed, no errors, no reply available
1	Last command completed, no errors, reply available
2	Last command completed, errors present, no reply available
3	Last command completed, errors present, reply available
255	Command is executing

Subindex 0x03

Response	
Byte 0	See Subindex 0x02
Byte 1	Unused
Byte 2	0: Full Scale Adjust successful 1: Full Scale Adjust failed: out-of-range 254: No previous Full Scale Adjust command issued

4.7.17 Command Degas ON / OFF

Execution of this command will initiate or cancel a degas operation.

Index	SI	Data Type	NV	Access	PM	Name
FB43	0x01	V_STRING(2)		RW		Command
	0x02	BYTE		RO		Status
	0x03	V_STRING(3)		RO		Response

Subindex 0x01

A degas command is initiated when the following byte sequence is sent.

Command	
Byte 0	0: Degas OFF 1: Degas ON
Byte 1	Index of the sensor module. Value has to be 4 4: Hot Cathode

Subindex 0x02

Status (supported values)	
0	Last command completed, no errors, no reply available
1	Last command completed, no errors, reply available
2	Last command completed, errors present, no reply available
3	Last command completed, errors present, reply available
255	Command is executing

Subindex 0x03

Response	
Byte 0	See Subindex 0x02
Byte 1	Unused
Byte 2	0: Degas ON / OFF successful 1: Degas ON / OFF failed (unspecified reason) 2: Degas On failed because pressure too high 254: No previous Degas ON / OFF command issued

4.7.18 Command Emission ON / OFF

Execution of this command will turn on or off the gauge's emission state.

Index	SI	Data Type	NV	Access	PM	Name
FB44	0x01	V_STRING(2)		RW		Command
	0x02	BYTE		RO		Status
	0x03	V_STRING(3)		RO		Response

Subindex 0x01

An emission command is initiated when the following byte sequence is sent.

Command	
Byte 0	0: Emission OFF 1: Emission ON
Byte 1	Index of the sensor module. Value has to be 4 4: Hot Cathode

Subindex 0x02

Status (supported values)	
0	Last command completed, no errors, no reply available
1	Last command completed, no errors, reply available
2	Last command completed, errors present, no reply available
3	Last command completed, errors present, reply available
255	Command is executing

Subindex 0x03

Response	
Byte 0	See Subindex 0x02
Byte 1	Unused
Byte 2	0: Emission ON / OFF successful 1: Emission ON / OFF failed (unspecified reason) 2: Emission On failed because pressure to high 254: No previous Emission ON / OFF command issued

4.7.19 Device Reset Command

Execution of this command causes the device to emulate a complete power cycle. This includes an ESC reset. An SDP may limit some behavior of the power cycle emulation, but shall not exclude the EtherCAT interface.



As consequence of an ESC reset all following devices are disconnected from the network.

There are two versions of this command:

- Standard reset (as described above)
- Factory reset (as described above, but additionally, all parameters are restored to as-shipped defaults).

Index	SI	Data Type	NV	Access	PM	Name
FBF0	0x01	V_STRING(6)		RW		Command
	0x02	BYTE		RO		Status
	0x03	V_STRING(1)		RO		Response

Subindex 0x01

A device reset is initiated when the following byte sequence is sent.

Command	
Byte 0	0x74
Byte 1	0x65
Byte 2	0x73
Byte 3	0x65
Byte 4	0x72
Byte 5	0x00 = Standard reset, 0x66 = Factory Reset

Subindex 0x02

Status (supported values)	
0	Reserved
1	Reserved
2	Last command completed, error, no response
3	Reserved
255	Command is executing

Subindex 0x03

Response	
Byte 0	See Subindex 0x02

4.7.20 Exception Reset Command

Execution of this command clears the latched exceptions.

Index	SI	Data Type	NV	Access	PM	Name
FBF1	0x01	V_STRING(5)		RW		Command
	0x02	BYTE		RO		Status
	0x03	V_STRING(1)		RO		Response

Subindex 0x01

A exception reset is initiated when the following byte sequence is sent.

Command	
Byte 0	0x74
Byte 1	0x65
Byte 2	0x73
Byte 3	0x65
Byte 4	0x72

Subindex 0x02

Status (supported values)	
0	Last command completed, no error, no response
1	Reserved
2	Last command completed, error, no response
3	Reserved
255	Command is executing

Subindex 0x03

Response	
Byte 0	See Subindex 0x02

4.7.21 Store Parameters Command

Execution of this command will store all parameters to non-volatile memory. If a device automatically saves all non-volatile parameters at the time they are set, this command will not take any action.

Index	SI	Data Type	NV	Access	PM	Name
FBF2	0x01	V_STRING(4)		RW		Command
	0x02	BYTE		RO		Status
	0x03	V_STRING(1)		RO		Response

Subindex 0x01

A device reset is initiated when the following byte sequence is sent.

Command	
Byte 0	0x65
Byte 1	0x76
Byte 2	0x61
Byte 3	0x73

Subindex 0x02

Status (supported values)	
0	Last command completed, no error, no response
1	Reserved
2	Last command completed, error, no response
3	Reserved
255	Command is executing

Subindex 0x03

Response	
Byte 0	See Subindex 0x02

Appendix

A: Literature

- [1] www.inficon.com
Instruction Sheet
TripleGauge™,
Bayard-Alpert Pirani Capacitance Diaphragm Gauge
BCG450, BCG450-SD, BCG450-SE, BCG450-SP
tima40d1 (German)
tima40e1 (English)
INFICON AG, LI-9496 Balzers, Liechtenstein
- [2] www.inficon.com
Instruction Sheet
TripleGauge™,
Bayard-Alpert Pirani Capacitance Diaphragm Gauge
BCG450-SD, BCG450-SE, BCG450-SP
tima41d1 (German)
tima41e1 (English)
INFICON AG, LI-9496 Balzers, Liechtenstein
- [3] www.inficon.com
Operating Manual
TripleGauge™,
Bayard-Alpert Pirani Capacitance Diaphragm Gauge
BCG450, BCG450-SD, BCG450-SE, BCG450-SP
tina40d1 (German)
tina40e1 (English)
INFICON AG, LI-9496 Balzers, Liechtenstein
- [4] ETG.1000.2: Physical Layer service definition and protocol specification
- [5] ETG.1000.3: Data Link Layer service definition
- [6] ETG.1000.4: Data Link Layer protocol specification
- [7] ETG.1000.5: Application Layer service definition
- [8] ETG.1000.6: Application Layer protocol specification
- [9] ETG.1020: EtherCAT Protocol Enhancements
- [10] ETG.2000: EtherCAT Slave Information
- [11] ETG.5001.1: Modular Device Profile – Part 1: General MDP Device Model
- [12] ETG.5003.1: Semiconductor Device profile – Part 1: Common Device Profile (CDP)
- [13] ETG.5003.2080: Semiconductor Device profile – Part 2080: Specific Device Profile (SDP): Vacuum Pressure Gauge
- [14] IEC 61158-x-12 (all parts for type 12): Industrial communication networks – Fieldbus specifications
- [15] IEC 61784-2: Industrial communication networks – Profiles – Part 2: Additional fieldbus profiles for real-time networks based on ISO/IEC 8802-3
- [16] SEMI E54 / Draft 5102A: SPECIFICATION FOR SENSOR/ACTUATOR NETWORK SPECIFIC DEVICE MODEL FOR VACUUM PRESSURE GAUGES
- [17] SEMI E52: Practice for referencing gases, gas mixtures and vaporizable materials used in digital mass flow controllers

Notes

Original: English tira87e1 (2014-10)



tira87e1



*LI-9496 Balzers
Liechtenstein
Tel +423 / 388 3111
Fax +423 / 388 3700
reachus@inficon.com*

www.inficon.com