

Capacitance Diaphragm Gauge

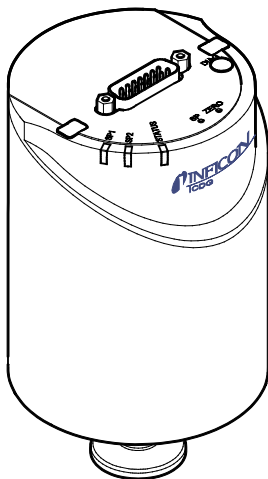



CDG100D 4-20 mA Current Loop



Operating Manual
Incl. EU Declaration of Conformity

Product Identification

In all communications with INFICON, please specify the information given on the product nameplate. For convenient reference copy that information into the space provided below.

INFICON AG, LI-9496 Balzers			
Model:			
PN:			
SN:			
..... V W; LPS		3103457	

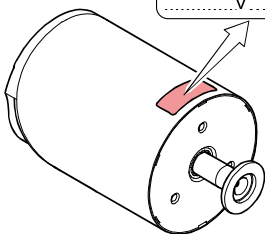

Validity

This document applies to products of the CDG100D 4-20 mA Current Loop series.

Part numbers of standard products are indicated below. OEM products have other part numbers and different parameter settings (e.g. factory setting of setpoint) as defined in the corresponding ordering information.

3CD1-xxx-23E0

Flange	1 ⇒ DN 16 ISO-KF 3 ⇒ DN 16 CF-R 9 ⇒ ½" tube C ⇒ 4 VCR male D ⇒ 4 VCR female E ⇒ 8 VCR female H ⇒ 8 VCR female, long tube
Unit	5 ⇒ Torr (×133 Pa; ×1.3 mbar) 6 ⇒ mbar (×100 Pa)
Measurement range (F.S.)	3 ⇒ 0.1 4 ⇒ 0.25 5 ⇒ 0.5 6 ⇒ 1 7 ⇒ 2 8 ⇒ 5 9 ⇒ 10 A ⇒ 20 B ⇒ 50 C ⇒ 100 D ⇒ 200 E ⇒ 500 F ⇒ 1000 (Torr only) G ⇒ 1100 (mbar only)

The part number (PN) can be taken from the product nameplate. If not indicated otherwise in the legends, the illustrations in this document correspond to gauges with DN 16 ISO-KF vacuum connection. They apply to the gauges with other vacuum connections by analogy.

We reserve the right to make technical changes without prior notice.

Intended Use

The temperature compensated Capacitance Diaphragm Gauges of the CDG100D 4-20 Current Loop series are intended for absolute pressure measurement of gases in their respective pressure ranges (→  2).

The gauges belong to the SKY® Smart Sensors family and can be operated in connection with an appropriate controller.

Functional Principle

A ceramic diaphragm is deflected by pressure. The deflection is measured capacitively and converted into a DC current output signal by the digital electronics.

The output signal is independent of the gas type.

Very accurate pressure measurement is achieved by heating the sensor to a constant temperature of 100 °C which results in a compensation of changes in the ambient conditions and a reduced deposition of process products and by-products in process applications.

Trademarks

SKY® INFICON Holding AG
VCR® Swagelok Marketing Co.

Patents

EP 1070239 B1, 1040333 B1

US Patents 6528008, 6591687, 7107855, 7140085

Scope of Delivery

- 1× gauge CDG100D
- 1× insulation shell
- 1× pin for adjusting settings via buttons
- 1× Calibration Test Report
- 1× Operating Manual German
- 1× Operating Manual English

Contents

Product Identification	2
Validity	2
Intended Use	4
Functional Principle	4
Trademarks	4
Patents	4
Scope of Delivery	5
1 Safety	7
1.1 Symbols Used	7
1.2 Personnel Qualifications	7
1.3 General Safety Instructions	8
1.4 Liability and Warranty	8
2 Technical Data	9
3 Installation	15
3.1 Vacuum Connection	15
3.2 Power Connection	19
4 Operation	21
4.1 Status Indication	21
4.2 Zeroing the Gauge	22
4.2.1 <ZERO> Adjustment	22

4.3	Switching Functions	26
4.4	Activating the Factory Setting (Factory Reset)	29
4.5	Diagnostic Port (RS232C Interface)	30
5	Deinstallation	31
5.1	Power Connection	31
5.2	Vacuum connection	31
6	Maintenance, Repair	34
7	Returning the Product	34
8	Disposal	35
9	Accessories	36
	ETL Certification	36
	EU Declaration of Conformity	37

For cross-references within this document, the symbol (→  XY) is used.

1 Safety

1.1 Symbols Used



DANGER

Information on preventing any kind of physical injury.



WARNING

Information on preventing extensive equipment and environmental damage.



Caution

Information on correct handling or use. Disregard can lead to malfunctions or minor equipment damage.



Notice

1.2 Personnel Qualifications



Skilled personnel

All work described in this document may only be carried out by persons who have suitable technical training and the necessary experience or who have been instructed by the end-user of the product.

1.3 General Safety Instructions

- Adhere to the applicable regulations and take the necessary precautions for the process media used.
Consider possible reactions with the product materials.
- Adhere to the applicable regulations and take the necessary precautions for all work you are going to do and consider the safety instructions in this document.
- Before beginning to work, find out whether any vacuum components are contaminated. Adhere to the relevant regulations and take the necessary precautions when handling contaminated parts.

Communicate the safety instructions to all other users.

1.4 Liability and Warranty

INFICON assumes no liability and the warranty becomes null and void if the end-user or third parties

- disregard the information in this document
- use the product in a non-conforming manner
- make any kind of interventions (modifications, alterations etc.) on the product
- use the product with accessories not listed in the product documentation.

The end-user assumes the responsibility in conjunction with the process media used.

Gauge failures due to contamination are not covered by the warranty.

2 Technical Data

Measurement range	→ "Validity"
Accuracy ¹⁾	
≤0.5 Torr/mbar F.S.	0.4% of reading
≥1 Torr/mbar F.S.	0.2% of reading
Temperature effect on zero	
≤0.5 Torr/mbar F.S.	0.0050% F.S./ °C
≥1 Torr/mbar F.S.	0.0025% F.S./ °C
Temperature effect on span	0.02% of reading / °C
Resolution	0.003% F.S.
Gas type dependence	none
<hr/>	
Output signal (measurement signal)	2-wire, current loop
Signal range	3.8 ... 20.4 mA
Measurement range (zero ... F.S.)	4.0 ... 20.0 mA
Error status	22.8 mA
Relationship current-pressure	linear
Loaded impedance R _L	
18.5 ... 33.3 V (dc) ²⁾	500 Ω
16.2 ... 31.0 V (dc) ²⁾	400 Ω
13.9 ... 28.8 V (dc) ²⁾	300 Ω
11.7 ... 26.5 V (dc) ²⁾	200 Ω
9.4 ... 24.2 V (dc) ²⁾	100 Ω
Response time ³⁾	
≥0.25 Torr/mbar (F.S.)	100 ms
0.05 / 0.1 Torr/mbar (F.S.)	130 ms



¹⁾ Non-linearity, hysteresis, repeatability in the calibrated range at 25 °C ambient operating temperature without temperature effects after operation of 2 h.

²⁾ Supply voltage current interface.

³⁾ Increase 10 ... 90 % F.S.R.

Identification	
Resistance R_{Ident}	13.2 k Ω referenced to supply common
Voltage	≤ 5 V
Remote Zero Adjust	digital input for zero adjustment with external switching contact (\rightarrow 22)
External switching contact	30 V (dc) / < 5 mA (dc)
Pulse	> 1 s ... < 5 s
Switching functions	SP1, SP2
Setting range	0 ... 99% F.S. (0 ... 9.9 V)
Hysteresis	1% F.S.
Relay contact	30 V (dc) / ≤ 0.5 A (dc) floating (NO)
closed	$p \leq p_{\text{SP}}$ (LED lit solid)
open	$p \geq p_{\text{SP}}$ (LED off)
Switching time	≤ 50 ms
Status relay	
Relay contact	30 V (dc) / ≤ 0.5 A (dc) connected to supply common (pin 5)
closed	measurement mode warning
open	no supply voltage warning up error
Diagnostic port	Jack connector, 2.5 mm, 3-pin

Supply

		DANGER
	<p>The gauge may only be connected to power supplies, instruments or control devices that conform to the requirements of a grounded protective extra-low voltage and limited power source (LPS), Class 2. The connection to the gauge has to be fused.</p>	

Supply voltage at the gauge	Class 2 / LPS +14 ... +30 V (dc) or ±15 V (±5%)
Ripple	≤1 V _{pp}
Power consumption while being heated	≤15 W
at operating temperature	≤10 W
Fuse to be connected	1.6 AT

The gauge is protected against reverse polarity of the supply voltage and overload.

Electrical connection	15-pin D-sub, male
Sensor cable CDG	15-pin plus shielding

Cable length CDG	
Supply voltage 15 V	≤ 8 m (0.14 mm ² /conductor) ≤15 m (0.25 mm ² /conductor)
Supply voltage 24 V	≤43 m (0.14 mm ² /conductor) ≤75 m (0.25 mm ² /conductor)
Supply voltage 30 V	≤88 m (0.14 mm ² /conductor) ≤135 m (0.25 mm ² /conductor)

For longer cables, larger conductor cross-sections are required ($R_{\text{cable}} \leq 1.0 \Omega$).

Cable length current interface	
<25 m	0.14 mm ² / conductor
25 ... 50 m	0.25 mm ² / conductor
>50 ... 300 m	0.50 mm ² / conductor

Grounding concept	→ "Power Connection"	
Materials exposed to vacuum	ceramics ($\text{Al}_2\text{O}_3 \geq 99.5\%$), stainless steel AISI 316L	
Internal volume	$\leq 4.2 \text{ cm}^3$	
Admissible pressure (absolute)		
200 / 500 / 1000 / 1100 F.S.	4 bar	400 kPa
1 / 2 / 5 / 10 / 20 / 50 / 100 F.S.	2.6 bar	260 kPa
0.1 / 0.25 / 0.5 F.S.	1.3 bar	130 kPa
Bursting pressure (absolute)	6 bar	600 kPa
Admissible temperatures		
Storage	-40 °C ... +65 °C	
Operation	+10 °C ... +40 °C	
Bakeout	$\leq 110 \text{ °C}$ at the flange	
Relative humidity	$\leq 80\%$ at temperatures $\leq +31 \text{ °C}$, decreasing to 50% at +40 °C	
Use	indoors only, altitude up to 2000 m	
Degree of protection	IP 40	

Dimensions [mm]

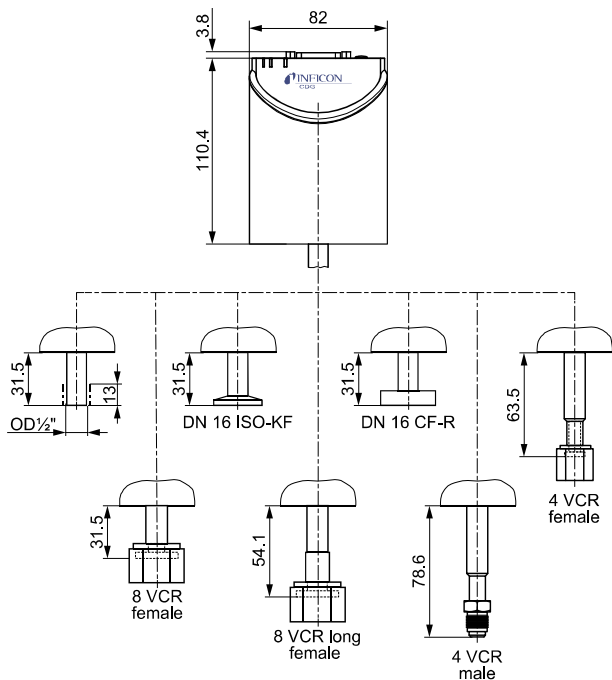

Weight

837 ... 897 g

Analog Measurement Signal vs. Pressure

Pressure p

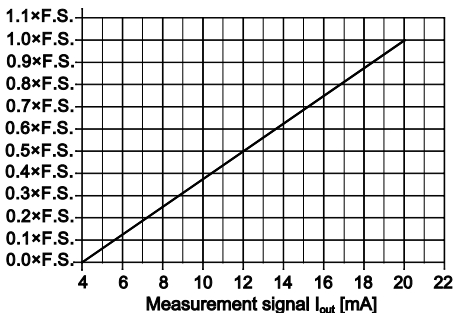

$$p = [(I_{out} - 4 \text{ mA}) / 16 \text{ mA}] \times p \text{ (F.S.)}$$

Conversion Torr \leftrightarrow Pascal

	Torr	mbar ⁴⁾	Pa ⁴⁾
c	1.00	1013.25 / 760 = 1.3332...	101325 / 760 = 133.3224...

Example: Gauge with 10 Torr F.S.
Measurement signal $I_{out} = 12 \text{ mA}$

$$p = [(12 \text{ mA} - 4 \text{ mA}) / 16 \text{ mA}] \times 10 \text{ Torr} \\ = 0.5 \times 10 \text{ Torr} = \mathbf{5 \text{ Torr}}$$

⁴⁾ Source: NPL (National Physical Laboratory)
Guide to the Measurement of Pressure and Vacuum, ISBN 0904457x/
1998

3 Installation



WARNING



Fragile components

The ceramic sensor may be damaged by impacts.

Do not drop the product and prevent shocks and impacts.

3.1 Vacuum Connection



DANGER



Overpressure in the vacuum system >1 bar

Injury caused by released parts and harm caused by escaping process gases can result if clamps are opened while the vacuum system is pressurized.

Do not open any clamps while the vacuum system is pressurized. Use the type clamps which are suited to overpressure.



DANGER



Overpressure in the vacuum system >2.5 bar

KF flange connections with elastomer seals (e.g. O-rings) cannot withstand such pressures. Process media can thus leak and possibly damage your health.

Use O-rings provided with an outer centering ring.

**DANGER****Protective ground**

Products that are not correctly connected to ground can be extremely hazardous in the event of a fault.

Electrically connect the gauge to the grounded vacuum chamber. This connection must conform to the requirements of a protective connection according to EN 61010:

- CF and VCR flanges fulfill this requirement.
- For gauges with a KF flange, use a conductive metallic clamping ring.
- For gauges with a 1/2" tube, take appropriate measures to fulfill this requirement.

**Caution****Vacuum component**

Dirt and damages impair the function of the vacuum component.

When handling vacuum components, take appropriate measures to ensure cleanliness and prevent damages.

**Caution****Dirt sensitive area**

Touching the product or parts thereof with bare hands increases the desorption rate.

Always wear clean, lint-free gloves and use clean tools when working in this area.

-  Mount the gauge so that no vibrations occur. The gauge may be mounted in any orientation. To keep condensates and particles from getting into the measuring chamber preferably choose a horizontal to upright position. If adjustment should be possible after the gauge has been installed, be sure to install it so that the buttons can be accessed with a pin (→ 22).

- 1** Remove the protective lid and connect the product to the vacuum system.

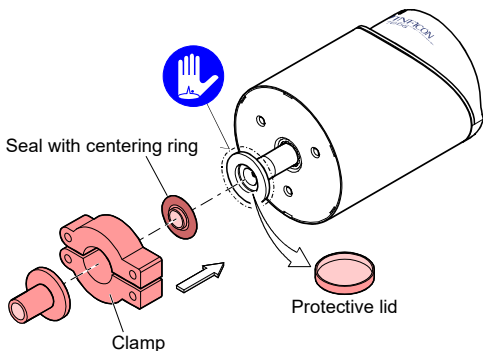

Keep the protective lid.

- 2** Mount the insulation shell.

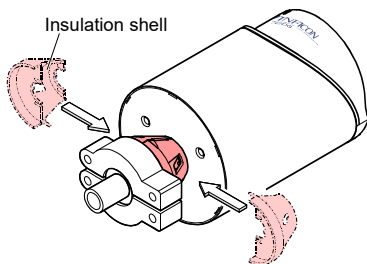

3.2 Power Connection



Make sure the vacuum connection is properly made (→ 15).

STOP**DANGER**



The gauge may only be connected to power supplies, instruments or control devices that conform to the requirements of a grounded protective extra-low voltage and limited power source (LPS), Class 2. The connection to the gauge has to be fused.

Ground loops, differences of potential, or EMC problems may affect the measurement signal. For optimum signal quality, please do observe the following notes:

- Typically connect the cable shield to ground at one side via the connector case. Make sure the connector case has direct contact to the cable's shield on its whole circumference. Do not connect the other side of the shield.
- Connect the supply common with protective ground directly at the power supply.
- Depending on the situation, following measures can cause better signal quality:
 - connect the cable shield to ground on power supply side, or
 - connect the cable shield to ground on both sides.
- Potential difference between supply common and housing ≤ 18 V (overvoltage protection).

If no sensor cable is available, make one according to the following diagram (cable length and conductor cross-sections → 11).

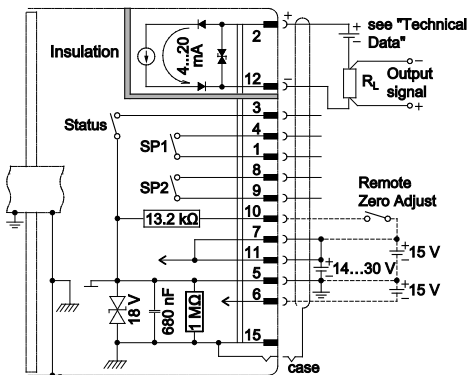

Pin 1,4	Relay SP1, closing contact
Pin 2	Positive Excitation
Pin 3	Status
Pin 5	Supply common CDG
Pin 6	Supply CDG (-15 V)
Pin 7, 11	Supply CDG (+14 ... +30 V or +15 V)
Pin 8, 9	Relay SP2, closing contact
Pin 10	Gauge identification or Remote Zero Adjust
Pin 12	Negative Excitation
Pin 15	Housing (Chassis Ground)
case	Connector case
R _L	→ 9

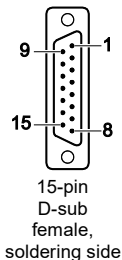

4 Operation

Put the gauge into operation.

A warm-up time of at least 90 minutes should be allowed; for precise pressure measurements a warm-up time of at least 3 hours is required.

4.1 Status Indication

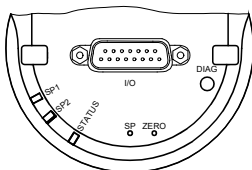

LED	LED status	Meaning
<STATUS>	off	no supply voltage
	lit solid green	measurement mode
	blinking green	warning, over/underrange
	short blinks long blinks	warming up
<SP1>	lit solid red	error
	lit green green	$p \leq$ setpoint 1
	blinking green	waiting for setpoint 1 input
<SP2>	off	$p >$ setpoint 1
	lit solid green	$p \leq$ setpoint 2
	blinking green	waiting for setpoint 2 input
	off	$p >$ setpoint 2

4.2 Zeroing the Gauge

The gauge is factory calibrated while "standing upright" (→ "Calibration Test Report").



We recommend performing a zero adjustment, when the gauge is operated for the first time.

Due to long time operation or contamination, a zero drift could occur and zero adjustment may become necessary.

For adjusting the zero, operate the gauge under the same constant ambient conditions and in the same mounting orientation as normally.

The output signal (measuring signal) is depending on the mounting orientation. The signal difference between the vertical and horizontal mounting orientation is:

F.S.	$\Delta U / 90^\circ$
1000 Torr/mbar	≈ 0.02 F.S.
100 Torr/mbar	≈ 0.1 F.S.
10 Torr/mbar	≈ 0.5 F.S.
1 Torr/mbar	$\approx 3\%$ F.S.
0.1 Torr/mbar	$\approx 18\%$ F.S.

4.2.1 <ZERO> Adjustment



The zero can be adjusted via

- the <ZERO> button on the gauge,
- the diagnostic port,
- the digital input "Remote Zero": Apply the supply voltage to pin 10, pulse →  10,



While the gauge is being heated and/or under atmospheric pressure, the zeroing function is locked in order for operating errors to be prevented.

- 1** Evacuate the gauge to a pressure according to the table below:

F.S.	Recommended final pressure for zero adjustment		
1100 mbar	–	$<7 \times 10^0$ Pa	$<7 \times 10^{-2}$ mbar
1000 Torr	$<5 \times 10^{-2}$ Torr	$<7 \times 10^0$ Pa	–
500 Torr/mbar	$<3 \times 10^{-2}$ Torr	$<4 \times 10^0$ Pa	$<4 \times 10^{-2}$ mbar
200 Torr/mbar	$<10^{-2}$ Torr	$<2 \times 10^0$ Pa	$<2 \times 10^{-2}$ mbar
100 Torr/mbar	$<5 \times 10^{-3}$ Torr	$<7 \times 10^{-1}$ Pa	$<7 \times 10^{-3}$ mbar
50 Torr/mbar	$<3 \times 10^{-3}$ Torr	$<4 \times 10^{-1}$ Pa	$<4 \times 10^{-3}$ mbar
20 Torr/mbar	$<10^{-3}$ Torr	$<2 \times 10^{-1}$ Pa	$<2 \times 10^{-3}$ mbar
10 Torr/mbar	$<5 \times 10^{-4}$ Torr	$<7 \times 10^{-2}$ Pa	$<7 \times 10^{-4}$ mbar
5 Torr/mbar	$<3 \times 10^{-4}$ Torr	$<4 \times 10^{-2}$ Pa	$<4 \times 10^{-4}$ mbar
2 Torr/mbar	$<10^{-4}$ Torr	$<2 \times 10^{-2}$ Pa	$<2 \times 10^{-4}$ mbar
1 Torr/mbar	$<5 \times 10^{-5}$ Torr	$<7 \times 10^{-3}$ Pa	$<7 \times 10^{-5}$ mbar
0.5 Torr/mbar	$<3 \times 10^{-5}$ Torr	$<4 \times 10^{-3}$ Pa	$<4 \times 10^{-5}$ mbar
0.25 Torr/mbar	$<10^{-5}$ Torr	$<2 \times 10^{-3}$ Pa	$<2 \times 10^{-5}$ mbar
0.1 Torr/mbar	$<5 \times 10^{-6}$ Torr	$<7 \times 10^{-4}$ Pa	$<7 \times 10^{-6}$ mbar

If the final pressure is too high for zero adjustment ($>25\%$ of the F.S.), the zero cannot be reached and the <STATUS> LED blinks green. If this is the case, activate the factory setting and adjust the zero again (\rightarrow  29).

- 2** Operate the gauge for at least 90 minutes (until the signal is stable).
- 3** Briefly press the <ZERO> button with a pin (max. $\varnothing 1.1$ mm), or ...

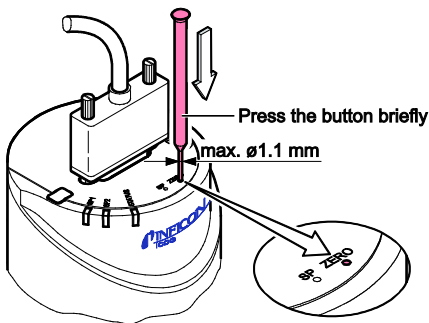

... apply supply voltage to Remote Zero at pin 10 (pulse → 10).

The zero adjustment runs automatically. The <STATUS> indicator flashes until the adjustment (duration ≈ 8 s) is completed.



After zero adjustment, the gauge automatically returns to the measurement mode.

The <STATUS> LED blinks green if

- the signal output is negative (< -20 mV) when the final pressure has been attained
- the zero adjustment has failed.

4.2.2 <ZERO> Adjustment with Ramp Function

The ramp function allows to adjust the zero at a known reference pressure within the measurement range of the gauge.

It also permits to adjust an offset of the characteristic curve in order to

- compensate for the offset of the measuring system or
- obtain a slightly positive zero for a 0 ... 10 V AD converter.

The offset should not exceed 2% of the F.S. (+200 mV). At a higher positive offset, the upper limit of the measurement range is exceeded.



Zero adjustment using the ramp function can be performed via

- the <ZERO> button on the gauge,
- the diagnostic port.

1

Operate the gauge for at least 90 minutes (until the signal is stable).

2

Push the <ZERO> button with a pin (max. $\varnothing 1.1$ mm) and keep it depressed. The <STATUS> LED starts blinking. After 5 s, the zero adjustment value, starting at the current output value, keeps continually changing (ramp) until the button is released or until the setting limit (max. 25% F.S.) is reached. The corresponding output signal is delayed by about 1 s.

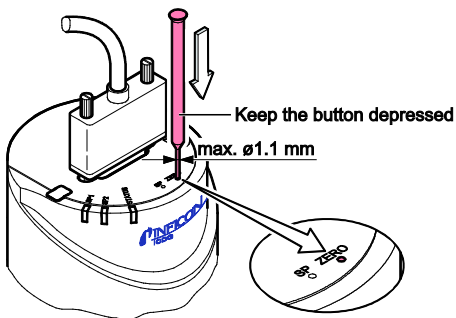

- Change of direction (inverse ramp): Release the button. Press and keep it depressed again within 3 ... 5 s (the flashing frequency of the <STATUS> indicator changes briefly).
- Fine adjustment: Release the button. Briefly press it again within 0 ... 3 s. The zero adjustment value changes by one unit (push <ZERO> button in intervals of 1 s).



If the <ZERO> button is released for more than 5 s, the gauge returns to the measurement mode.

The <STATUS> LED blinks green if the signal output is negative (< -20 mV).

4.3 Switching Functions

The two switching functions can be set to any pressure within the measurement range of the gauge (→ 14).

The current setpoint setting

- can be read/written via the diagnostic port, or
- is output at the D-sub connector instead of the measurement signal (→ 20) after the <SP> button is pressed.

If the pressure is lower than the setpoint, the corresponding LED (<SP1> or <SP2>) is lit solid and the corresponding relay (→ 20) is energized.

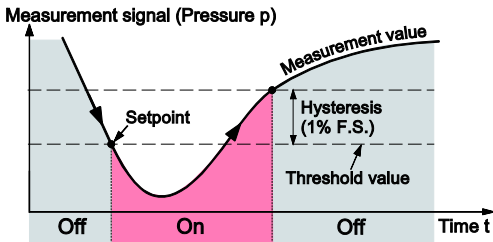

4.3.1 Adjusting the Setpoints



The setpoints can be adjusted via

- the buttons on the gauge,
- the diagnostic port.



DANGER



Malfunction

If processes are controlled via the signal output, keep in mind that by pushing the <SP> button the measurement signal is suppressed and the corresponding threshold value is output instead. This can cause malfunctions.

Push the <SP> button only if you are sure that no malfunction cause.

Adjusting Setpoint <1>

1

Push the <SP> button with a pin (max. $\varnothing 1.1$ mm). The gauge changes to the switching function mode and outputs the current threshold value at the measurement value output for about 10 s (LED <1> blinks).

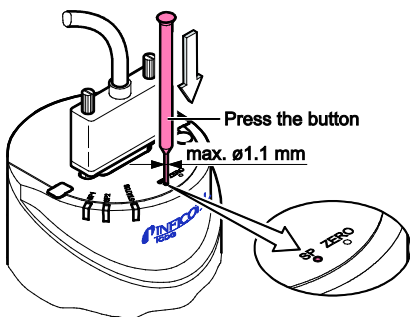

- 2** For changing the threshold value, push the <ZERO> button and keep it depressed. The threshold keeps changing from the current value (ramp) until the button is released or until the limit of the setting range is reached.

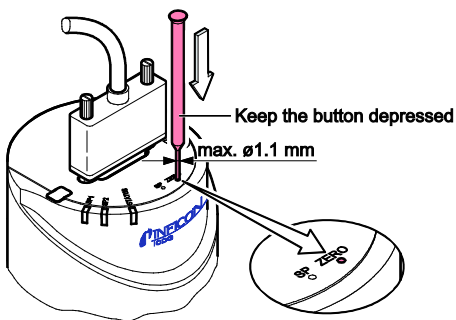

- Change of direction (inverse ramp): Release the button. Press and keep it depressed again within 3 ... 5 s (the flashing frequency of the <STATUS> indicator changes briefly).
- Fine adjustment: Release the button. Briefly press it again within 0 ... 3 s. The threshold value changes by one unit.



If the <ZERO> button is released for more than 5 s, the gauge returns the measurement mode.



The upper threshold is automatically set 1% F.S. above the lower one (hysteresis).

Adjusting Setpoint <2>

Push the <SP> button twice (the LED <2> blinks). The adjustment procedure is the same as for setpoint <1>.

4.4 Activating the Factory Setting (Factory Reset)

All user defined parameters (e.g. zero, filter) are restored to their default values.



Loading of the default parameters is irreversible.

Loading the default parameters:

- 1 Put the gauge out of operation.
- 2 Keep the <ZERO> button depressed for at least 5 s while the gauge is being put into operation (Power ON).

4.5 Diagnostic Port (RS232C Interface)

The diagnostic port <DIAG> permits to output the pressure reading and all status information and to enter all settings at the same time.

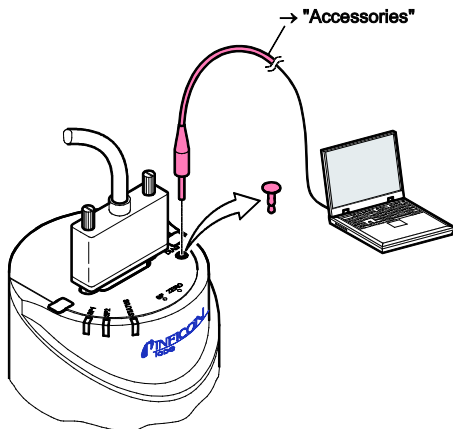

5 Deinstallation



Preconditions:



- Vacuum system vented
- Vacuum system cooled to $<50\text{ }^{\circ}\text{C}$

5.1 Power Connection

- 1 Put the gauge out of operation.
- 2 Unfasten the lock screws and disconnect the sensor cable.

5.2 Vacuum connection

	 DANGER
	<p>Hot surface</p> <p>Touching the hot surface ($>50\text{ }^{\circ}\text{C}$) can cause burns.</p> <p>Put the product out of operation and allow it to cool down.</p>

	 WARNING
	<p>Fragile components</p> <p>The ceramic sensor may be damaged by impacts.</p> <p>Do not drop the product and prevent shocks and impacts.</p>

**DANGER****Contaminated parts**

Contaminated parts can be detrimental to health and environment.

Before beginning to work, find out whether any parts are contaminated. Adhere to the relevant regulations and take the necessary precautions when handling contaminated parts.

**Caution****Vacuum component**

Dirt and damages impair the function of the vacuum component.

When handling vacuum components, take appropriate measures to ensure cleanliness and prevent damages.

**Caution****Dirt sensitive area**

Touching the product or parts thereof with bare hands increases the desorption rate.

Always wear clean, lint-free gloves and use clean tools when working in this area.

- 1 Remove the insulation shell.

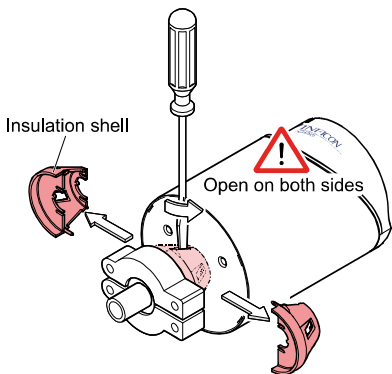

- 2 Remove the gauge from the vacuum system and install the protective lid.

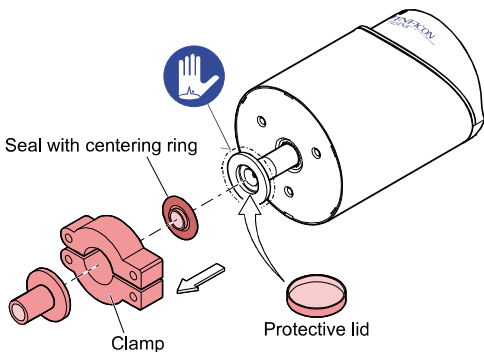

6 Maintenance, Repair

Under clean operating conditions, the product requires no maintenance.



Gauge failures due to contamination are not covered by the warranty.

We recommend checking the zero at regular intervals (→ 22).

INFICON assumes no liability and the warranty becomes null and void if any repair work is carried out by the end-user or third parties.

7 Returning the Product



WARNING



Forwarding contaminated products

Contaminated products (e.g. radioactive, toxic, caustic or microbiological hazard) can be detrimental to health and environment.

Products returned to INFICON should preferably be free of harmful substances. Adhere to the forwarding regulations of all involved countries and forwarding companies and enclose a duly completed declaration of contamination ¹⁾.

¹⁾ Form under www.inficon.com

Products that are not clearly declared as "free of harmful substances" are decontaminated at the expense of the customer.

Products not accompanied by a duly completed declaration of contamination are returned to the sender at his own expense.

8 Disposal



DANGER



Contaminated parts

Contaminated parts can be detrimental to health and environment.

Before beginning to work, find out whether any parts are contaminated. Adhere to the relevant regulations and take the necessary precautions when handling contaminated parts.



WARNING



Substances detrimental to the environment

Products or parts thereof (mechanical and electric components, operating fluids etc.) can be detrimental to the environment.

Dispose of such substances in accordance with the relevant local regulations.

Separating the components

After disassembling the product, separate its components according to the following criteria:

- Contaminated components
Contaminated components (radioactive, toxic, caustic or biological hazard etc.) must be decontaminated in accordance with the relevant national regulations, separated according to their materials, and disposed of.
- Other components
Such components must be separated according to their materials and recycled.

9 Accessories

	Ordering number
Communication adapter (2 m) ⁵⁾	303-333

ETL Certification



ETL LISTED

The product CDG100D 4-20 mA Current Loop

- conforms to the UL Standard UL 61010-1
- is certified to the CAN/CSA Standard C22.2 No. 61010-1-12

⁵⁾ The diagnostic software (Windows NT, XP) can be downloaded from our website.

EU Declaration of Conformity



We, INFICON, hereby declare that the equipment mentioned below comply with the provisions of the following directives:

- 2014/30/EU, OJ L 96/79, 29.3.2014
(EMC Directive; directive relating to electromagnetic compatibility)
- 2011/65/EU, OJ L 174/88, 1.7.2011
(RoHS Directive; directive on the restriction of the use of certain hazardous substances in electrical and electronic equipment)

Product

Capacitance Diaphragm Gauge

CDG100D 4-20 mA Current Loop

Standards

Harmonized and international/national standards and specifications:

- EN 61000-6-2:2005 (EMC: generic immunity standard)
- EN 61000-6-3:2007 + A1:2011 (EMC: generic emission standard)
- EN 61010-1:2010 (Safety requirements for electrical equipment for measurement, control and laboratory use)
- EN 61326:2013; Group 1, Class B (EMC requirements for electrical equipment for measurement, control and laboratory use)

Manufacturer / Signatures

INFICON AG, Alte Landstraße 6, LI-9496 Balzers

27 November 2020

27 November 2020

Dr. Christian Riesch
Head of Development

Paolo De Filippo
Product Manager

Notes

Notes

Original: German tinb58d1 (2020-11)



tinb58e1



LI-9496 Balzers
Liechtenstein
Tel +423 / 388 3111
Fax +423 / 388 3700
reachus@inficon.com

www.inficon.com