

Plug-In Boards for Total Pressure Gauge Controller VGC094

PI300D / DL / DN
PE300DC9
CP300C9 / C10 / T11 / T11L
IF300A / B / C
IF300P / IF301P
IF500PN

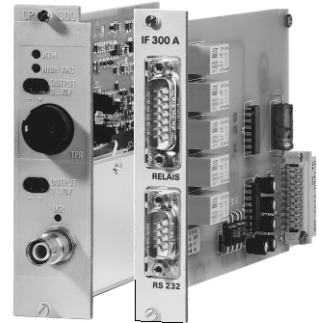

About this Document



About this document

This document describes the plug-in boards for the total pressure gauge controller VGC094, intended as a supplement to the documentation of the basic unit (→  [1]).

Validity

This document applies to plug-in boards listed below

Type	Description	Part number
PI300D	Pirani measurement board	IG 546 920-T
PI300DL	Pirani measurement board	IG 549 212-T
PI300DN	Pirani measurement board	IG 549 214-T
PE300DC9	Cold cathode measurement board	IG 441 375-T
CP300C9	Pirani/cold cathode measurement board	IG 441 000-T
CP300C10	Pirani/cold cathode measurement board	IG 441 114-T
CP300T11	Pirani/cold cathode measurement board	IG 441 080-T
CP300T11L	Pirani/cold cathode measurement board	IG 441 120-T
IF300A	Interface and relay Board (RS232C)	IG 441 130-T
IF300B	Interface and relay Board (RS232C)	IG 441 250-T
IF300C	Interface and relay Board (RS422C)	IG 441 390-T
IF300P	Interface and relay Board (PROFIBUS)	IG 441 395-T
IF301P	Interface and relay Board (PROFIBUS)	IG 441 396-T
IF500PN	Interface Board (PROFINET)	398-421



The part number (PN) can be taken from the product nameplate.

We reserve the right to make technical changes without prior notice.

Contents

About this Document	2
Validity	2
1 Safety	4
1.1 Symbols Used	4
1.2 Personnel Qualifications	5
1.3 General Safety Information	5
1.4 General Stipulations	5
1.5 Liability and Warranty	5
2 Description	6
2.1 Pirani Measurement Boards	6
2.2 Cold Cathode Measurement Boards	6
2.3 Pirani/Cold Cathode Measurement Boards	6
2.4 Interface and Relay Board	6
2.5 Pirani Measurement	7
2.6 Cold Cathode Measurement	7
3 Technical Data	8
3.1 Pirani Measurement Boards	8
3.2 Cold Cathode Measurement Board	9
3.3 Pirani/ Cold Cathode Measurement Boards	10
3.4 Interface and Relay Boards	11
4 Installation	14
4.1 Installing / Removing the Plug-In Boards	15
4.2 Connecting the Pirani Gauge	16
4.3 Connecting the Cold Cathode Gauge	16
4.4 Connecting the <OUTPUT> Analog Signal	18
4.5 Connecting the <CONTROL> Analog Signals	18
4.6 Connecting the Relays of the IF300A	20
4.7 Connecting the Relays of the IF300B	20
4.8 Connecting the Relays of the IF300C	22
4.9 Connecting the Relays of the IF30xP	22
4.10 Connecting the RS232C Interface to the IF300A	23
4.11 Connecting the RS232C Interface to the IF300B	24
4.12 Connecting the RS422 Interface to the IF300C	25
4.13 Connecting the PROFIBUS-DP Interface to the IF30xP	26
4.14 Connecting the PROFINET Interface to the IF500PN	27
5 Adjustment	28
5.1 Adjusting the Pirani Measurement Circuit	28
6 Troubleshooting	29
6.1 Installation Problems	29

6.2	Operating and Adjustment Problems	29
6.3	Defects	30
6.4	Problems with the RS232C Interface	30
6.5	Problems with the RS422 Interface	30
6.6	Problems with the PROFIBUS-DP Interface	31
7	Accessories	32
7.1	Pirani Gauges	32
7.2	Cold Cathode Gauges	32
7.3	Measurement Cables	33
7.4	Accessories for Plug-In Boards	34
	Appendix	35
A:	Output Signals of the Measurement Boards	35
B:	Gas Type Dependence	37
C:	Literature	39

For cross-references within this document, the symbol (→  XY) is used, for cross-references to further documents listed under "Literature", the symbol (→  [Z]).

1 Safety

1.1 Symbols Used



Information on preventing any kind of physical injury.



Information on preventing extensive equipment and environmental damage.



Information on correct handling or use. Disregard can lead to malfunctions or minor equipment damage.



<.....> Labeling

1.2 Personnel Qualifications



Skilled personnel

All work described in this document may only be carried out by persons who have suitable technical training and the necessary experience or who have been instructed by the end-user of the product.

1.3 General Safety Information

- Take the necessary precautions when doing installation work.
It may be necessary implement additional protective measures in the system.
- Before connecting any external elements, check that they are compatible with the technical data in this document.
- Take the necessary precautions when doing maintenance or repair work.

Communicate the safety instructions to all other users.

1.4 General Stipulations

Since the individual components are delicate, appropriate measures must be taken to protect them from static electricity. Store modules in antistatic bags or containers.

Damage resulting from incorrect handling may lead to a revocation of the guarantee.

1.5 Liability and Warranty

INFICON assumes no liability and the warranty becomes null and void if the end-user or third parties

- disregard the information in this document
- use the product in a non-conforming manner
- make any kind of interventions (modifications, alterations etc.) on the product
- use the product with accessories, spare parts and consumables not listed

2 Description

2.1 Pirani Measurement Boards

Pirani boards have two independent medium vacuum measurement circuits, each with one gauge cable connector, two trimmer potentiometers and one analog signal output. When the control unit is on, the Pirani measurement circuits are in continuous operation. The analog signals are constantly available, independent of what is shown on the pressure display.

2.2 Cold Cathode Measurement Boards

Cold cathode measurement boards for the measurement of high and ultra high vacuum contain one or two measurement circuits, each with one gauge cable connector and one analog signal output. When the gauge is turned on, the analog signals are constantly available, independent of what is shown on the pressure display.

This measurement board contains special electronics to limit the measurement current to 100 μA , a feature that considerably extends the lifetime of the gauge.

2.3 Pirani/Cold Cathode Measurement Boards

As the name indicates, these are combined boards containing one Pirani and one cold cathode measurement circuit each. They have the same characteristics as the boards described above.

Measurement boards for the range of 10^{-10} and 10^{-11} mbar contain special electronics to limit the measurement current to 100 μA , a feature that considerably extends the lifetime of the gauge.

2.4 Interface and Relay Board

Five types of interface and relay boards are available: Two contain an RS232C interface, one an RS422 and two an PROFIBUS-DP interface. All five types have five relays with one floating changeover contact each. The main difference between these five boards is the switching voltage of the relays and the type of interface port.

2.5 Pirani Measurement

Within certain limits the thermal conductivity of gases is a function of the pressure. Pirani thermal conductivity vacuum gauges exploit this phenomenon for pressure measurements.

The measurement element consists of a thin filament with a high temperature coefficient. The resistance of the wire and consequently its temperature are maintained at a constant value by means of a suitable control circuit. The electrical power supplied to the filament is, therefore, a measure of the thermal conductivity and consequently the gas pressure.

2.6 Cold Cathode Measurement

The current flowing in a self-sustained gas discharge with a cold cathode (similar to Penning) depends on the applied voltage, the gas composition, and the pressure. A magnetic field that penetrates the measurement chamber has the effect that the electrons move along a spiral trajectory from the cathode to the anode and thereby cause even at low gas densities a sufficient number of ionizing impacts for maintaining the discharge. If (with a known gas type) the anode voltage and magnetic field are kept constant, the discharge current is a measure of the pressure.

3 Technical Data

3.1 Pirani Measurement Boards

		PI300D for Pirani gauges with tungsten filament	PI300DL for Pirani gauges with tungsten filament	PI300DN for Pirani gauges with nickel filament
Number of measurement circuits		2	2	2
Measurement range ¹⁾ from 1000 mbar ... mbar		8×10^{-4}	8×10^{-4}	8×10^{-4}
Cable length, max. m		100	500	100
Signal output				
Measured value, analog	V	0 ... +10	0 ... +10	0 ... +10
Error message	V	>11.5	>11.5	>11.5
Current, max.	mA	2	2	2
Output resistance	Ω	400	400	400
Reaction time (10 \Rightarrow 90%) for sudden pressure step				
<10 ⁻³ \Rightarrow 10 ³ mbar	ms	<50	<50	<50
10 ³ \Rightarrow <10 ⁻³ mbar	ms	<600	<600	<600
Connection, (equipment side)				
MAG gauge	Female	Amphenol C91E 6 pin \varnothing 2 mm	Amphenol C91E 6 pin \varnothing 2 mm	Amphenol C91E 6 pin \varnothing 2 mm
Signal output	Female			
Weight	kg	\approx 0.14	\approx 0.14	\approx 0.14

¹⁾ N₂-equivalent

3.2 Cold Cathode Measurement Board

			PE300DC9
Number of measurement circuits			2
Measurement range ¹⁾			
from 5×10^{-3} mbar ...	mbar		1×10^{-9}
Cable length, max.		m	60 ²⁾ ... 100
Power supply for gauge			
Operating voltage	kV		3.3
Measurement current	μ A		≤ 100
Signal output			
Measured value, analog	V		0 ... +10
Error message	V		>11.5
Current, max.	mA		2
Output resistance	Ω		400
Reaction time (10 \Rightarrow 90%) for sudden pressure step			
$< 10^{-9} \Leftrightarrow 10^{-3}$ mbar	ms		< 20
Connection, equipment side			
Cold cathode gauge	Female		SHV coaxial
Signal output	Female		$\varnothing 2$ mm
Weight		kg	≈ 0.26

¹⁾ N₂-equivalent

²⁾ when using the lower measurement range limit (\rightarrow  16)

3.3 Pirani/ Cold Cathode Measurement Boards

		CP300C9	CP300C10	CP300T11	CP300T11L
Number of measurement circuits		1 each	1 each	1 each	1 each
Measurement range ¹⁾					
Pirani: from 1000 mbar ...	mbar	8×10^{-4}	8×10^{-4}	8×10^{-4}	8×10^{-4}
Cold cathode: from 5×10^{-3} mbar ...	mbar	5×10^{-9}	1×10^{-10}	1×10^{-11}	1×10^{-11}
Cable length					
Pirani, max.	m	100	100	100	500
Cold cathode, max.	m	60 ²⁾ ... 100	60 ²⁾ ... 100	500	500
Power supply					
Cold cathode gauges					
Operating voltage	kV	3.3	3.3	3.3	3.3
Measurement current	μ A	≤ 600	≤ 100	≤ 100	≤ 100
Signal output					
Measured value, analog	V	0 ... +10	0 ... +10	0 ... +10	0 ... +10
Error message	V	>11.5	>11.5	>11.5	>11.5
Current, max.	mA	2	2	2	2
Output resistance	Ω	400	400	400	400
Reaction time (10 \Rightarrow 90%) for sudden pressure step					
Pirani < 10^{-3} \Rightarrow 10^3 mbar	ms	<50	<50	<50	<50
10^3 \Rightarrow < 10^{-3} mbar	ms	<600	<600	<600	<600
Cold cathode 10^{-9} \Leftrightarrow 10^{-3} mbar	ms	<10	<50	<50	<50
Connection, equipment side					
Pirani gauge	Female	Amphenol C91E 6 pin	Amphenol C91E 6 pin	Amphenol C91E 6 pin	Amphenol C91E 6 pin
Cold cathode gauge	Female	SHV coaxial	SHV coaxial	triaxial	triaxial
Signal output	Female	$\varnothing 2$ mm	$\varnothing 2$ mm	$\varnothing 2$ mm	$\varnothing 2$ mm
Weight	kg	≈ 0.21	≈ 0.23	≈ 0.25	≈ 0.25

¹⁾ N₂-equivalent

²⁾ when using the lower measurement range limit (\rightarrow  16)

3.4 Interface and Relay Boards

	IF300A	IF300B
Relay		
Number	5 (mechanical relays)	5 (mechanical relays)
Contact type	1 change over contact each floating	1 change over contact each floating
Characteristic data (ac)		
Switching voltage, max.	50 V (ac)	250 V (ac)
Switching current, max.	1.5 A	4 A
Switching power, max.	75 VA	1000 VA
Characteristic data (dc)		
Switching voltage, max.	50 V (dc)	200 V (dc)
Switching current, max.	0.6 A at 50 V (dc) 0.8 A at 40 V (dc) 1.5 A at 30 V (dc)	0.25 A at 200 V (dc) 0.3 A at 140 V (dc) 0.4 A at 100 V (dc) 0.5 A at 60 V (dc) 0.6 A at 50 V (dc) 0.8 A at 40 V (dc) 4.0 A at 30 V (dc)
Switching power, max.	45 W	120 W
Connection, equipment side		
Type	D-sub connector, 15-pin, male	GdsA-H, DIN 41 612 15-pin, male
Transition resistance with socket	125 mΩ	70 mΩ
Serial interface		
Type	RS232C, asynchronous	RS232C, asynchronous
Baud rates	300, 1200, 2400, 4800, 9600	300, 1200, 2400, 4800, 9600
Data format	ASCII 1 start bit, 8 data bits, 1 stop bit, no parity bit	ASCII 1 start bit, 8 data bits, 1 stop bit, no parity bit
Connection, equipment side	D-sub connector, 9-pin, male	0.4 m cable with D-sub connector, 25 pin, male
Cable length, max.	30 m	30 m
Fieldbus interface	none	none
Weight	≈0.14 kg	≈0.15 kg



Before connecting any external elements, check that they conform to the above technical data.

	IF300C	IF300P
Relay		
Number	5 (mechanical relays)	5 (mechanical relays)
Contact type	1 change over contact each floating	1 change over contact each floating
Characteristic data (ac)		
Switching voltage, max.	50 V (ac)	50 V (ac)
Switching current, max.	1.5 A	1.5 A
Switching power, max.	75 VA	75 VA
Characteristic data (dc)		
Switching voltage, max.	50 V (dc)	50 V (dc)
Switching current, max.	0.6 A at 50 V (dc) 0.8 A at 40 V (dc) 1.5 A at 30 V (dc)	0.6 A at 50 V (dc) 0.8 A at 40 V (dc) 1.5 A at 30 V (dc)
Switching power, max.	45 W	45 W
Connection, equipment side		
Type	D-sub connector, 15-pin, male	D-sub connector, 15-pin, male
Transition resistance with socket	125 mΩ	125 mΩ
Serial interface		
Type	RS-422, asynchronous	
Baud rates	300, 1200, 2400, 4800, 9600	
Data format	ASCII 1 start bit, 8 data bits, 1 stop bit, no parity bit	
Connection, equipment side	D-sub connector, 9-pin, female	
Cable length, max.	1200 m	
Fieldbus interface	none	
Type		PROFIBUS-DP ¹⁾
Baud rates		<12Mbaud ¹⁾
Connection, equipment side		D-sub connector, 9-pin, female
Weight	≈0.14 kg	≈0.16 kg

¹⁾ Detailed information on the PROFIBUS-DP Interface can be found in the communication protocol (→  [3]).



Before connecting any external elements, check that they conform to the above technical data.

	IF301P	IF500PN
Relay		
Number	5 (solid state relays)	
Contact type	1 change over contact each floating	
Characteristic data (ac)		
Switching voltage, max.	50 V (ac)	
Switching current, max.	0.5 A	
Switching power, max.	25 VA	
Characteristic data (dc)		
Switching current, max.	30 V (dc)	
Switching current, max.	0.5 A at 30 V (dc)	
Switching power, max.	15 W	
Connection, equipment side		
Type	D-sub connector, 15-pin, male	
Transition resistance with socket	2.5 Ω	
Serial interface		
Type		
Baud rates		
Data format		
Connection, equipment side		
Cable length, max.		
Fieldbus interface		
Type	PROFIBUS-DP ¹⁾	PROFINET ²⁾
Baud rates	<12Mbaud ¹⁾	100 Mbits/s
Connection, equipment side	D-sub connector, 9-pin, female	2×RJ45
Weight	≈0.16 kg	≈0.16 kg

¹⁾ Detailed information on the PROFIBUS-DP Interface can be found in the communication protocol (→  [3]).

²⁾ Detailed information on the PROFINET Interface can be found in the communication protocol (→  [2]).



Before connecting any external elements, check that they conform to the above technical data.

4 Installation

General







Use screened cables only (connect screen to barrel of connector). If both ends of the screen are connected to ground, compensating currents must be prevented (e.g. by connecting all involved units to a common power distributor). In a PROFIBUS-DP installation (IF30xP board), use the recommended special cable only (→  [3]).





Installing/Removing the Plug-In Boards

Description →  15

Connecting the Relays of the Interface and Relay Boards

Type	Description
IF300A	→  20
IF300B	→  20
IF300C	→  22
IF30xP	→  22

Connecting the Interfaces

Type	Description			
	RS232	RS422	PROFIBUS-DP	PROFINET
IF300A	→  23	–	–	–
IF300B	→  24	–	–	–
IF300C	–	→  25	–	–
IF30xP	–	–	→  26	–
IF500PN	–	–	–	→  27

Installing the Measurement Boards

Installing/removing plug-in boards
 Connecting the Pirani gauge
 Connecting the cold cathode gauge
 Connecting the analog signal

Board type	→ 			
PI300D PI300DL PI300DN	15	16	–	18
PE300DC9	15	–	16	18
CP300C9 CP300C10	15	16	16	18
CP300T11 CP300T11L	15	16	16	18

4.1 Installing / Removing the Plug-In Boards



For safety reasons, vacant slots should always be covered with blank panels.

Disconnect all cables from the unit before installing/removing any plug-in modules.



Modules should only be handled on an ESD protected bench.

Procedure

- Switch off the unit and wait one minute
- Remove all cables (power cable last)
- Unscrew the blind plate / plug-in module
- Insert / remove plug-in module
- Screw on the plug-in module / blind plate
- Connect the cables (mains cable first)
- Switch on the unit again



To ensure correct operation, check that the screws of the plug-in modules are tightened.

4.2 Connecting the Pirani Gauge



Additional protective measures must be taken if certain processes in the vacuum system (e.g. flashovers) can cause hazardous voltages on the gauge terminals.



Although the gauge cables are screened, they should not be routed in parallel to lines producing strong electrical noise.

Connect the gauge to the <TPR> connector on the rear panel. The connectors are locked so that they cannot be separated accidentally.

4.3 Connecting the Cold Cathode Gauge



Additional protective measures must be taken if certain processes in the vacuum system (e.g. flashovers) can cause hazardous voltages on the gauge terminals.



Although the gauge cables are screened, they should not be routed in parallel to lines producing strong electrical noise.

Connect the gauge to the <IKR> connector. Coaxial cables normally suffice. The following diagram indicates the conditions under which a triaxial cable is required.

Pressure [hPa]

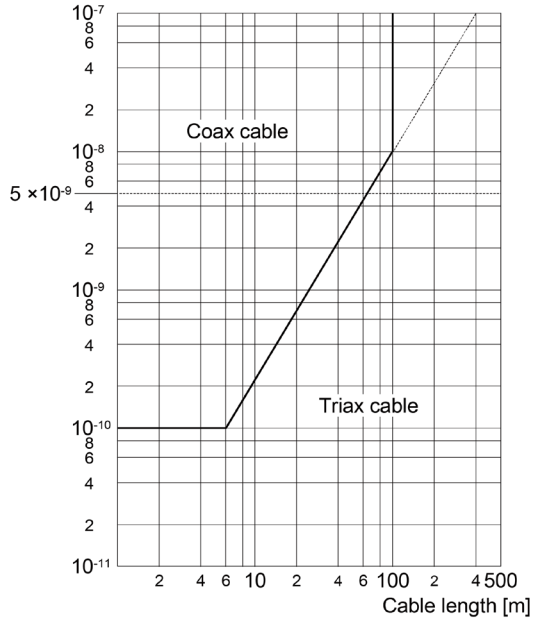

The maximum length of 100 m for coaxial cables is specified by EN 61010. Greater lengths are not admissible without additional protective measures.

If the gauge is not grounded via the vacuum chamber, it must be grounded separately.



If the cable length is >100 m (only admissible with triaxial cable), the connectors must be protected against unintentional separation and contact of the center conductor. The cable must only be plugged in or detached while the unit is switched off.

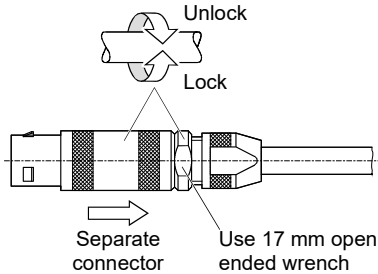

Protection against unintentional separation of the triaxial connector.

4.4 Connecting the <OUTPUT> Analog Signal

(except for PE300DC9)

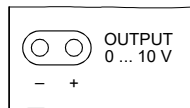

Each measurement circuit is equipped with an analog signal output. Matching connectors are included with each measurement board.

4.5 Connecting the <CONTROL> Analog Signals

(only for PE300DC9)

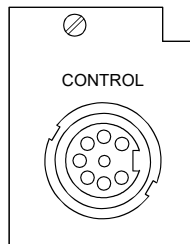

Each measurement circuit is equipped with a control input and an analog signal output. Matching connectors are included with each measurement board.

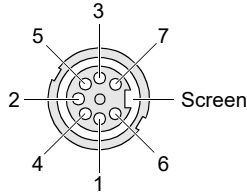

Pin assignment

Pin 1	Analog GND MAG 1
Pin 2	Digital GND
Pin 3	Analog GND
Pin 4	MAG ON 1
Pin 5	MAG ON 2
Pin 6	Analog Output
Pin 7	Analog Output
Housing	Screen

External Switching On/Off of the Measure- ment Circuit

There are various ways to switch a measurement circuit on/off:

- manually
- automatically
- externally, via a contact on the <control> connection

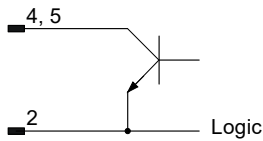
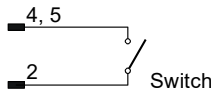

Switch on the gauge manually or automatically before initiating gauge control via an external input.

4.6 Connecting the Relays of the IF300A

The relay connector on the rear of the IF300A has the following pin assignment:

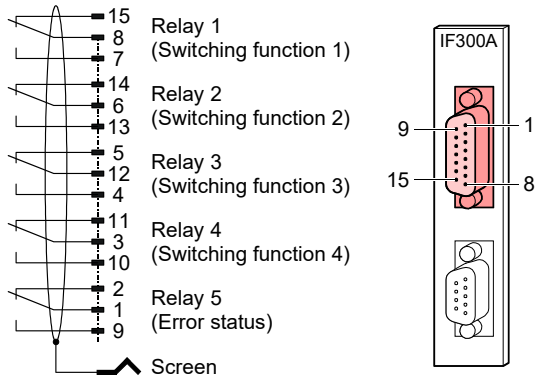

Contacts shown de-energized

Pin location

4.7 Connecting the Relays of the IF300B

The relay connector on the rear of the IF300B has the following pin assignment (no screened cables required):

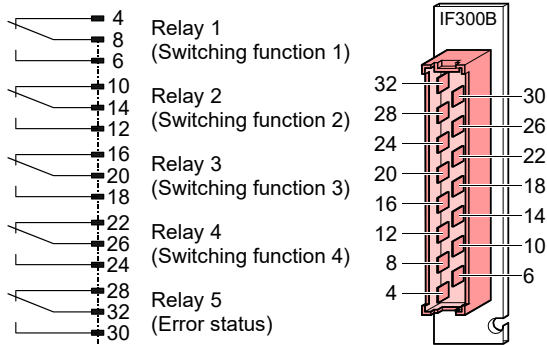

Contacts shown de-energized

Pin location



The connectors may only be wired, mounted, plugged in, and unplugged in de-energized condition.

At voltages <50 V insulated blade receptacles 4.8×0.8 mm may be used. However, also in this case we recommend the use of the relay connector because it permits fast separation of the connection as well as strain relief.

Always use the relay connector at voltages ≥ 50 V (→  34) for safety reasons.



Mount the enclosed ferrite clamp in order to reduce the electromagnetic interference.

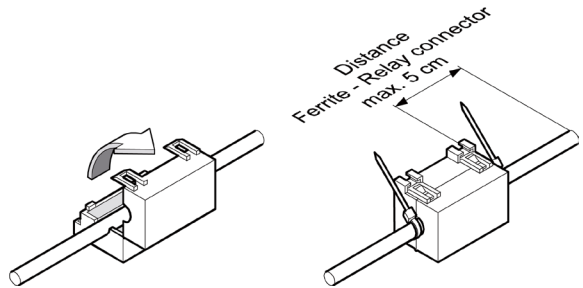

4.8 Connecting the Relays of the IF300C

The relay connector on the rear of the IF300C has the following pin assignment:

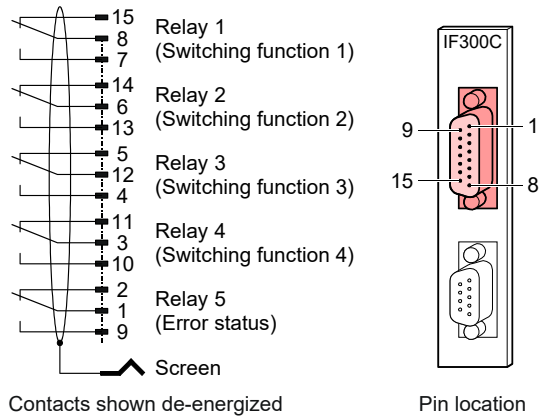

4.9 Connecting the Relays of the IF30xP

The relay connector on the rear of the IF30xP has the following pin assignment:

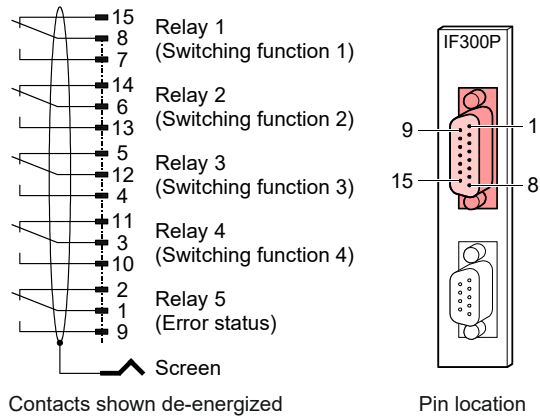

4.10 Connecting the RS232C Interface to the IF300A

The interface connector on the rear of the IF300A has the following pin assignment:

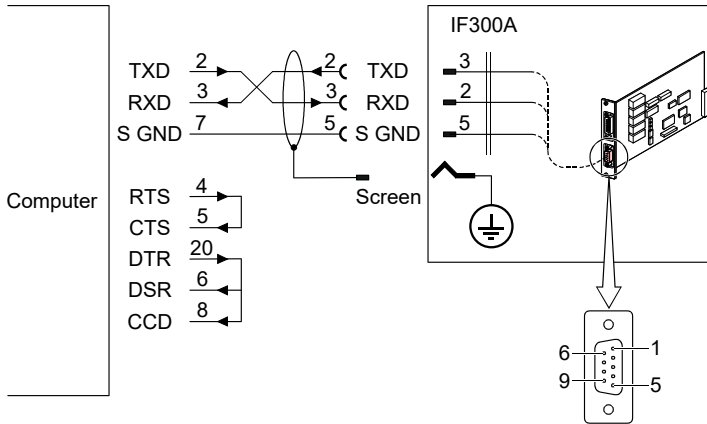

Pin 3 = Transmit data TXD *)
 Pin 2 = Receive data RXD *)
 Pin 5 = Signal gnd
 Housing = Screen

*) Reference point: IF300A

4.11 Connecting the RS232C Interface to the IF300B

Interface Cable

If you intend to use the RS232C interface, the interface cable has to be installed in the specified sequence first:

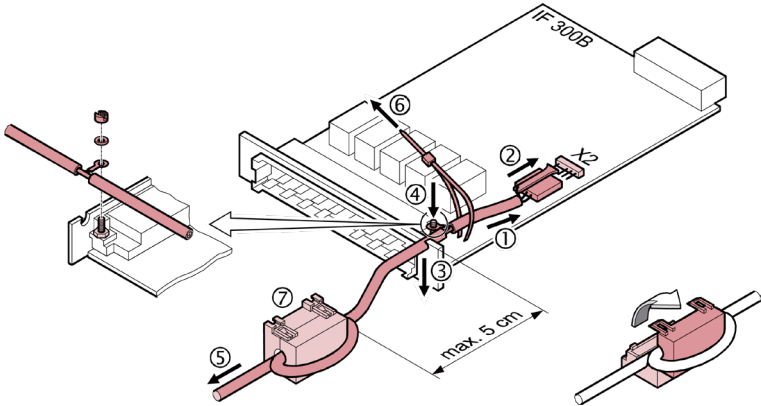

Pin Assignment

The interface connector on the rear of the IF300B has the following pin assignment:

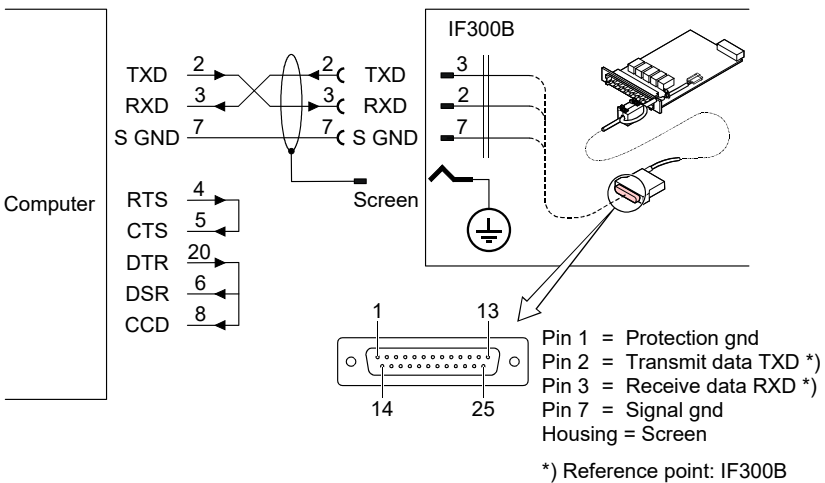

4.12 Connecting the RS422 Interface to the IF300C

The interface connector on the rear of the IF300C has the following pin assignment:

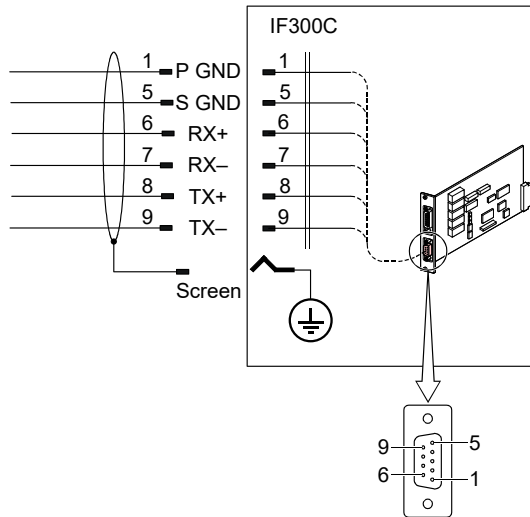

- Pin 1 = Protection gnd
- Pin 5 = Signal gnd
- Pin 6 = Receive data +
- Pin 7 = Receive data -
- Pin 8 = Transmit data +
- Pin 9 = Transmit data -
- Housing = Screen

*) Reference point: IF300C

4.13 Connecting the PROFIBUS-DP Interface to the IF30xP



In a PROFIBUS-DP installation, use the recommended special cable only (→ [3]).

The interface connector on the rear of the IF30xP has the following pin assignment:

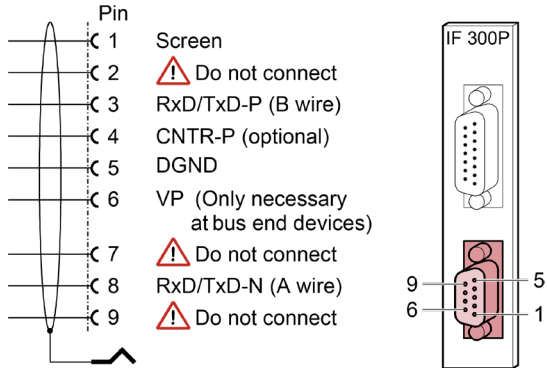

4.14 Connecting the PROFINET Interface to the IF500PN



In a PROFINET installation, use the recommended special cable only (→ [\[2\]](#)).

From the previous device the cable connected to OUT port has to be connected to the IF500PN <IN> port. And the cable from the IF500PN <OUT> port has to be connected to the next device's <IN> port.

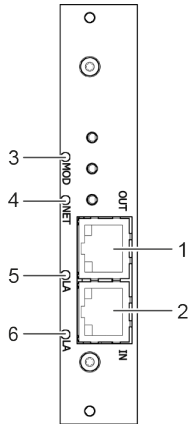

- 1 OUT – PROFINET OUT-connector
- 2 IN – PROFINET IN-connector
- 3 MOD – The MOD LED indicates the module status of the IF500PN
- 4 NET – The NET LED indicates the network status of the IF500PN
- 5 LA – Link activity PROFINET OUT
- 6 LA – Link activity PROFINET IN

The interface connectors on the rear of the IF500PN have the following pin assignment:

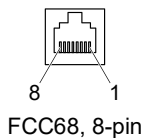

- Pin 1: TD+ Transmission Data +
- Pin 2: TD- Transmission Data -
- Pin 3: RD+ Receive Data +
- Pin 6: RD- Receive Data -
- Pin 4, 5, 7,8: not used

5 Adjustment

Pirani measurement circuits are factory-adjusted to the standard gauge. Due to manufacturing tolerances, contamination of the gauges, and different cable lengths, deviations are inevitable.

Cold cathode measurement circuits are factory-adjusted and require no readjustment.

5.1 Adjusting the Pirani Measurement Circuit

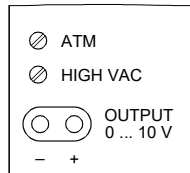

Two trimmer potentiometers are available for compensating the gauge tolerances, gauge contamination, or different cable lengths, within certain limits.



The adjustment should only be performed after the equipment has attained operating temperature (≈ 10 Minutes).

Adjustment at High Vacuum

- With gauge connected, lower the vacuum chamber pressure to $<1 \times 10^{-4}$ mbar
- Select the measurement circuit to be adjusted («sensor» mode)
- With the <HIGH VAC> potentiometer adjust the display to 8.0×10^{-4} mbar
- Turn the potentiometer clockwise by 90°
- «ur 10^{-4} » should now be displayed (\rightarrow  [1]).





Adjustment at Atmospheric Pressure

- Expose the gauge to atmospheric pressure (vent the vacuum chamber)
- Turn the <ATM> potentiometer to obtain a reading of 1.0×10^3 mbar
- Decrease the pressure to $<1 \times 10^{-4}$ mbar
- Check the high vacuum reading and readjust, if necessary.





6 Troubleshooting

In addition to the guidelines below, take the documentation of the other system components into account (→ Literature  39).





6.1 Installation Problems

Problem	Possible cause	Correction
Gauge cable cannot be connected to MAG gauge	Old MAG gauge with MHV connector	Use the correct cable (→  34)
		Change the connector (→  [5], [6])
Gauge cable cannot be connected to the measurement board	Gauge cable with old connector	Use the correct cable (→  34)
		Remove and replace connector (→  34)



6.2 Operating and Adjustment Problems

Problem	Possible cause	Correction
Pirani reading too high	Pirani gauge contaminated	Adjust Pirani measurement circuit (→  28)
		Clean gauge (→  [4])
		Replace gauge
Cold cathode reading too high	Connector insulation contaminated or moist	Clean insulation or replace connector
	Air humidity (⇒ leakage current)	Keep the air humidity low
		Keep the equipment in constant operation
Cold cathode reading too low	Cold cathode gauge contaminated	Clean gauge (→  [5], [6])
Pirani can not be adjusted	Incorrect combination measurement board — gauge — cable	Select correct combination (→  16)
	Gauge severely contaminated	Clean or replace gauge (→  [4])

6.3 Defects

Problem	Possible cause	Correction
Cold cathode constantly indicates «  » (overrange), (even though the pressure is within the measuring range)	Short circuit in the cold cathode cable / gauge	Replace or repair the cable / gauge
	Cold cathode measurement board defective	Replace the cold cathode measurement board (→  16)
Cold cathode indicates «  » (underrange), even though the pressure is within the measuring range	No MAG gauge connected	Connect the gauge
	Interruption in cold cathode cable	Replace or repair the cable
	Cold cathode gauge defective	Replace the gauge (→  [5], [6])
	Cold cathode measurement board defective	Replace the cold cathode measurement board (→  16)

6.4 Problems with the RS232C Interface

Problem	Possible cause	Correction
No communication	Pin 2 and 3 of the interface cable not crossed	Use cable according to  23, 24
	Incorrect Baud rate	Match Baud rate
	Incorrect data format	Adhere to the format specified for the VGC094 (→  [1])

6.5 Problems with the RS422 Interface







Problem	Possible cause	Correction
No communication	Incorrect Baud rate	Match Baud rate
	Incorrect data format	Adhere to the format specified for the VGC094 (→  [1])

6.6 Problems with the PROFIBUS-DP Interface



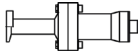

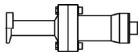

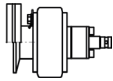

Problem	Possible cause	Correction
No communication	Incorrect Baud rate	Set Baud rate to 9600 Baud (VGC094)
	Incorrect data format	Adhere to the standardized PROFIBUS-DP data format (→  [3])

7 Accessories

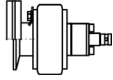
7.1 Pirani Gauges

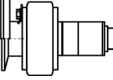
Gauge	Compatible to measurement board:	Vacuum connection	Ordering number
 PSG010 →  [4]	PI300D, PI300DL, CP300C9, CP300C10	DN 10 ISO-KF	350-400
 PSG017 →  [4]	PI300DN	DN 16 ISO-KF DN 16 CF-F	350-430 350-431
 PSG018 →  [4]	PI300D, PI300DL, CP300C9, CP300C10	DN 16 ISO-KF DN 16 CF-F DN 40 CF-F	350-420 350-424 350-423

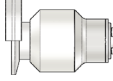
7.2 Cold Cathode Gauges

Gauge	Compatible to measurement board:	Vacuum connection	Ordering number
 MAG050 →  [5]	PE300DC9, CP300C9 CP300C10	DN 25 ISO-KF DN 40 ISO-KF DN 40 CF-F	399-840 399-841 399-842
 MAG060 →  [5]	PE300DC9, CP300C9 CP300C10	DN 40 ISO-KF DN 40 CF-F	399-845 399-846
 MAG070 →  [5]	CP300T11, CP300T11L	DN 40 ISO-KF DN 40 CF-F	399-847 399-848
 MAG084 →  [6]	CP300C9	DN 40 ISO-KF DN 40 CF-F	399-849 399-850

7.3 Measurement Cables

Pirani Measurement and Extension Cables

Length [m (ft)] ¹⁾	Pirani Measurement cables (80 °C) for: (Ordering numbers)			Measurement cables, high temperature version (250 °C) for PSG017 PSG018 ³⁾
	PSG010 ²⁾	PSG017 ³⁾	PSG018 ³⁾	
3 (9.9)	BG 548 402 -T	BG 548 308 -T	BG 548 308 -T	BG 548 414 -T
6 (19.8)	BG 548 403 -T	BG 548 309 -T	BG 548 309 -T	BG 548 465 -T
10 (33)	BG 548 450 -T	BG 548 456 -T	BG 548 456 -T	BG 448 047 -T
15 (49)	BG 548 451 -T	BG 548 457 -T	BG 548 457 -T	BG 448 043 -T

Length [m (ft)] ¹⁾	Extension cables for PSG010, PSG017, PSG018 ⁴⁾
10 (33)	BG 548 466 -T
20 (65)	BG 548 468 -T
30 (99)	BG 548 470 -T

- 1) Other lengths on request.
- 2) Pirani measurement cable for PSG010:

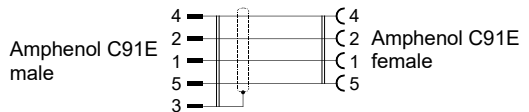

- 3) Pirani measurement cable for PSG017, PSG018:

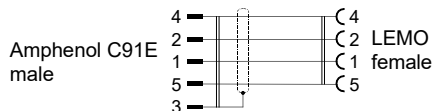

- 4) Extension cable for Pirani gauges
PSG010, PSG017 and PSG018:
Amphenol C91E male connector — C91E female
connector (1:1)

Cold Cathode Measurement Cables (Test voltage: 6 kV (dc))

Length [m (ft)] 1)	Cold cathode measurement cables (80 °C) for: (Ordering numbers)				High temperature versions (250 °C) for MAG050 / 060 / 084 2)
	MAG050 2)	MAG060 2)	MAG070 3)	MAG084 2)	
3 (9.9)	BG 548 406 -T	BG 548 406 -T	BG 548 306 -T	BG 548 406 -T	BG 548 542 -T
6 (19.8)	BG 548 407 -T	BG 548 407 -T	BG 548 317 -T	BG 548 407 -T	BG 548 543 -T
10 (33)	BG 548 419 -T	BG 548 419 -T	BG 548 490 -T	BG 548 419 -T	BG 448 045 -T
15 (49)	BG 548 483 -T	BG 548 483 -T	BG 548 491 -T	BG 548 483 -T	BG 548 989 -T

- 1) Other lengths on request.
- 2) Cold cathode measurement cable for MAG050, MAG060 and MAG084:
Coaxial cable, SHV connector
- 3) Cold cathode measurement cable for MAG070:
Triaxial cable, triaxial connector

7.4 Accessories for Plug-In Boards

		for	Ordering number
D-sub connector	15-pin, female	IF300A	IG 441 129-T
D-sub connector	9-pin, female	IF300A	IG 441 128-T
Relay connector	15-pin, DIN 41 612	IF300B	IG 546 999-T
Interface cable RS232C	0.4m	IF300B	IG 548 932-T
D-sub connector	15-pin, female	IF300C	IG 441 129-T
D-sub connector	9-pin, female	IF300C	IG 441 145-T
Connector Amphenol C91E, 7-pin (<Control>, spare part)		PE300DC9	B 4722 107CC

Appendix

A: Output Signals of the Measurement Boards

Pirani Gauges

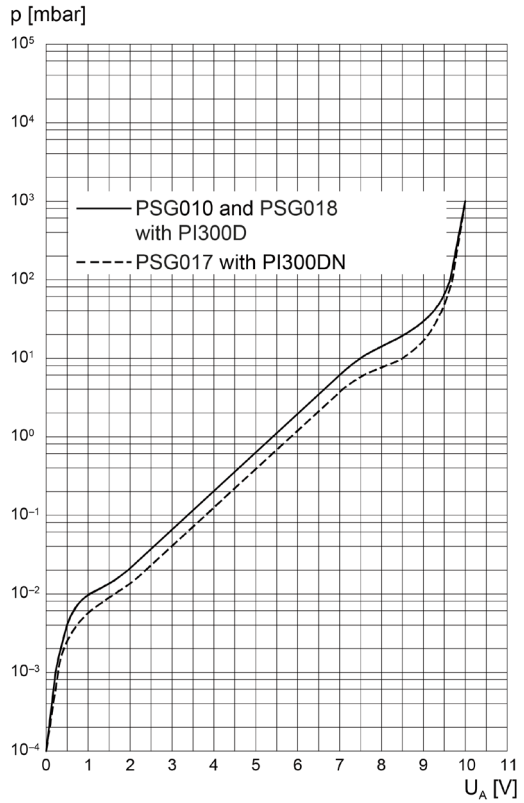

Cold Cathode Gauges

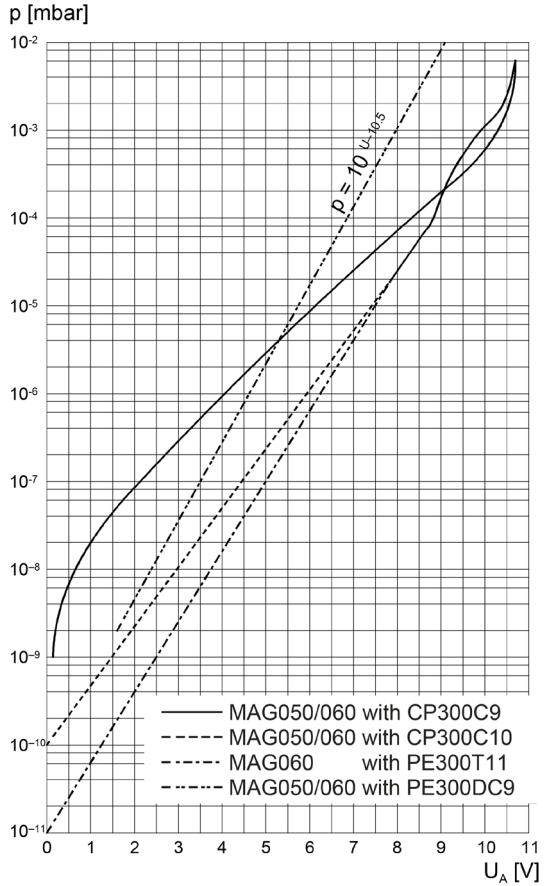

B: Gas Type Dependence

Pirani Gauges

Indicated pressure (Instrument calibrated for air)

p (mbar)

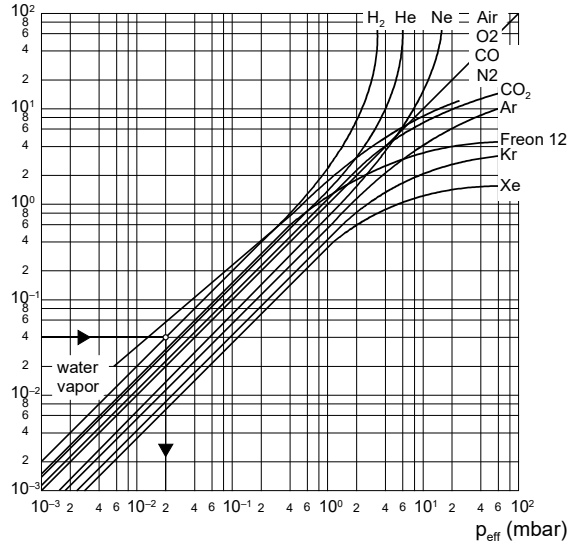

Cold Cathode Gauges

Indicated pressure (Instrument calibrated for air)

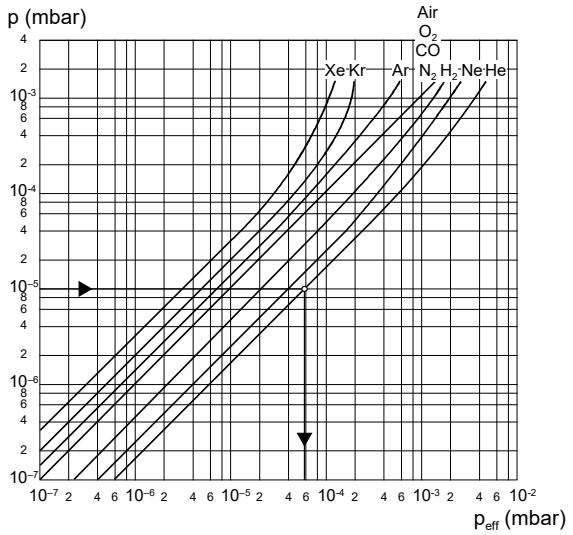



(Mean values, deviations possible depending on degree of contamination).

Reference gauge: Hot cathode ionization gauge

C: Literature

-  [1] www.inficon.com
Operating Manual
Total Pressure Gauge Controller VGC094
tinb68d1 (German)
tinb68e1 (English)
INFICON AG, LI-9496 Balzers, Liechtenstein

-  [2] www.inficon.com
Communication Protocol
PROFINET Interface Board IF500PN
tirb68e1 (English)
INFICON AG, LI-9496 Balzers, Liechtenstein

-  [3] www.inficon.com
Communication Protocol
PROFIBUS-DP Interface Board IF300P,
IF301P
IG 3973 BEN (English)
INFICON AG, LI-9496 Balzers, Liechtenstein

-  [4] www.inficon.com
Operating Manual
Pirani Gauge PSG010 / 017 / 018
tinb71e1 (English)
INFICON AG, LI-9496 Balzers, Liechtenstein

-  [5] www.inficon.com
Operating Manual
Cold Cathode Gauge MAG050 / 060 / 070
tinb43e1 (English)
INFICON AG, LI-9496 Balzers, Liechtenstein

-  [6] www.inficon.com
Operating Manual
Cold Cathode Gauge MAG084
tinb81e1 (English)
INFICON AG, LI-9496 Balzers, Liechtenstein



LI-9496 Balzers

Liechtenstein

Tel +423 / 388 3111

Fax +423 / 388 3700

reachus@inficon.com

Original: English



ig3972ben1b

www.inficon.com