

Total Pressure Gauge Controller VGC094

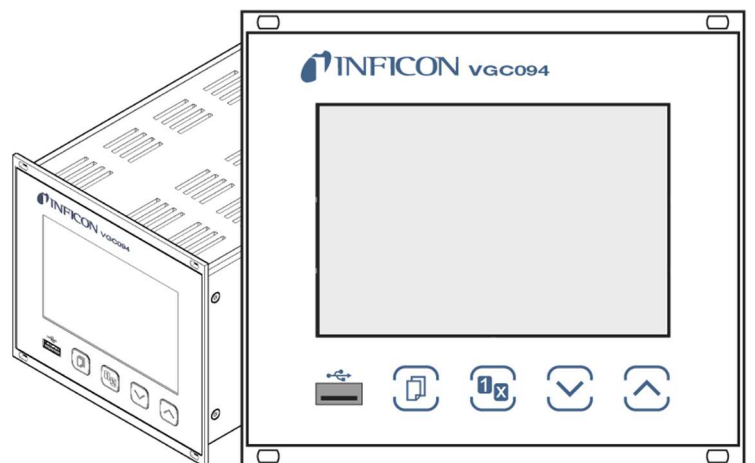

Product Identification

In all communications with INFICON, please specify the information on the product nameplate.

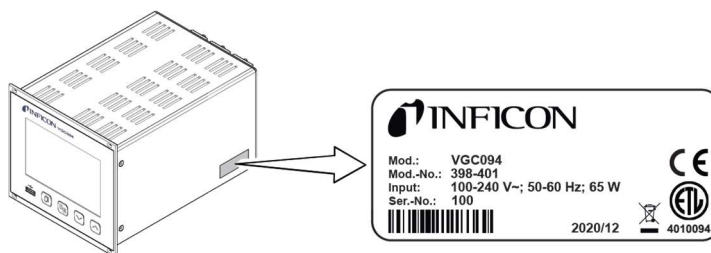

Specimen nameplate

Validity

This document applies to products with part number:

398-401 (VGC094)

The part number (Mod.-No) can be found on the product nameplate.

This manual is based on firmware version V1.30.

If your unit does not work as described in this document, please check that it is equipped with the above firmware version (→ 49).

We reserve the right to make technical changes without prior notice.

All dimensions are indicated in mm.

Intended Use

Depending on the options chosen, the VGC094 can measure total pressure from atmosphere to 10^{-11} mbar. It can trigger a number of pressure-dependent functions to control and monitor vacuum devices and processes. The instructions contained in this document must be strictly followed.

Scope of Delivery

The scope of delivery consists of the following parts:



- 1 Control Unit
- 1 Power cord
- 1 Accessories kit
 - 4 collar screws and synthetic nipple
 - 1 rubber strip
 - 2 self-adhesive rubber feet
 - 4 banana plugs, 2 mm, red
 - 4 banana plugs, 2 mm, black
 - 1 screwdriver, 2 mm
- 1 Installation Manual
- 1 CD ROM (manuals, tools, ...)
- 1 EU Declaration of Conformity

Contents

Product Identification	2
Validity	2
Intended Use	2
Scope of Delivery	2
1 Safety	6
1.1 Symbols Used	6
1.2 Personnel Qualifications	6
1.3 General Safety Instructions	7
1.4 Liability and Warranty	7
2 System Overview	8
2.1 Basic Unit	8
2.2 Measurement Plug-In Boards	8
2.3 Interface and Relay Plug-In Boards	9
3 Technical Data	10
4 Installation	13
4.1 Personnel	13
4.2 Installation, Setup	13
4.2.1 Rack Installation	13
4.2.2 Installation in a control panel	14
4.2.3 Use as Desk-Top Unit	15
4.3 Mains Power Connector	16
4.4 Installing / Removing plug-in boards	17
4.5 Interface Connectors	17
4.5.1 <i>CONTROL Connector</i>	17
4.5.2 Interface Connector <i>RS485</i>	19
4.5.3 Interface Connector USB Type A	19
4.5.4 Interface Connector USB Type B	19
4.5.5 Interface Connector Ethernet	20
5 Operation	21
5.1 Front Panel	21
5.2 Switching the VGC094 On and Off	22
5.3 Measuring with the VGC094	23
5.4 Operating Modes	23
5.5 Measurement Mode	25
5.6 Parameter Mode	27
5.6.1 Switching Function Parameters	28
5.6.2 Gauge parameters	30
5.6.3 Gauge Control	34
5.6.4 General Parameters	37
5.6.5 Communication Parameters	42
5.6.6 Plug-In Boards Parameters	44
5.6.7 Data Logger Mode	45
5.6.8 Setup Mode	47
5.6.9 Test Parameters	49
6 Communication Protocol (Serial Interface)	53
6.1 Data Transmission	53
6.2 Communication Protocol	54
6.3 Mnemonics	55
6.4 Measurement Mode	56
6.4.1 COM - Continuous Output of Measurement Values	56
6.4.2 ERR - Error Status	56
6.4.3 PA1 / PA2 - Measurement Data Channels A1 / A2	57
6.4.4 PB1 / PB2 - Measurement Data Channels B1 / B2	57
6.4.5 PRX - Measurement Data Channels A1, A2, B1, B2	58
6.4.6 RES - Reset	58
6.4.7 SEN - Switching Measurement Circuit On/Off	59
6.4.8 TID - Measurement Circuit Identification	59
6.5 Switching Function Parameters	60
6.5.1 SPS - Switching Function Status	60
6.5.2 SP1 ... SP4 - Switching Function 1 ... 4	60
6.6 Gauge Parameters	61
6.6.1 CA1, CA2 - Leakage Current Compensation	61
6.6.2 CB1, CB2 - Leakage Current Compensation	61
6.6.3 CID - Measuring Point Name	62

6.6.4	COR - Correction factor	62
6.6.5	FIL - Measurement Value Filter	63
6.6.6	GAS - Gas Type Correction	63
6.7	Gauge Control Group	64
6.7.1	SA1, SA2 - Gauge Control Slot A	64
6.7.2	SB1, SB2 - Gauge Control Slot B	65
6.7.3	SPA - Gauge Control Slot A	66
6.7.4	SPB - Gauge Control Slot B	67
6.8	General Parameters	68
6.8.1	AOM - Analog Output Mode	68
6.8.2	BAL - Backlight	68
6.8.3	DCB - Display Control Bar Graph	69
6.8.4	DCC - Display Control Contrast	70
6.8.5	DCS - Display Control Screensave	70
6.8.6	ERA - Error Relay Allocation	71
6.8.7	EVA - Measurement Range End Value	71
6.8.8	LNG - Language (Display)	71
6.8.9	PUC - Penning Underrange Control	72
6.8.10	SAV - Save Parameters (EEPROM)	72
6.8.11	UNI - Pressure Unit	73
6.9	Communication Parameters	74
6.9.1	BAU - Transmission rate USB	74
6.9.2	BAR - Transmission rate RS485	74
6.9.3	BAI - Transmission rate IFxxx	75
6.9.4	ETH - Ethernet Configuration	75
6.9.5	NAD - Node Address (unit address) for RS485	76
6.10	Data Logger Parameters	77
6.10.1	DAT - Date	77
6.10.2	LCM - Start / Stop Data Logger	77
6.10.3	TIM - Time	77
6.11	Group Setup	78
6.11.1	SCM - Store / Load Parameters (USB)	78
6.12	Test Parameters	78
6.12.1	ADC - A/D Converter Test	78
6.12.2	CDA - Re-calibration	78
6.12.3	DIS - Display Test	79
6.12.4	EEP - EEPROM Test	79
6.12.5	EPR - FLASH Test	79
6.12.6	HDW - Hardware Version	79
6.12.7	IOT - I/O Test	80
6.12.8	LOC - Keylock	80
6.12.9	MAC - Ethernet MAC Address	81
6.12.10	PNR - Firmware Version	81
6.12.11	RHR - Operating Hours	81
6.12.12	TKB - Operator Keys Test	81
6.12.13	TLC - Torr Lock	82
6.12.14	WDT - Watchdog Control	82
6.13	Further Parameters	82
6.13.1	AYT - Are you There?	82
6.13.2	SME - Show Me	83
6.13.3	TMP - Inner Temperature of the Unit	83
6.13.4	VBT - Battery Voltage	83
6.14	Example	84
7	Maintenance	85
8	Troubleshooting	86
9	Repair	87
10	Accessories	87
11	Storage	87
12	Disposal	88
Appendix		89
A:	ConversionTables	89
B:	Measurement Signal vs. Pressure	90
B 1:	Pirani Gauges, 0 ... 10 V	90
B 2:	Pirani Gauges, 4 ... 20 mA	91
B 3:	Measurement Plug-In Board CP300C9, 0 ... 10 V	92
B 4:	Measurement Plug-In Board CP300C9, 4 ... 20 mA	93
B 5:	Measurement Plug-In Board CP300C10, 0 ... 10 V	94
B 6:	Measurement Plug-In Board CP300C10, 4 ... 20 mA	95

B 7:	Measurement Plug-In Board CP300T11/T11L, 0 ... 10 V	96
B 8:	Measurement Plug-In Board CP300T11/T11L, 4 ... 20 mA	97
C:	Firmware Update	98
D:	Ethernet Configuration	102
D 1:	Connect the VGC094 to a Network	102
D 2:	Connect the VGC094 to a Computer	103
D 3:	Ethernet Configuration Tool	104
E:	Literature	107
	ETL Certification	107
	EU Declaration of Conformity	108

For cross-references within this document, the symbol (→  XY) is used; for cross-references to further documents listed under 'Literature', use is made of the symbol (→  [Z]).

1 Safety

1.1 Symbols Used









Symbols for residual risks

 DANGER
Information on preventing any kind of physical injury.

 WARNING
Information on preventing extensive equipment and environmental damage.

 Caution
Information on correct handling or use. Disregard can lead to malfunctions or minor equipment damage.

Further symbols

-  Note
-  Label on rear of the unit: prompt to consult the operating manual
-  The lamp / display is lit
-  The lamp / display flashes
-  The lamp / display is dark
-  Press the key (example: PARA key)
-  Do not press any key
-  Labeling

1.2 Personnel Qualifications

 Skilled personnel
All work described in this document may only be carried out by persons who have suitable technical training and the necessary experience or who have been instructed by the end-user of the product.

1.3 General Safety Instructions

Adhere to the applicable regulations and take the necessary precautions for all work you are going to do and consider the safety instructions in this document.

DANGER

Mains voltage
 Contact with live parts is extremely hazardous when any objects are introduced or any liquids penetrate into the unit.
 Make sure no objects enter through the louvers and no liquids penetrate into the equipment.

Disconnecting device

The disconnecting device must be readily identifiable by and easily reached by the user.

To disconnect the unit from the mains supply, you must unplug the mains cable.

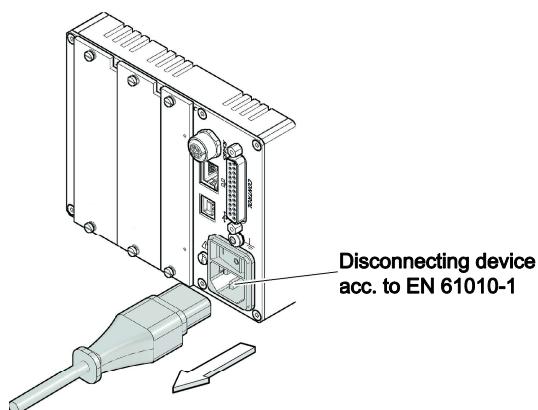

Communicate the safety instructions to all other users.

1.4 Liability and Warranty

INFICON assumes no liability and the warranty is rendered null and void if the end-user or third parties

- disregard the information in this document
- use the product in a non-conforming manner
- make any kind of interventions (modifications, alterations etc.) on the product
- use the product with accessories not listed in the corresponding product documentation.

2 System Overview

2.1 Basic Unit

VGC094, Technical Data → 10.

A list of all plug-in boards suited for the VGC094 can be found on → 9.

For detailed information on the plug-in boards → [1].

2.2 Measurement Plug-In Boards

Two slots (A and B) at the back of the VGC094 can accommodate up to two measurement boards.

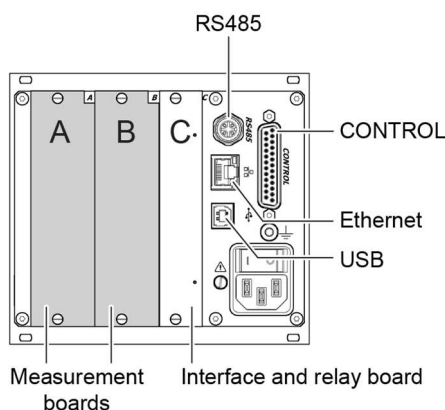

Measurement plug-in board:

Pirani



Cold cathode



Pirani / cold cathode combined



		PI300D	PI300DN	PE300DC9	CP300C9	CP300C10	CP300T11 CP300T11L
Compatible gauges:							
PSG010		•			•	•	•
PSG017			•				
PSG018		•			•	•	•
MAG050				•	•	•	
MAG060				•	•	•	
MAG070							•
MAG084					•		

2.3 Interface and Relay Plug-In Boards



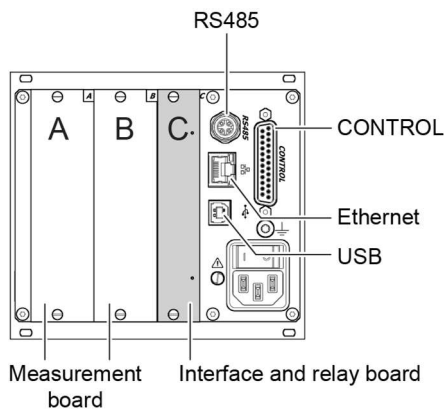

An interface and relay board can be plugged into slot C.



RS232C interface and relays	RS232C interface and relays	RS422 interface and relays	Profibus interface and relays	Profinet interface
IF300A	IF300B	IF300C	IF300P, IF301P	IF500PN

3 Technical Data

Mains specifications	Voltage	100 ... 240 V (ac) ±10%
	Frequency	50 ... 60 Hz
	Power consumption	≤65 VA
	Overvoltage category	II
	Protection class	1
	Connection	European appliance connector IEC 320 C14
	Fuse	integrated in power supply unit (fuse is not accessible)
Ambience	Ambient temperature	
	Storage	-20 ... +60 °C
	Operation	+ 5 ... +50 °C
	Relative humidity	≤80% up to +31 °C, decreasing to 50% at +40 °C
	Use	indoors only max. altitude 2000 m
	Pollution degree	II
	Degree of protection	IP30
Slots for plug-in boards	Measurement boards	2 (slot A and B)
	Interface and relay boards	1 (slot C)
Compatible measurement boards	Pirani	PI300D PI300DN
	Cold cathode	PE300DC9, index B and higher
	Pirani / cold cathode combined	CP300C9, index B and higher CP300C10, index B and higher CP300T11, index B and higher CP300T11L, index A and higher
Compatible interface and relay boards	RS232C interface (D-sub connector) and relays	IF300A
	RS232C interface (cable) and relays	IF300B
	RS422 interface and relays	IF300C
	Profibus interface and relays	IF300P, IF301P
	Profinet interface	IF500PN
Operation	Front panel	via 4 keys
	Remote control	via RS485 interface via USB type B interface via Ethernet interface
Measurement values	Measurement ranges	depending on plug-in boards (→  [1])
	Measurement rate analog	≥100 / s
	Display rate	≥10 / s
	Measurement filter	
	Limit frequency	OFF, 100 Hz, 10 Hz (default), 1 Hz, 0.1 Hz
Measurement unit	hPa, mBar, Torr, Pa, Micron, V, A	

Relay contacts	Switching function relays	4
	Error relay	1
	Contact type	floating changeover contact
	Max. load	60 V (dc), 0.6 A (ohmic) 40 V (ac), 1 A (ohmic) 30 V (dc), 1.5 A (ohmic) 30 V (ac), 1.5 A (ohmic)
	Service life	
	Mechanical	1×10 ⁸ switching cycles
	Electrical	1×10 ⁵ switching cycles (at max. load)
	Contact positions	→  17
	Reaction time	≤10 ms
	Allocation of switching points	freely assignable
	Setting range switching points	depending on gauges
	Hysteresis switching points	≥10% of reading
	CONTROL connection	D-sub appliance connector, female, 25-pin (pin assignment →  17)
	Analog outputs	Number
Voltage range		0 ... +10 V (dc) ±1% (±0.2% typical) 0 ... +5 V (dc)
Current range		4 ... 20 mA ±1% (±0.2% typical)
Resolution		16 Bit
Output resistance		<50 Ω (typical 47.5 Ω)
Response time		≤10 ms
CONTROL connector		D-sub appliance connector, female, 25-pin (pin assignment →  17)
RS485 interface		Protocol
	Data format	bi-directional, 1 start bit, 8 data bits, 1 stop bit, no parity bit, no handshake
	Transmission rate (Baud)	9600, 19200, 38400, 57600, 115200
	RS485 connector	Binder M12 appliance connector, 5-pin (pin assignment →  19)
USB Type A interface	Protocol	FAT file system file handling in ASCII format
USB Type B- interface	Protocol	Mnemonics protocol, ASCII
	Transmission rate (Baud)	9600, 19200, 38400, 57600, 115200
Ethernet interface	Protocol	Mnemonics protocol, ASCII
	Configuration	→  102

Dimensions [mm]

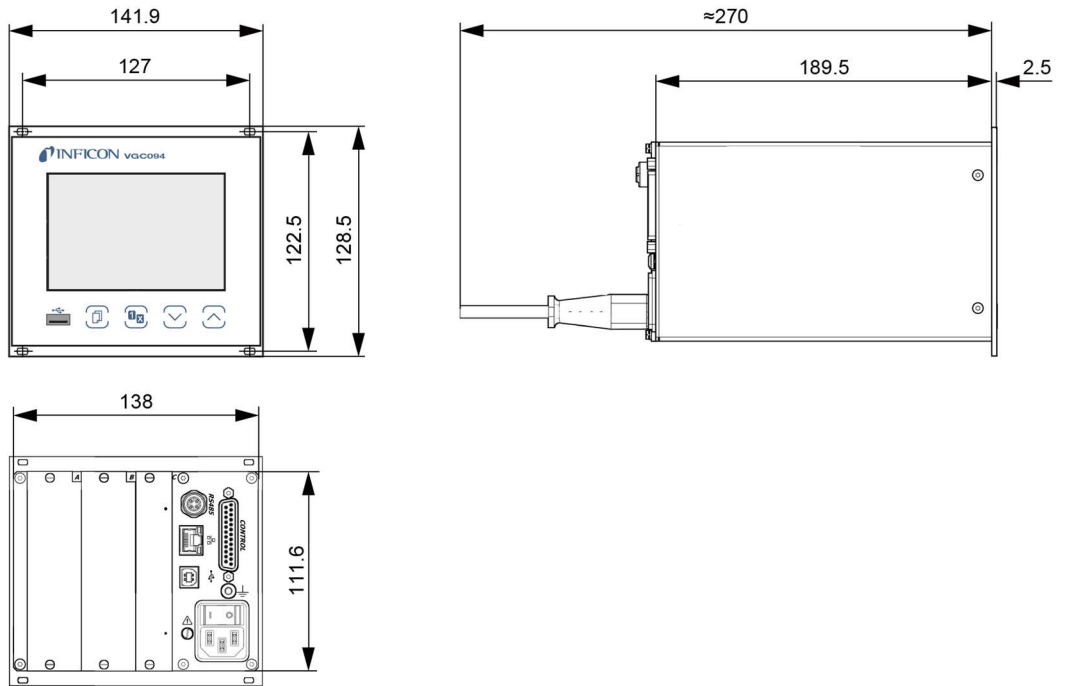

Use For incorporation into a rack or control panel or as a desk-top unit

Weight <1.45 kg

4 Installation

4.1 Personnel



Skilled personnel

The unit may only be installed by persons who have suitable technical training and the necessary experience or who have been instructed by the end-user of the product.

4.2 Installation, Setup

The unit is suited for incorporation into a 19" rack or a control panel or for use as a desk-top unit.



DANGER

Putting a product which is visibly damaged into operation can be extremely hazardous. If the product is visibly damaged do not put it into operation and make sure it is not inadvertently put into operation.

4.2.1 Rack Installation

The unit is designed for installation into a 19" rack chassis adapter according to DIN 41 494. For this purpose, four collar screws and plastic sleeves are supplied with it.



DANGER

Protection class of the rack

If the product is installed in a rack, it is likely to lower the protection class of the rack (protection against foreign bodies and water) e.g. according to the EN 60204-1 regulations for switching cabinets.

Take appropriate measures for the rack to meet the specifications of the protection class.

Guide rail

In order to reduce the mechanical strain on the front panel of the VGC094, preferably equip the rack chassis adapter with a guide rail.

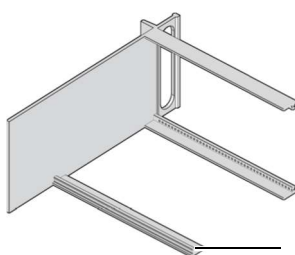

Guide rail

Height 3 rack chassis adapter

- 1 Secure the rack adapter in the rack frame.



The maximum admissible ambient temperature (→ 10) must not be exceeded and the air circulation must not be obstructed.

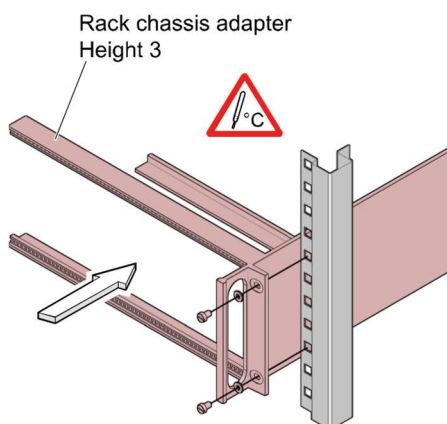

- 2 Slide the VGC094 into the rack chassis adapter ...

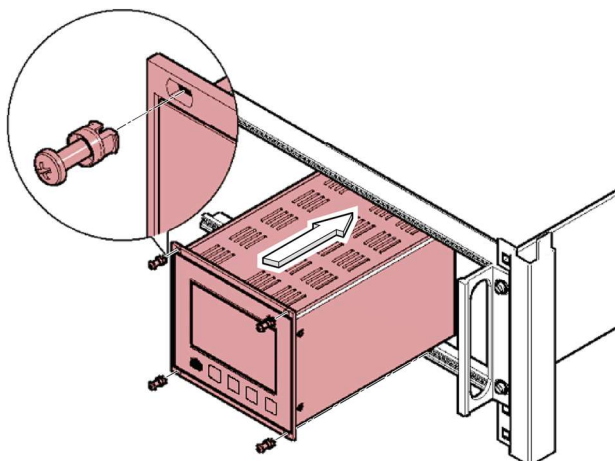

... and fasten the adapter panel to the rack chassis adapter using the screws supplied with the VGC094.

4.2.2 Installation in a control panel

STOP DANGER



Protection class of the rack

If the product is installed in a rack, it is likely to lower the protection class of the rack (protection against foreign bodies and water) e.g. according to the EN 60204-1 regulations for switching cabinets.

Take appropriate measures for the rack to meet the specifications of the protection class.

For mounting the VGC094 into a control panel, the following cut-out is required:

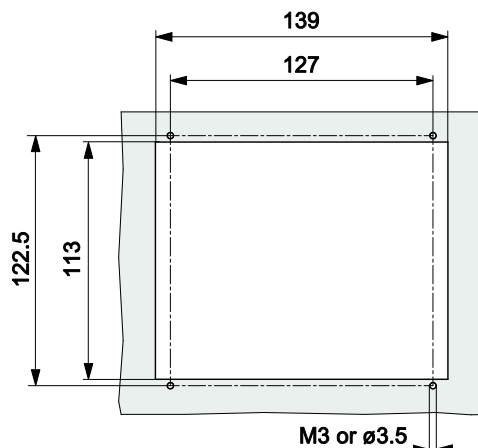

The maximum admissible ambient temperature (→ 10) must not be exceeded and the air circulation must not be obstructed.

For reducing the mechanical strain on the front panel of the VGC094, preferably support the unit.

- 1 Slide the VGC094 into the cut-out of the control panel ...

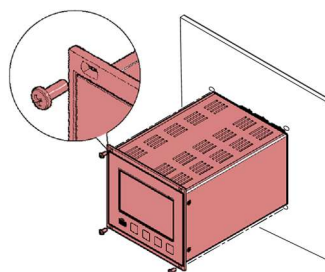

... and secure it with four M3 or equivalent screws.

4.2.3 Use as Desk-Top Unit

The VGC094 may also be used as a desk-top unit. For this purpose, two self-adhesive rubber feet and a slip-on rubber bar are supplied with it.

- 1 Stick the two supplied rubber feet to the rear part of the bottom plate ...

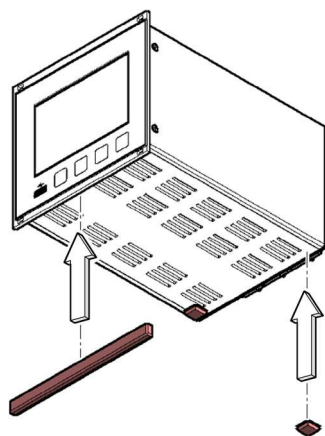

... and slip the supplied rubber bar onto the bottom edge of the front panel.



Select a location where the admissible maximum ambient temperature (→ 10) is not exceeded (e.g. due to sun irradiation).

4.3 Mains Power Connector

DANGER

Line voltage
 Incorrectly grounded products can be extremely hazardous in the event of a fault.

Use only a 3-conductor power cable with protective ground. The mains power connector may only be plugged into a socket with a protective ground. The protection must not be nullified by an extension cable without protective ground.

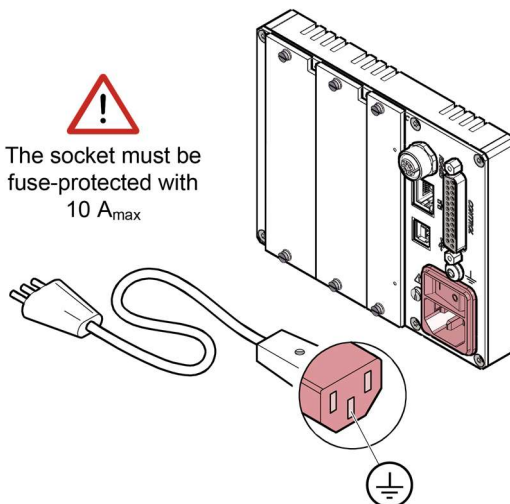

If the unit is installed in a switching cabinet, the mains voltage should be supplied and turned on via a central distributor.

Ground Connection

On the rear of the unit is a screw enabling the VGC094 where necessary to be connected via a ground conductor, e.g. with the protective ground of the pump stand.

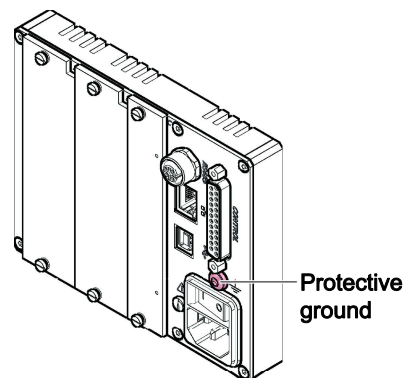

Internal protection ground

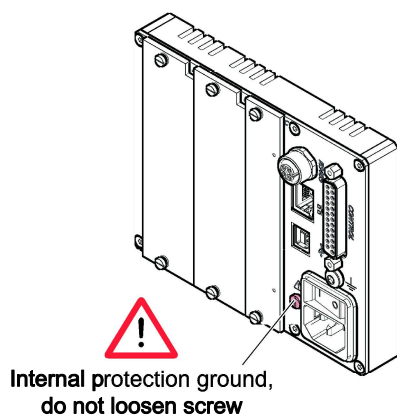

4.4 Installing / Removing plug-in boards

Further information and details on installing/removing plug-in boards and handling of empty slots you find in [1].

Connecting plug-in boards

Electrical connections of gauges, analog signals, relays contacts etc. depend on the plug-in boards used and are described in [1] in detail.

4.5 Interface Connectors

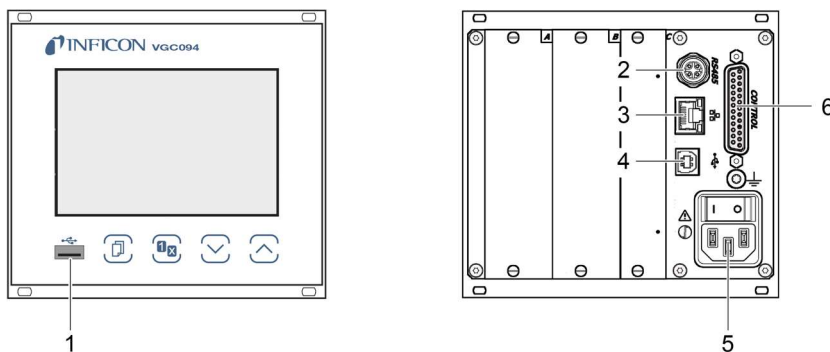

1		USB Type A interface	→ 19
2	RS485	RS485 interface	→ 19
3		Ethernet interface	→ 20
4		USB Type B interface	→ 19
5		3-pin mains power connector	→ 16
6	CONTROL	Relay contacts connector, analog outputs	→ 17

4.5.1 CONTROL Connector

The switching functions and error monitoring influence the position of various relays. You can use the relay contacts for switching via the *CONTROL* connection. The relay contacts are floating contacts.

In addition, the measuring signal can be read out via this connection and the status of the error monitoring can be evaluated potential-free.



Connect the peripheral components to the *CONTROL* connector on the rear of the unit using your own, screened (EMC compatibility) cable.



Hazardous voltage
 According to EN 61010, voltages exceeding 30 V (ac) or 60 V (dc) are hazardous.
 Only connect a protective low voltage.

Pin assignment, contact positions *CONTROL*

Pin assignment of the male 25-pin D-sub appliance connector (female):

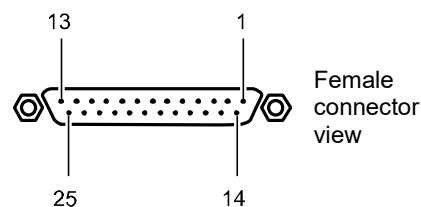

Pin	Signal
	Switching function 1
8 16 7	Pressure above threshold or power supply turned off Pressure below threshold
	Switching function 2
5 13 4	Pressure above threshold or power supply turned off Pressure below threshold
	Switching function 3
2 10 1	Pressure above threshold or power supply turned off Pressure below threshold
	Switching function 4
15 6 14	Pressure above threshold or power supply turned off Pressure below threshold
	Error signal
12 3 11	Error or power supply turned off No error
	Supply for relays with higher switching capacity
9	+24 V (dc), 100 mA Fuse-protected at 100 mA with PTC element, self-resetting after power off or pulling the <i>CONTROL</i> connector. Meets the requirements of a grounded protective extra low voltage.
17	GND
18	AGND (analog ground)
19	Analog Output 1
20	AGND (analog ground)
21	Analog Output 2
22	AGND (analog ground)
23	Analog Output 3
24	AGND (analog ground)
25	Analog Output 4

4.5.2 Interface Connector RS485

The galvanically isolated RS485 interface enables operation of the VGC094 via a computer or a terminal. Integration into a bus system is possible with the use of a Y distributor.



Connect the serial interface to the *RS485* connector on the rear of the unit using a screened (EMC compatibility) cable.

Pin assignment
RS485

Pin assignment of the female binder 5-pin M12 appliance connector socket:

Pin	Signal
1	RS485+ (differential)
2	+24 V (dc), ≤200 mA
3	GND
4	RS485- (differential)
5	not assigned

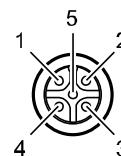

Female connector view

4.5.3 Interface Connector USB Type A

The USB Type A interface connector with master functionality is situated on the front of the unit and is used for the connection of a USB memory stick (e.g. firmware update, parameter saving (read/write), data logger).



Connect the USB memory stick to the connector  on the front of the unit.

USB type A
pin assignment

Pin assignment of the 4-pin USB type A connector socket:

Pin	Signal
1	VBUS (5 V)
2	D-
3	D+
4	GND

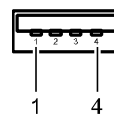

Female connector view

4.5.4 Interface Connector USB Type B

The USB Type B interface connector facilitates direct communication with the VGC094 via a computer (e.g. firmware update, parameter saving (read/write)).



Connect the USB interface connector to the  connector on the rear of the unit using a screened (electromagnetic compatibility) cable.



If a virtual serial interface (COM) is not set up automatically, you can download the driver from "www.ftdichip.com/drivers/vcp-drivers/" and then install it.

Pin assignment
USB Type B

Pin assignment of the female 4-pin USB type B connector socket:

Pin	Signal
1	VBUS (5 V)
2	D-
3	D+
4	GND

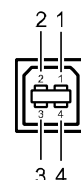

Female connector view

4.5.5 Interface Connector Ethernet

The Ethernet interface allows direct communication with the VGC094 via a computer.



Connect the Ethernet cable to the connector  on the rear of the unit.

Pin assignment Ethernet

Pin assignment of the 8-pin RJ45 appliance connector socket:

Pin	Signal
1	TD+ (transmission data +)
2	TD- (transmission data -)
3	RD+ (received data +)
4	n.c.
5	n.c.
6	RD- (received data -)
7	n.c.
8	n.c.

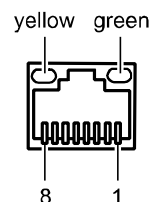

Female connector view

Green LED

Link or transmit LED. Indicates that a hardware connection has been established.

Yellow LED

Status or packet-detect LED. Indicates the status of the transmission. Whenever this LED flashes or flickers, this indicates that data is being transmitted.

5 Operation

5.1 Front Panel

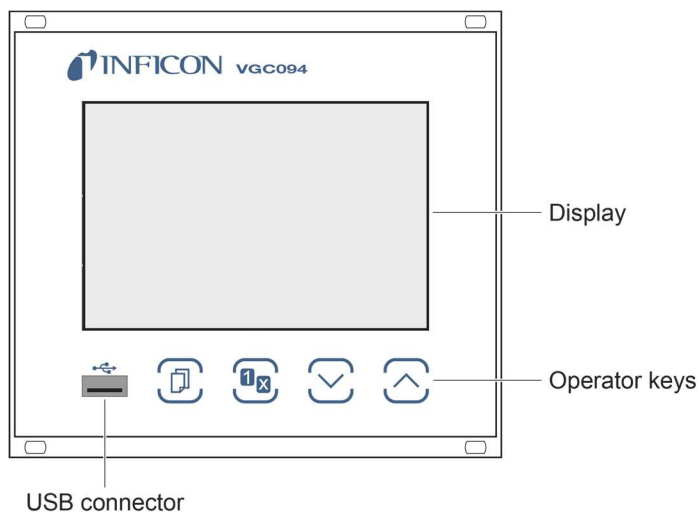

Display VGC094

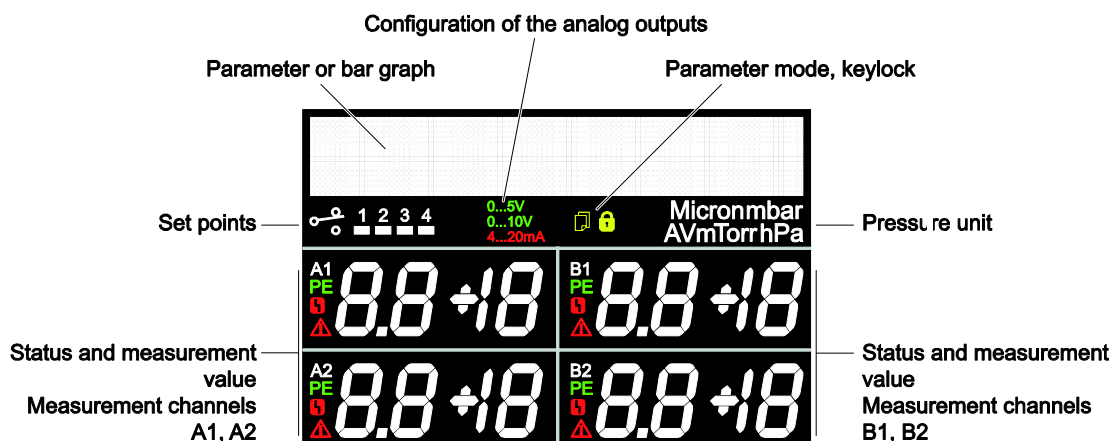

Parameter, bar graph

Parameter rows 1 & 2



Bar graph. The symbol of the corresponding measuring channel flashes (e.g. A1).



Bar graph with setpoint. The symbol of the corresponding measuring channel flashes (e.g. A1).



Pressure vs. time, trend. The symbol of the corresponding measuring channel flashes (e.g. **A1**).



Switching points, parameter mode, keylock

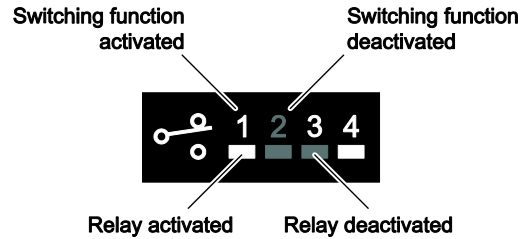

Parameter mode activated



Keylock on

Specific measurement channel

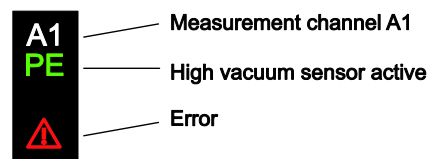

5.2 Switching the VGC094 On and Off

Make sure the unit is correctly installed and the specifications in the Technical Data are met.

Switching on the VGC094

The power switch is on the rear of the unit.

Switch on the VGC094 at the power switch (or, if the unit is incorporated in a rack, switch it on centrally via a switched power distributor).

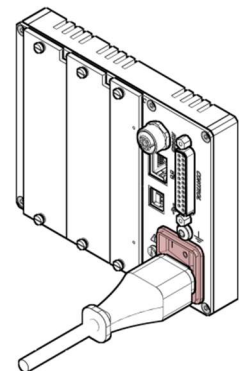

After power on, the VGC094 ...

- automatically performs a self-test
- activates the parameters that were in effect before the last power off
- all measuring circuits with activated hot start (→ 34) and all operational Pirani gauges are switched on
- the identification of the measuring point is displayed.

Turning the VGC094 off

Turn the VGC094 off with the power switch (or centrally, via a switched power distributor, if the unit is incorporated in a rack).



Wait at least 10 s before turning the VGC094 on again in order for it to correctly initialize itself.

5.3 Measuring with the VGC094

Gas type dependence	The measured pressure depends on the gas type present. It is referenced to nitrogen (N ₂). For other gases please refer to the characteristic curves shown in the appendix of the plug-in card operating manual [1].
Validity of displayed data	If you intend to use the measurement results for control functions, allow for the time constants of the VGC094, the gauges, possible ignition delays etc., until valid measurements are displayed (→ [2], [3]).
Accuracy of measurement	<p>A generally applicable statement on the accuracy of the measurement cannot be made. The type of gas being measured is a major factor affecting the accuracy, and so is the current condition of the gauge.</p> <p>The accuracy of the gauge at any particular moment can only be assessed by comparing the results with a reference unit. Calibration pumping systems are available for reliable measurements, particularly for pressures under 10⁻⁴ hPa.</p>
Adjustment	Cold cathode measuring circuits are factory adjusted and require no recalibration. Pirani measuring circuits are factory adjusted. For accurate measurement → [1].

5.4 Operating Modes

The VGC094 works in the following operating modes:

- Measurement mode
for displaying measurement values or status (→ [25])
- Parameter mode
for displaying and editing parameters (→ [27])
 - Switching function parameter group **SETPOINT** [28]
for entering and displaying thresholds (→ [28])
 - Gauge parameter group **SENSOR** [30]
for entering and displaying gauge parameters (→ [30])
 - Gauge control group **SENSOR-CONTROL** [34]
for entering and displaying gauge control parameters (→ [34])
 - General parameter group **GENERAL** [37]
for entering and displaying general parameters (→ [37])
 - Communication parameter group **COMMUNICATION** [42]
for entering and displaying communication parameters (→ [42])
 - Plug-In Boards parameter group **PLUG-IN BOARDS** [44]
for displaying plug-in boards parameters (→ [44])
 - Data logger mode **DATA LOGGER** [45]
for logging measurement data (→ [45])
 - Program transfer mode **SETUP** [47]
for saving (read/write) parameters (→ [47])
 - Test program group **TEST** [49]
for running internal test programs (→ [49])

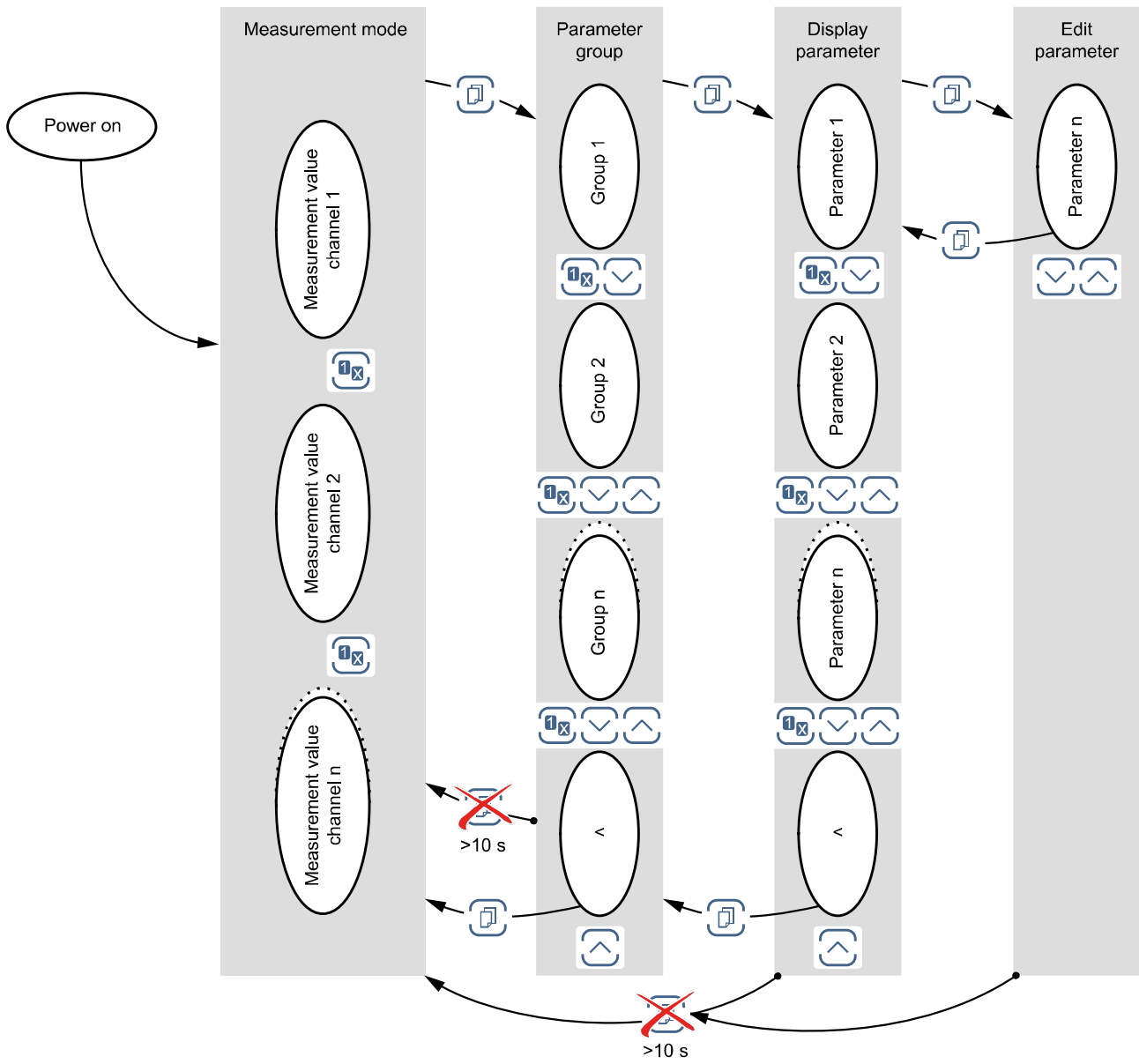

5.5 Measurement Mode

Measurement mode is the standard operating mode of the VGC094 with display of

- a bar graph (if required)
- a measurement value for each measurement channel
- status messages for each measurement channel

Adjusting bar graph

If required a bar graph may be displayed (→ 39).

Changing measurement channel



The unit alternates between the measurement channels. The number of the selected measurement channel flashes.

Switching the gauge on/off



Manual on/off-switching has priority over the automatic control (switch to automatic control → 34).

The controller does not put Pirani gauges out of operation when switched off, but suppresses the measurement result and the error message.



Switch on cold cathode gauges at pressures $<10^{-3}$ hPa only, in order to prevent excessive contamination of the gauges.

Switching on/off manually



⇒ Press key for >1 s:
Gauge switches on. A measurement value or a status message is displayed.

PE



⇒ Press key for >1 s:
Gauge switches off. The identification of the measuring board is displayed.

PE 9	Cold cathode measuring circuit 5×10^{-9} hPa
PE 10	Cold cathode measuring circuit 1×10^{-10} hPa
PE 11	Cold cathode measuring circuit 1×10^{-11} hPa
PI	Pirani measuring circuit
PI n	Pirani measuring circuit for nickel filament

Switching on/off automatically

After switching on a gauge, a measurement value or a status message is displayed.

After switching on a gauge, the identification of the measuring board is displayed.

AJ 9	Cold cathode measuring circuit 5×10^{-9} hPa automatic operation
AJ 10	Cold cathode measuring circuit 1×10^{-10} hPa automatic operation
AJ 11	Cold cathode measuring circuit 1×10^{-11} hPa automatic operation

Measured value display

The four measuring channels are displayed simultaneously. The measuring channel symbol of the active measuring channel flashes.

If the measured value of a measuring circuit is outside the measuring range, "or" (overrange) or "ur" (underrange) is displayed, together with the exponent which indicates the range limit.

Instead of "or" and "ur", the respective end value of the measuring range can be displayed (→ Parameter "END VALUE", § 41),

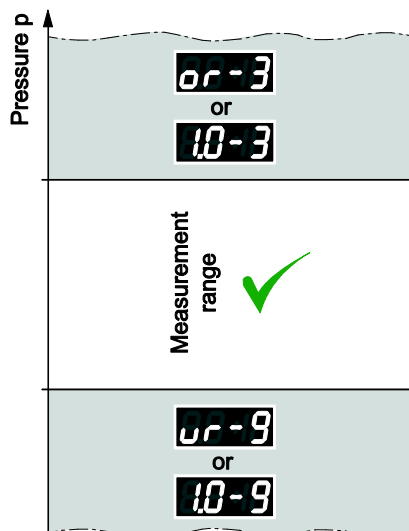

If the upper measuring range limit is exceeded, the cold cathode gauge can become contaminated if it remains switched on.



If the under range control is switched off the system cannot distinguish between a gauge failure, cable interruption and underrange of a cold cathode measuring circuit. "ur" is displayed in all cases.

Displaying the measurement plug-in board identification and gauge type



⇒ Press keys for >0.5 ... 1 s:
For the measurement channel in question, the measurement plug-in board identification (row 1) and the gauge type (row 2) are read and displayed for 10 seconds.

Example:

Row 1	CP300C9	Measurement plug-in board
Row 2	MPG050/060/084	Gauge

Measurement plug-in board (row 1)

PI300D	Pirani measurement plug-in board 8×10^{-4} mbar
PI300DN	Pirani measurement plug-in board 8×10^{-4} mbar
PE300DC9	Cold cathode measurement plug-in board 1×10^{-9} mbar
CP300C9	Pirani / cold cathode measurement plug-in board 5×10^{-9} mbar
CP300C10	Pirani / cold cathode measurement plug-in board 1×10^{-10} mbar
CP300T11	Pirani / cold cathode measurement plug-in board 1×10^{-11} mbar
CP300T11L	Pirani / cold cathode measurement plug-in board 1×10^{-11} mbar

5.6 Parameter Mode

The Parameter mode is used for displaying, editing and entering parameter values as well as for testing the VGC094 and for saving measurement data. For ease of operation the individual parameters are divided into groups.



Unit switches from measurement mode to parameter mode. The respective parameter group is displayed in place of the bar graph.



Selecting a parameter group

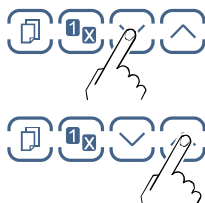

- ⇒ Switching function parameters → 28
- Gauge parameters → 30
- Gauge control → 34
- General parameters → 37
- Communication parameters → 42
- Plug-in boards parameters → 44
- Data logger → 45
- Setup → 47
- Test parameters → 49



Confirm group

Reading a parameter in a parameter group

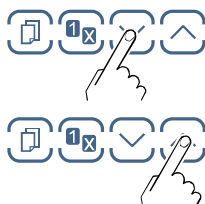

Editing and saving a parameter in a parameter group

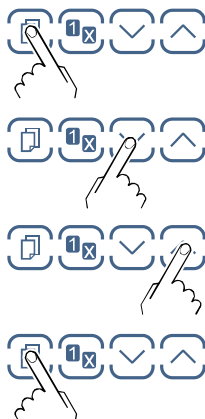

Confirm the parameter. The value flashes and can now be edited.

Edit the value.

Save the change and return to read mode

5.6.1 Switching Function Parameters

SETPOINT >

The switching function parameter groups used for displaying, editing and entering threshold values and assigning the six switching functions to a measurement channel.

Parameters in this group

SETPOINT 1 CH

Assignment of switching function 1 to a channel

SETPOINT 1 LOW

Switching function 1 lower threshold

SETPOINT 1 HIGH

Switching function 1 upper threshold

SETPOINT 1 ON-T

Delays the switching off of the relay (ON-Timer)

SETPOINT 2 CH

Assignment of switching function 2 to a channel

SETPOINT 2 LOW

Switching function 2 lower threshold

SETPOINT 2 HIGH

Switching function 2 upper threshold

SETPOINT 2 ON-T

Delays the switching off of the relay (ON-Timer)

SETPOINT 3 CH

Assignment of switching function 3 to a channel

SETPOINT 3 LOW

Switching function 3 lower threshold

SETPOINT 3 HIGH

Switching function 3 upper threshold

SETPOINT 3 ON-T

Delays the switching off of the relay (ON-Timer)

SETPOINT 4 CH

Assignment of switching function 4 to a channel

SETPOINT 4 LOW

Switching function 4 lower threshold

SETPOINT 4 HIGH

Switching function 4 upper threshold

SETPOINT 4 ON-T

Delays the switching off of the relay (ON-Timer)

<

One level back

Parallel to the IF300x plug-in boards, the VGC094 has four switching functions with two adjustable thresholds each. The status of the switching functions is displayed on the front panel and can be evaluated via the floating contacts at the *CONTROL* connector (→ 17).

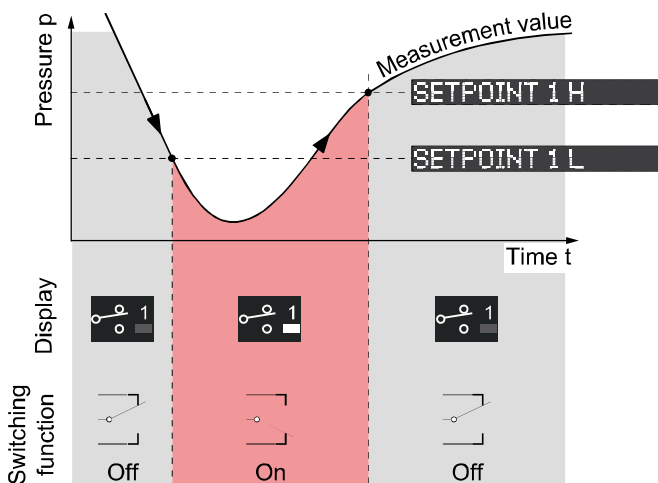

Selecting a parameter

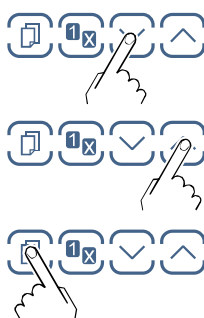

⇒ The name of the parameter and the currently valid parameter value are displayed.

e.g.: `SETPOINT 1 CH`
`DISABLED`
Switching function 1 turned off

⇒ Select parameter. The value flashes and can now be edited.

Editing and saving the parameter

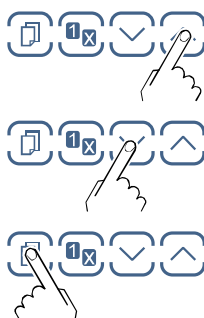

⇒ Press key for <1 s:
The value is increased/decreased by 1 increment.

Press key for >1 s:
The value is increased/decreased continuously.

⇒ Save the change and return to read mode.



We recommend setting the threshold $\frac{1}{2}$ decade above the lower, or $\frac{1}{2}$ decade below the upper, threshold limit.

Assigning a switching function

	Value
Row 1	<code>SETPOINT 1 CH</code> Assignment of a switching function to a measurement channel.
Row 2	<code>DISABLED</code> ⇒ Switching function 1 is factory-deactivated
	<code>ENABLED</code> ⇒ Switching function 1 is turned on
	<code>SENSOR A1</code> ⇒ Switching function 1 is assigned to sensor A1
	<code>SENSOR A2</code> ⇒ Switching function 1 is assigned to sensor A2
	<code>SENSOR B1</code> ⇒ Switching function 1 is assigned to sensor B1
	<code>SENSOR B2</code> ⇒ Switching function 1 is assigned to sensor B2



The lower and the upper threshold of a switching function are always assigned to the same channel. The last assignment is valid for both thresholds.

Limits of the lower switching thresholds

The threshold value can be set in the range 1.0E-11 ... 9.9E+3 mbar.

This parameter only appears if a sensor (SENSOR A1, SENSOR A2, SENSOR B1 or SENSOR B2) is assigned to the setpoint.

	Value
Row 1	<code>SETPOINT 1 LOW</code> The lower threshold (Setpoint low) defines the pressure at which the switching function is activated when the pressure is dropping.
Row 2	<code>1.0E-11</code> ⇒ Default



The minimum hysteresis between the upper and lower switching threshold amounts to at least 10% of the lower threshold. The upper threshold is if necessary automatically adjusted to a minimum hysteresis. This prevents unstable states.

Limits of the upper switching thresholds

The threshold value can be set in the range 1.0E-11 ... 9.9E+3 mbar. This parameter only appears if a sensor (SENSOR A1, SENSOR A2, SENSOR B1 or SENSOR B2) is assigned to the setpoint.

	Value
Row 1 SETPOINT 1 HIGH	The upper switching threshold (Setpoint high) defines the pressure at which the switching function is deactivated when the pressure is rising.
Row 2 9.0E-11	⇒ Default



The minimum hysteresis between the upper and lower switching threshold amounts to at least 10% of the lower threshold. This prevents unstable states.

ON-Timer

Entering an ON-Timer value delays the switch-off of the relay. The value can be set in the range 0 ... 100 seconds.

If the ON-Timer value is set to 30 seconds, for example, the relay will not be switched off until 30 seconds after SP-H has been exceeded. However, if the measured value returns below SP-L within the 30 seconds, the relay remains activated and the ON-Timer is reset.

	Value
Row 1 SETPOINT 1 ON-T	Parameter name
Row 2 0s	⇒ 0 seconds (default). Adjustable in the range 0 ... 100 seconds

5.6.2 Gauge parameters

SENSOR >

The sensor parameter group is used for displaying, entering and editing parameters of the connected gauges.

Parameters in this group

FILTER

Measurement value filter.

GAS TYPE

Correction factor for other gases.

CORR-FACTOR

Correction factor.

DESIGNATION

Measuring point name.

COMPENSATION

Leakage current compensation.

<

One level back.

Measurement value filter

The measurement value filter permits a better evaluation of unstable or disturbed measuring signals.

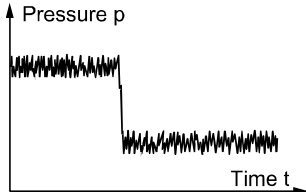
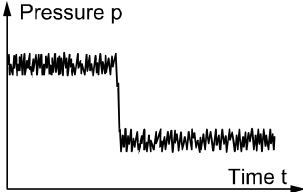
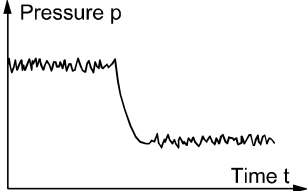
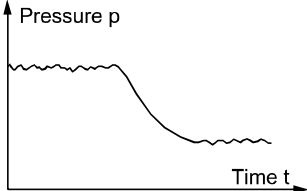

The measurement value filter does not affect the analog output (→ 17).

	Value
Row 1 FILTER	Parameter name
Row 2 1 kHz	<p>⇒ OFF</p> <p>The VGC094 responds as quickly as possible to fluctuations in the measurement values.</p> 
100 Hz	<p>⇒ 100 Hz:</p> <p>The VGC094 responds quickly to fluctuations in the measurement value. As a result, it will respond faster to interference in the measured values.</p> 
10 Hz	<p>⇒ 10 Hz (default):</p> <p>Good relationship between response and sensitivity of the display and the switching function to changes in the measured values.</p> 
1 Hz	<p>⇒ 1 Hz:</p> <p>The VGC094 responds slowly to fluctuations in the measurement value. As a result, it will respond slowly to interference in the measured values.</p> 

0.1 Hz

⇒ 0.1 Hz:
The VGC094 responds very slowly to fluctuations in the measurement value. As a result, it will respond very slowly to interference in the measured values.

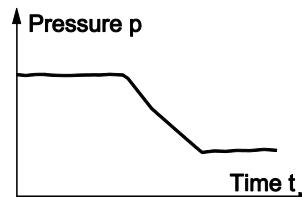

Correction factor GAS TYPE

The correction factor GAS TYPE allows

- the measurement value to be calibrated to the predefined gas types, or
- the manual input of the correction factor for other gases (CORR-FACTOR).

	Value
Row 1 GAS TYPE	Parameter name
Row 2 NITROGEN/AIR	⇒ Gas type: Nitrogen / air
HELIUM	⇒ Gas type: Helium
NEON	⇒ Gas type: Neon
ARGON	⇒ Gas type: Argon
KRYPTON	⇒ Gas type: Krypton
XENON	⇒ Gas type: Xenon
HYDROGEN	⇒ Gas type: Hydrogen
CORR-FACTOR	⇒ Manually enter correction factor for other gases via parameter CORR-FACTOR

Correction factor CORR-FACTOR

The correction factor is effective over the entire measuring range and allows the measurement value to be calibrated to other gas types.

Precondition: The GAS TYPE parameter must be set to the CORR-FACTOR value.

	Value
Row 1 CORR-FACTOR	Parameter name
Row 2 1.00	⇒ No correction Adjustable in the range 0.20 ... 8.00

Designation

Name of measuring point (8 characters max.).

	Value
Row 1 DESIGNATION	Parameter name
Row 2 FORELINE	⇒ Measuring point name (only capital letters, numbers and underlines permitted). A1 = default for sensor A1)

Leakage current compensation

A leakage current compensation value can be determined automatically for each measuring channel with a cold cathode or set manually via an interface command. The compensation value is subtracted from the measured pressure value. This enables an automatic correction of pressure values which are falsified by leakage currents caused by long cables.

	Value
Row 1 <code>COMPENSATION</code>	Parameter name
Row 2 <code>OFF</code>	⇒ Compensation disabled
<code>1.0E-9</code>	⇒ Compensation value (in current pressure unit) Start automatic measurement for leakage current compensation: Press and hold the UP button for ~1s. The text "MEASURING..." is displayed.

5.6.3 Gauge Control

SENSOR-CONTROL >

The sensor control group is used for displaying, entering and editing parameters which define how the connected gauges are activated / deactivated.

Parameters in this group

SENSOR ON	Gauge activation
SENSOR OFF	Gauge deactivation
THRESHOLD ON	ON threshold
THRESHOLD OFF	OFF threshold
<	One level back

General information

- Switching a gauge on/off can be done from different control sources.
- A gauge cannot turn itself on and cannot be turned off by HotStart.
- Pirani gauges remain active after switching off and the display shows "PI" instead of the measurement value. Any cold cathode gauge connected to the same plug-in board will also be switched off.

Gauge activation

Certain gauges can be activated by different means.

The parameter values "SENSOR A1", "SENSOR A2", "SENSOR B1" and "SENSOR B2" are only displayed for the available channels.

	Value
Row 1	SENSOR ON
Row 2	HAND
	HOTSTART
	SENSOR A1
	SENSOR A2
	SENSOR B1
	SENSOR B2
	HOTSTART + A1
	HOTSTART + A2
	HOTSTART + B1
	HOTSTART + B2

	Value
Parameter name	
⇒ Manual activation:	The gauge is activated by pressing the key (default).
⇒ Hot start:	The gauge is automatically activated when the VGC094 is turned on. Measurement is thus automatically resumed after a power failure. Conditions for gauge deactivation → 36.
⇒ By measurement channel A1.	
⇒ By measurement channel A2.	
⇒ By measurement channel B1.	
⇒ By measurement channel B2.	
⇒ By hotstart and measurement channel A1:	The gauge is automatically activated when the VGC094 is turned on. The switch-on behavior is then controlled by measuring channel A1.
⇒ By hotstart and measurement channel A2:	The gauge is automatically activated when the VGC094 is turned on. The switch-on behavior is then controlled by measuring channel A2.
⇒ By hotstart and measurement channel B1:	The gauge is automatically activated when the VGC094 is turned on. The switch-on behavior is then controlled by measuring channel B1.
⇒ By hotstart and measurement channel B2:	The gauge is automatically activated when the VGC094 is turned on. The switch-on behavior is then controlled by measuring channel B2.

- ⇒ Previous:
The gauge is activated by pressing the key. It is started in the same state as before the last power cycle.
- ⇒ Previous and by measurement channel A1:
The gauge is started in the same state as before the last power cycle. The switch-on behavior is then controlled by measuring channel A1.
- ⇒ Previous and by measurement channel A2:
The gauge is started in the same state as before the last power cycle. The switch-on behavior is then controlled by measuring channel A2.
- ⇒ Previous and by measurement channel B1:
The gauge is started in the same state as before the last power cycle. The switch-on behavior is then controlled by measuring channel B1.
- ⇒ Previous and by measurement channel B2:
The gauge is started in the same state as before the last power cycle. The switch-on behavior is then controlled by measuring channel B2.

ON threshold

Definition of the ON threshold for the gauge to be activated by a gauge connected to the other measurement channel.

This parameter appears only when the SENSOR ON parameter is set to SENSOR A1, SENSOR A2, SENSOR B1 or SENSOR B2.

You can define a ON threshold with the parameter **THRESHOLD ON** . If the pressure on the relevant measuring channel falls below the ON threshold, the gauge is switched on.

	Value
Row 1	THRESHOLD ON Parameter name
Row 2	5.0E-3 ON threshold



Value **THRESHOLD OFF** must be \geq **THRESHOLD ON** .

Gauge deactivation

Certain gauges can be deactivated by different means.

The parameter values "SENSOR A1", "SENSOR A2", "SENSOR B1" and "SENSOR B2" are only displayed for the available channels.

	Value
Row 1	SENSOR OFF
Row 2	HAND
	SELF
	SENSOR A1
	SENSOR A2
	SENSOR B1
	SENSOR B2

	Value
Parameter name	
⇒ Manual deactivation:	The gauge is deactivated by pressing the key (default).
⇒ Self control:	The gauge deactivates itself when the pressure rises.
⇒ Automatic deactivation by measurement channel A1.	
⇒ Automatic deactivation by measurement channel A2.	
⇒ Automatic deactivation by measurement channel B1.	
⇒ Automatic deactivation by measurement channel B2.	

OFF threshold

Definition of the OFF threshold for the gauge to be deactivated by a gauge connected to the other measurement channel or by itself.

This parameter appears only when the SENSOR OFF parameter is set to SELF, SENSOR A1, SENSOR A2, SENSOR B1, SENSOR B2, HOTSTART + A1, HOTSTART + A2, HOTSTART + B1 or HOTSTART + B2.

You can define an OFF threshold with the parameter **THRESHOLD OFF**. If the pressure on the relevant measuring channel exceeds the OFF threshold, the gauge is switched off.

	Value
Row 1	THRESHOLD OFF
Row 2	6.0E-3



Value **THRESHOLD OFF** must be \geq **THRESHOLD ON**.

5.6.4 General Parameters

GENERAL >

The General parameters group is used for displaying, entering and editing generally applicable system parameters.

Parameters in this group

UNIT	Measurement unit
ANALOG OUTPUT	Analog output
ERROR-RELAY	Error relay
PENNING-UR	Penning underrange
BARGRAPH / GRAPH	Bar graph display
CONTRAST LCD	Contrast adjustment
BACKLIGHT	Backlight
SCREENSAVER	Screensaver
SET DEFAULT	Factory settings
LANGUAGE	Language
END VALUE	Display of measurement range end value
<	One level back

Measurement unit

Unit of measured values, thresholds etc. See Appendix for conversion table (→ 89).

	Value
Row 1	UNIT Parameter name
Row 2	HPASCAL ⇒ hPa
	MBAR ⇒ mBar (default)
	TORR ⇒ Torr (only available if Torr lock is not activated → 50)
	PASCAL ⇒ Pa
	MICRON ⇒ Micron (= 0.001 Torr) (only available if Torr lock is not activated → 50)
	VOLT ⇒ Volt
	AMPERE ⇒ Ampere

Analog output

Output characteristics of the 4 analog outputs.

	Value
Row 1	ANALOG OUTPUT Parameter name
Row 2	OFF ⇒ Turned off (default)
	0...5V ⇒ 0 ... 5 V Direct output of the measuring signals as fast as possible.
	0...10V ⇒ 0 ... 10 V Output of measurement signals scaled and filtered to 0 ... 10 V.
	4...20mA ⇒ 4 ... 20 mA Output of measurement signals scaled and filtered to 4 ... 20 mA.

Error relay

Switching behaviour of the error relay.

	Value
Row 1	<code>ERROR-RELAY</code> Parameter name
Row 2	<code>ALL ERRORS</code> ⇒ Switches for all errors (factory setting)
	<code>no SENSOR ERRORS</code> ⇒ Only unit errors
	<code>SENSOR A1 ERRORS</code> ⇒ Error sensor A1 and unit error
	<code>SENSOR A2 ERRORS</code> ⇒ Error sensor A2 and unit error
	<code>SENSOR B1 ERRORS</code> ⇒ Error sensor A1 and unit error
	<code>SENSOR B2 ERRORS</code> ⇒ Error sensor A2 and unit error

Underrange control

Definition of behaviour in the event of an underrange with Cold Cathode Gauges (Penning underrange control).

There are a number of possible causes of an underrange:

- the pressure in the vacuum system is lower than the measurement range
- the measurement element has not (yet) ignited.
- discharge has failed
- a fault has occurred

Caution

Relay is switching

An underrange can lead to unintended reactions of the connected control system.

Prevent false control signals and messages by disconnecting the sensor and control cables.

	Value
Row 1	<code>PENNING-UR</code> Parameter name
Row 2	<code>DISABLED</code> ⇒ Factory setting. Underrange state is interpreted as an admissible measurement value. UR is displayed. The switching function remains ON.
	<code>ENABLED</code> ⇒ Underrange state is interpreted as an admissible measurement value. UR is displayed. The switching function remains OFF.



If there is a possibility of the pressure in the vacuum system dropping below the measurement range of the gauge, it is advisable to select

`PENNING-UR`
`DISABLED` .

If `PENNING-UR`
`ENABLED` is selected, evaluation of the switching function is suppressed for 10 seconds when the gauge is turned on and each time after an underrange has recurred. During this time, the switching function remains OFF.



Cold cathode measuring circuits for 10^{-11} mbar sometimes require more than 10 seconds for the transition OR to UR and thus lead the switching function being ON for a short time.

Bar graph

In the dot matrix a bar graph or the measured pressure as a function of time ($p = f(t)$) may be shown.

During parameter setting the parameter and the parameter value may be displayed in place of this.

	Value
Row 1 <code>BARGRAPH</code>	Parameter name
Row 2 <code>OFF</code>	⇒ Factory setting.
<code>FULLSCALE</code>	⇒ Bar graph covering full scale range.
<code>FULLSCALE h</code>	⇒ Bar graph covering full scale range, high-level presentation.
<code>FULLSCALE+SP</code>	⇒ Bar graph covering full scale range and setpoint threshold.
<code>DECADE</code>	⇒ Bar graph covering a decade according to current measurement value.
<code>DECADE h</code>	⇒ Bar graph covering a decade according to current measurement value, high-level presentation.
<code>DECADE+SP</code>	⇒ Bar graph covering a decade according to current measurement value and setpoint threshold.
<code>F(0.2s)</code>	⇒ $p = f(t)$, autoscaled, 0.2 seconds / pixel For each measurement, a measurement value is saved in tabular form every 200 ms and the last 100 measurement values (=100 pixel) are shown autoscaled. The represented data string corresponds to a logging duration of 20 seconds.
<code>F(1s)</code>	⇒ $p = f(t)$, autoscaled, 1 second / pixel For each measurement, a measurement value is saved in tabular form every second and the last 100 measurement values (=100 pixel) are shown autoscaled. The represented data string corresponds to a logging duration of 100 seconds.
<code>F(6s)</code>	⇒ $p = f(t)$, autoscaled, 6 seconds / pixel For each measurement, a measurement value is saved in tabular form every 6 seconds and the last 100 measurement values (=100 pixel) are shown autoscaled. The represented data string corresponds to a logging duration of 10 minutes.
<code>F(1min)</code>	⇒ $p = f(t)$, autoscaled, 1 minute / pixel For each measurement, a measurement value is saved in tabular form every minute and the last 100 measurement values (=100 pixel) are shown autoscaled. The represented data string corresponds to a logging duration of 100 minutes.
<code>F(0.5h)</code>	⇒ $p = f(t)$, autoscaled, 30 minutes / pixel For each measurement, a measurement value is saved in tabular form every 30 minutes and the last 100 measurement values (=100 pixel) are shown autoscaled. The represented data string corresponds to a logging duration of 50 hours.

IDENTIFICATION

⇒ For the selected measurement circuit, the plug-in board identification (row 1) and the measuring point name (row 2) are displayed.

e.g.: PI3000
FORELINE

SETPOINTS

⇒ For the selected measurement channel the measuring point name (row 1) and the assigned setpoints (row 2) are displayed.

e.g.: FORELINE
SP 2,4

Contrast

	Value
Row 1	CONTRAST LCD
Row 2	40%
	:
	100%

Parameter name
⇒ Off
Default = 40%
⇒ Full contrast

Backlight

	Value
Row 1	BACKLIGHT
Row 2	40%
	:
	100%

Parameter name
⇒ Off
Default = 40%
⇒ Full brightness

Screensaver

	Value
Row 1	SCREENSAVER
Row 2	OFF
	10 MINUTES
	30 MINUTES
	1 HOUR
	2 HOURS
	8 HOURS
	DARKROOM

Parameter name
⇒ Factory setting
⇒ After 10 minutes
⇒ After 30 minutes
⇒ After 1 hour
⇒ After 2 hours
⇒ After 8 hours
⇒ The backlight is switched off completely after 1 minute. It is activated again by pressing any key.

Default parameter settings

All user parameter settings are replaced by the default values (factory settings).

Caution

Interruption of the current connection

Resetting the parameters to factory settings also resets communication parameters (e.g. transmission rate, Ethernet settings) and can lead to an interruption of the current connection.

Reset parameter to factory setting only if you are sure that no malfunction will cause by an interruption of the current connection.



Loading of the default parameter settings is irreversible.

	Value
Row 1 <code>SET DEFAULT</code>	Parameter name
Row 2 <code>▼+▲ 2s</code>	Press keys at the same time for >2 s to start loading default values
<code>DEFAULTS LOADED</code>	⇒ The default values are loaded (displayed in the default language)

Language

Display language.

	Value
Row 1 <code>LANGUAGE</code>	Parameter name
Row 2 <code>ENGLISH</code>	⇒ English (default)
<code>GERMAN</code>	⇒ German
<code>FRENCH</code>	⇒ French

Display of measurement range end value

Display of underrange or overrange.

	Value
Row 1 <code>END VALUE</code>	Parameter name
Row 2 <code>UR/OR</code>	⇒ When an underrange or overrange occurs UR or OR is displayed (default)
<code>VALUE</code>	⇒ When an underrange or overrange occurs the respective full scale value is displayed

5.6.5 Communication Parameters

COMMUNICATION >

The Communication parameters group is used for displaying, entering and editing communication parameters.

Parameters in this group

BAUDRATE USB

Transmission rate USB interface

BAUDRATE IFxxx

Transmission rate IF300x plug-in board

BAUDRATE RS485

Transmission rate RS485 interface

RS485 ADRESSE

RS485 device address

DHCP (ETH)

Dynamic Host Configuration Protocol (Ethernet)

IP (ETH)

IP address (Ethernet)

SUBNET (ETH)

Subnet mask (Ethernet)

GATEWAY (ETH)

Gateway address (Ethernet)

<

One level back

Transmission rate USB interface

Transmission rate of the USB interface.

	Value
Row 1 BAUDRATE USB	Parameter name
Row 2 9600	⇒ 9600 Baud
19200	⇒ 19200 Baud
38400	⇒ 38400 Baud
57600	⇒ 57600 Baud
115200	⇒ 115200 Baud (default)

Transmission rate IF300x plug-in board

Transmission rate of the IF300x plug-in board.



If the VGC094 is operated with the IF300P Profibus interface plug-in board, the transmission rate must be set to 19200 Baud.

	Value
Row 1 BAUDRATE IFxxx	Parameter name
Row 2 1200	⇒ 1200 Baud
2400	⇒ 2400 Baud
4800	⇒ 4800 Baud
9600	⇒ 9600 Baud (default)
19200	⇒ 19200 Baud

Transmission rate RS485 interface

Transmission rate of the RS485 interface.

	Value
Row 1	BAUDRATE RS485 Parameter name
Row 2	9600 ⇒ 9600 Baud
	19200 ⇒ 19200 Baud
	38400 ⇒ 38400 Baud
	57600 ⇒ 57600 Baud
	115200 ⇒ 115200 Baud (default)

RS485 address

RS485 device address.

	Value
Row 1	RS485 ADDRESS Parameter name
Row 2	1 ⇒ Default
	⋮
	24 Adjustable from 1 ... 24

DHCP

Dynamic Host Configuration Protocol. Allows the automatic allocation of the network configuration (IP address, subnet mask, gateway) to clients through the server.

	Value
Row 1	DHCP (ETH) Parameter name
Row 2	OFF ⇒ The IP address, subnet mask, and gateway must be configured manually (factory setting)
	ON ⇒ The IP address, subnet mask, and gateway are set automatically, but cannot be changed.

IP address

IP address.

	Value
Row 1	IP (ETH) Parameter name
Row 2	xxx.xxx.xxx.xxx ⇒ Can only be changed if DHCP is set to "OFF".

Subnet mask

Subnet mask.

	Value
Row 1	SUBNET (ETH) Parameter name
Row 2	xxx.xxx.xxx.xxx ⇒ Can only be changed if DHCP is set to "OFF".

Gateway address

Gateway address.

	Value
Row 1 GATEWAY (ETH)	Parameter name
Row 2 xxx.xxx.xxx.xxx	⇒ Can only be changed if DHCP is set to "OFF".

5.6.6 Plug-In Boards Parameters

PLUG-IN BOARDS >

The Plug-In Boards parameters group is used for displaying plug-in boards parameters.

Parameters in this group

IDENTIFICATION

Identification of the plug-in board

HARDWARE VERSION

Hardware version of the plug-in board

SOFTWARE VERSION

Software version of the plug-in board

SOFTWARE UPDATE

Software update of the plug-in board

<

One level back

Identification

	Value
Row 1 IDENTIFIKATION	Identification of the plug-in board
Row 2 IF500PN	⇒ Type of the plug-in board

Hardware version

	Value
Row 1 HARDWARE VERSION	Hardware version of the plug-in board
Row 2 V1.00	⇒ Display of the hardware version for plug-in boards of the latest generation
-	⇒ For plug-in boards of the old generation the hardware version is not displayed

Software version

	Value
Row 1 SOFTWARE VERSION	Software version of the plug-in board
Row 2 V1.00	⇒ Display of the software version for plug-in boards of the latest generation
-	⇒ For plug-in boards of the old generation the software version is not displayed

Software update

	Value
Row 1 SOFTWARE UPDATE	Software update of the plug-in board via USB stick
Row 2 √+√2s	⇒ Update of the software only for plug-in boards of the latest generation

5.6.7 Data Logger Mode

DATA LOGGER >

The data logger group is used for

- recording measurement data on a USB memory stick (interface type A on the front of the VGC094)
- deleting recorded measurement data from the USB memory stick



This group is only available when a USB memory stick formatted for the FAT file system (FAT32) is plugged in. Use a max. 32 GB memory stick.



Not all USB memory sticks are automatically recognized by the VGC094, as they (in particular cheaper brands) do not always conform to USB standard requirements. Try a different memory stick before contacting your nearest INFICON service center.

Parameters in this group

MODUS	Start of data recording
DATE	Current date
TIME	Current time
INTERVAL	Recording interval
DEC-SEPARATOR	Decimal separator
FILENAME	File name
START / STOP	Start / stop display
CLEAR	Deletion of files with displayed measurement data

Modus

	Value
Row 1	MODUS Recording mode
Row 2	MANUELL ⇒ Manual start via START / STOP (default)
	AUTOMATISCH ⇒ Automatic start by inserting a USB memory stick. Disconnect the USB memory stick to stop the recording, or use parameter ▼ TO STOP.

Date

	Value
Row 1	DATE Current date in the format YYYY-MM-DD
Row 2	2020-04-25 ⇒ e.g. 2020-04-25

Time

	Value
Row 1	TIME Current time in the format hh:mm [24 h]
Row 2	15:45 ⇒ e.g. 15:45

Interval

Data logging interval.

	Value
Row 1	INTERVAL
Row 2	1s ⇒ Recording interval 1/s
	10s ⇒ Recording interval 1/10 s
	30s ⇒ Recording interval 1/30 s
	1min ⇒ Recording interval 1/60 s
	1% DEVIATION ⇒ Recording interval: In the event of measurement value changes $\geq 1\%$
	5% DEVIATION ⇒ Recording interval: In the event of measurement value changes $\geq 5\%$

Decimal separator

Decimal separator for measurement values in the measurement data file.



Further processing of recorded data (e.g. with Excel): Pay attention to the corresponding decimal separator (comma or dot).

	Wert
Row 1	DEC-SEPARATOR
Row 2	, (COMMA) ⇒ Decimal comma
	. (DOT) ⇒ Decimal point

File name

	Value
Row 1	FILENAME Name of the measurement data file, max. 7 digits
Row 2	DATALOG ⇒ File ending: CSV

After entering the 8th digit the display stops flashing. The name of the data file is saved and the unit is in the read mode again.



Is the file name shorter than 8 digits, a blank space must be set to each remaining digit.

Start / Stop

Starting / stopping measurement value record.



The symbol flashes during measurement data record.

	Value
Row 1	START/STOP
Row 2	▲ TO START ⇒ Press key to start data record: Data record is running, display has changed to ▼ TO STOP and the symbol is blinking.
	▼ TO STOP ⇒ Press key to stop data record: Data record is stopped, display has changed to ▲ TO START and the symbol is blinking.

Delete

For deleting all measurement data files (extension CSV) from the USB memory stick.

	Value
Row 1 CLEAR	
Row 2 ▼+▲	Press keys at the same time to delete files
RUNNING	⇒ CSV files are being deleted
DONE	⇒ CSV files have been deleted

5.6.8 Setup Mode

SETUP >

This group is used for

- saving all parameters on a USB memory stick (interface type A on the front of the VGC094)
- loading all parameters from a USB memory stick onto the VGC094
- formatting a USB memory stick
- deleting files with saved parameters from the USB memory stick



This group is only available when a USB memory stick formatted for the FAT file system (FAT32) is plugged in. Use a max. 32 GB memory stick.

Parameters in this group

SAVE TO

Saving all parameters

RESTORE FROM

Loading all parameters onto the VGC094

FORMAT

Formatting USB memory stick (FAT32)

CLEAR

Deletion of files with saved parameters

<

One level back

Saving a parameter

Saving all parameters of the VGC094 to a USB memory stick (file ending: CSV).



The threshold values and the offset are saved in mBar or hPa.

	Value
Row 1 SAVE TO	
Row 2 SETUP00.CSV	⇒ File name on the USB memory stick: SETUP00.CSV
:	
SETUP99.CSV	⇒ File name on the USB memory stick: SETUP99.CSV
RUNNING	⇒ CSV file is being saved
DONE	⇒ Saving completed

Loading a parameter

Loading all parameters from a USB memory stick onto the VGC094.

	Value
Row 1	RESTORE FROM
Row 2	SETUP00.CSV
	:
	SETUP99.CSV
	RUNNING
	DONE
	ERROR

⇒ File name on the USB memory stick: SETUP00.CSV

⇒ File name on the USB memory stick: SETUP99.CSV

⇒ CSV file is being loaded



⇒ Loading completed

⇒ Error occurred

Formatting

Formatting USB memory stick.

	Value
Row 1	FORMAT
Row 2	▼+▲
	RUNNING
	DONE

Press   keys at the same time to start formatting



⇒ Formatting in progress

⇒ Formatting completed

Delete

Deleting all parameter files (ending CSV) from the USB memory stick.

	Value
Row 1	CLEAR
Row 2	▼+▲
	RUNNING
	DONE

Press   keys at the same time to delete files

⇒ CSV files are being deleted

⇒ CSV files have been deleted

5.6.9 Test Parameters

TEST >

The Test parameter group is used for displaying the firmware version, entering and editing special parameter values, and for running test programs.



The group is only available if

- the key was pressed while the unit was turned on, or
- the key was pressed for 5 s while is displayed.

Parameters in this group

SOFTWARE VERSION	Firmware version
HARDWARE VERSION	Hardware version
MAC ADDRESS	MAC address
RUNHOURS	Operating hours
WATCHDOG	Watchdog control
TORR-LOCK	Torr lock
KEY-LOCK	Keylock
FLASH TEST	FLASH test (program memory)
EEPROM TEST	EEPROM test (parameter memory)
DISPLAY TEST	Display test
RELAY TEST	Relay test
RECALIBRATION	Re-calibration
<	One level back

The parameters in this group are available for all gauges.

Firmware version

The firmware version (program version) is displayed.

		Version
Row 1	SOFTWARE VERSION	This information is helpful when contacting INFICON
Row 2	1.00 [4664]	

Hardware version

The hardware version is displayed.

		Version
Row 1	HARDWARE VERSION	This information is helpful when contacting INFICON
Row 2	1.00	

MAC address

The MAC address is displayed.

		Value
Row 1	MAC ADDRESS	The address is displayed without any separators (e.g. 00-A0-41-0A-00-08)
Row 2	00A0410A0000	

Operating hours

The operating hours are displayed.

	Value
Row 1	RUNHOURS
Row 2	24 h

Watchdog control

Behaviour of the system control (watchdog control) in the event of an error.

	Setting
Row 1	WATCHDOG
Row 2	AUTO
	OFF

⇒ The system automatically acknowledges error messages of the watchdog after 2 s (factory setting)

⇒ Error messages of the watchdog have to be acknowledged by the operator

Torr lock

The measurement unit Torr can be suppressed in the corresponding parameter setting (→ 37).

	Setting
Row 1	TORR-LOCK
Row 2	OFF
	ON

⇒ Measurement unit Torr available (factory setting)

⇒ Measurement unit Torr not available

Keylock

The keylock function prevents inadvertent entries in the parameter mode and thus malfunctions.

	Setting
Row 1	KEY-LOCK
Row 2	OFF
	ON



⇒ Keylock function disabled (factory setting)

⇒ Keylock function enabled

FLASH test

Test of the program memory.

	Test sequence
Row 1	FLASH TEST
Row 2	▼+▲
	RUN
	PASS
	ERROR

Press   keys at the same time to start test

⇒ Test in progress (very briefly)

⇒ Test completed, no error found. After the test, an 8-digit checksum (e.g. 0x12345678) is displayed.

⇒ Test completed, error found. After the test, an 8-digit checksum (e.g. 0x12345678) is displayed. If the error persists after repeating the test, please contact your nearest INFICON service center.

EEPROM test

Test of the parameter memory.

		Test sequence
Row 1		Press keys at the same time to start test ⇒ Test in progress. ⇒ Test completed, no error found. ⇒ Test completed, error found. If the error persists after repeating the test, please contact your nearest INFICON service center.
Row 2		

Display test

Test of the display.

		Test sequence
Row 1		Press keys at the same time to start test ⇒ After starting the test, all display elements are lit at the same time for 10 s.
Row 2		

Relay test

Test of the unit relays. The test program tests their switching function.

Caution



The relays switch irrespective of the pressure.

Starting a test program may cause unwanted effects in connected control systems.

Disconnect all sensor and control system lines to ensure that no control commands or messages are triggered by mistake.

The relays switch on and off cyclically. The switching operations are indicated optically and are also clearly audible.

The switching function contacts are connected to the *control* connector on the rear of the unit (→ 17). Check their function with an ohmmeter.

		Test sequence
Row 1	RELAY TEST	
Row 2	▼+▲	Press   keys at the same time to start test
	OFF	⇒ All relays deactivated
	REL1 ON	⇒ Switching function relay 1
	REL1 OFF	⇒ Switching function relay 1
	REL2 ON	⇒ Switching function relay 2
	REL2 OFF	⇒ Switching function relay 2
	⋮	

Re-calibration

Date of the next re-calibration.

		Test sequence
Row 1	RECALIBRATION	
Row 2	2020-12-01	Date of the next re-calibration
<p>Once the configured date is reached, the following information message will be displayed periodically.</p>		
Row 1	RECALIBRATION	
Row 2	REQUIRED !	

6 Communication Protocol (Serial Interface)

The serial interfaces (RS485, USB, Ethernet, IF300A / B / C) are used for communication between the VGC094 and a computer. A terminal can be connected for test purposes.

RS232C interface

RS232C communication requires one of the interface and relay cards provided for the VGC094 (IF300A, IF300B, →  [1]).

Profibus interface

The VGC094 can be equipped with a Profibus interface. This requires the corresponding interface relay card IF300P in slot C of the VGC094. This card has the standard Profibus interface and five relay outputs (switching functions and error status).

Description of the function and programming instructions →  [1], [5].

It should be noted that for commands containing channel-specific parameters, the number of values must match the number of channels.

Example: Transmit: **FL** [,a,b,c,d]

6.1 Data Transmission

The data transmission is bi-directional, i.e. data and control commands can be transmitted in either direction.

Data format

1 start bit, 8 data bits, no parity bit, 1 stop bit, no hardware handshake

Definitions

The following abbreviations and symbols are used:

Symbol	Meaning		
HOST	Computer or terminal		
[...]	Optional elements		
ASCII	American Standard Code for Information Interchange		
		Dez	Hex
<ETX>	END OF TEXT (CTRL C) Reset the interface	3	03
<CR>	CARRIAGE RETURN Go to beginning of line	13	0D
<LF>	LINE FEED Advance by one line	10	0A
<ENQ>	ENQUIRY Request for data transmission	5	05
<ACK>	ACKNOWLEDGE Positive report signal	6	06
<NAK>	NEGATIVE ACKNOWLEDGE Negative report signal	21	15
<ESC>	ESCAPE	27	1B

"Transmit": Data transfer from HOST to VGC094

"Receive": Data transfer from VGC094 to HOST

Flow Control

After each ASCII string, the HOST must wait for a report signal (<ACK><CR><LF> or <NAK> <CR><LF>).

The input buffer of the HOST must have a capacity of at least 64 bytes.

6.2 Communication Protocol

Transmission format

Messages are transmitted to the VGC094 as ASCII strings in the form of mnemonic operating codes and parameters. All mnemonics comprise three ASCII characters.

Spaces are ignored. <ETX> (CTRL C) clears the input buffer in the VGC094.



With RS485 half duplex connection no LINE FEED (<LF>) should be sent (data collision on the bus).

The use of LINE FEED is generally permitted with the other interfaces (USB, Ethernet, IF300A / B / C). For time reasons, however, it should not be used.

Transmission protocol

HOST	VGC094	Explanation
Mnemonics [and parameters] <CR>[<LF>]	—————> —————>	Receives message with "end of message"
	<————— <ACK><CR><LF>	Positive acknowledgment of a received message

Reception format

When requested with a mnemonic instruction, the VGC094 transmits the measurement data or parameters as ASCII strings to the HOST.

<ENQ> must be transmitted to request the transmission of an ASCII string. Additional strings, according to the last selected mnemonic, are read out by repetitive transmission of <ENQ>.

If <ENQ> is received without a valid request, the ERROR word is transmitted.

Reception protocol

HOST	VGC094	Explanation
Mnemonics [and parameters] <CR>[<LF>]	—————> —————>	Receives message with "end of message"
	<————— <ACK><CR><LF>	Positive acknowledgment of a received message
<ENQ>	—————>	Requests to transmit data
	<————— Measurement values or parameters <————— <CR><LF>	Transmits data with "end of message"
	:	:
<ENQ>	—————>	Requests to transmit data
	<————— Measurement values or parameters <————— <CR><LF>	Transmits data with "end of message"

Error processing

The strings received are verified in the VGC094. If an error is detected, a negative acknowledgment <NAK> is output.

Error recognition protocol

HOST	VGC094	Explanation
Mnemonics [and parameters] <CR>[<LF>]	—————> —————>	Receives message with "end of message"
	***** Transmission or programming error *****	
	<—— <NAK><CR><LF>	Negative acknowledgment of a received message
Mnemonics [and parameters] <CR>[<LF>]	—————> —————>	Receives message with "end of message"
	<————— <ACK><CR><LF>	Positive acknowledgment of a received message

6.3 Mnemonics

	→ 
ADC	A/D converter test 78
AOM	Analog Output Mode 68
AYT	Are you there? 82
BAI	Transmission rate USB 75
BAL	Backlight 68
BAR	Transmission rate RS485 74
BAU	Transmission rate IFxxx 74
CAX	Leakage current compensation for channels A1 / A2 61
CBx	Leakage current compensation for channels B1 / B2 61
CDA	Calibration date 78
CID	Channel identifier 62
COM	Continuous mode of measurement values 56
COR	Correction factor other gas types 62
DAT	Date 77
DCB	Display control bar graph 69
DCC	Display control contrast 70
DCS	Display control screensave 70
DIS	Display test 79
EEP	EEPROM test 79
EPR	FLASH test 79
ERA	Error relay allocation 71
ERR	Error status 56
ETH	Ethernet configuration 75
EVA	Measurement range end value 71
FIL	Measurement value filter 63
GAS	Gas type correction 63
HDW	Hardware version 79
IOT	I/O test 80
LCM	Start / stop data logger 77
LNG	Language (display) 71
LOC	Keylock 80
MAC	Ethernet MAC address 81
NAD	Node (device) address for RS485 76
PAn	Measurement data and status for channels A1 / A2 57
PBn	Measurement data and status for channels B1 / B2 57
PNR	Firmware version 81
PRX	Measurement data and status for all gauges 58
PUC	Penning underrange control 72
RES	Reset 58
RHR	Operating hours 81
SAV	Save parameters (EEPROM) 72
SAX	Sensor control slot A 64
SBx	Sensor control slot B 65
SCM	Save / load parameters (USB) 78
SEN	Measurement circuit on/off 59
SME	Show me 83
SPA	Sensor control slot A 66
SPB	Sensor control slot B 67
SPS	Switching function status 60
SPx	Switching function 1 ... 4 60
TID	Plug-in boards identification 59

TIM	Time	77
TKB	Operator key test	81
TLC	Torr lock	82
TMP	Inner temperature of the unit	83
UNI	Pressure unit	73
VBT	Battery voltage	83
WDT	Watchdog control	82

6.4 Measurement Mode

6.4.1 COM - Continuous Output of Measurement Values

Transmit: **COM** [,a] <CR>[<LF>]

	Description
a	Mode, a = 0 → 100 ms 1 → 1 s (default) 2 → 1 minute

Receive: <ACK><CR><LF>

This is immediately followed by continuous output of the measured values at the desired time interval.

Receive: b,x.xEsxx,b,x.xEsxx,b,x.xEsxx,b,x.xEsxx <CR><LF>

	Description
b	Status of the four measurement channels (A1, A2, B1, B2), b = 0 → Measurement data okay 1 → Underrange 2 → Overrange 3 → Sensor error 4 → Sensor off 5 → No hardware
x.xEsxx	Measurement value measurement channel ¹⁾ [in current pressure unit] (s = sign)



¹⁾ Values always in exponential format.

6.4.2 ERR - Error Status

Transmit: **ERR** <CR>[<LF>] Error status

Receive: <ACK><CR><LF>

Transmit: <ENQ>

Receive: aaaa <CR><LF>

	Description
aaaa	Error status, aaaa = 0000 → No error 1000 → Controller error (see display on front panel) 0100 → Hardware not installed 0010 → Inadmissible parameter 0001 → Syntax error



The error status is cleared when readout, but is reset immediately if the error remains or continues.

6.4.3 PA1 / PA2 - Measurement Data Channels A1 / A2

Transmit: **PAn** <CR>[<LF>]

	Description
n	Measurement value, n = 1 → Measurement channel A1 2 → Measurement channel A2

Receive: <ACK><CR><LF>

Transmit: <ENQ>

Receive: a,x.xEsxx <CR><LF>

	Description
a	Status, a = 0 → Measurement data okay 1 → Underrange 2 → Overage 3 → Measuring point error (sensor error) 4 → Measuring point switched off 5 → No hardware
x.xEsxx	Measurement value [in current pressure unit] (s = sign)

6.4.4 PB1 / PB2 - Measurement Data Channels B1 / B2

Senden: **PBn** <CR>[<LF>]

	Description
n	Measurement value, n = 1 → Measurement channel B1 2 → Measurement channel B2

Receive: <ACK><CR><LF>

Transmit: <ENQ>

Receive: a,x.xEsxx <CR><LF>

	Description
a	Status, a = 0 → Measurement data okay 1 → Underrange 2 → Overage 3 → Measuring point error (sensor error) 4 → Measuring point switched off 5 → No hardware
x.xEsxx	Measurement value [in current pressure unit] (s = sign)

6.4.5 PRX - Measurement Data Channels A1, A2, B1, B2

Transmit: **PRX** <CR><LF>
 Receive: <ACK><CR><LF>
 Transmit: <ENQ>
 Receive: a,x.xEsxx,a,x.xEsxx,a,x.xEsxx,a,x.xEsxx <CR><LF>

	Description
a	Status measurement channel, a = 0 → Measurement data okay 1 → Underrange 2 → Overrange 3 → Measuring point error (sensor error) 4 → Measuring point switched off 5 → No hardware
x.xEsxx	Measurement value gauge [in current pressure unit] (s = sign)

6.4.6 RES - Reset

Transmit: **RES** [,a] <CR><LF>

	Description
a	a = 1 → Re-start and read out the pending error messages.

Receive: <ACK><CR><LF>
 Transmit: <ENQ>

Receive: b[,b][,b][...] <CR><LF>

	Description
b	List of all current error messages, b = 0 → No error 1 → Watchdog has triggered 3 → FLASH error 5 → EEPROM error

6.4.7 SEN - Switching Measurement Circuit On/Off

Transmit: **SEN** [,a,b,c,d] <CR>[<LF>]

	Description
a	Measurement circuit A1, a = 0 → No change 1 → Turn measurement circuit off 2 → Automatic 3 → Turn measurement circuit on
b	Measurement circuit A2
c	Measurement circuit B1
d	Measurement circuit B2

Receive: <ACK><CR><LF>

Transmit: <ENQ>

Receive: a,b,c,d <CR><LF>

	Description
a	Status measurement circuit A1, a = 0 → No measurement circuit 1 → Gauge turned off 2 → Automatic 3 → Gauge turned on
b	Status measurement circuit A2
c	Status measurement circuit B1
d	Status measurement circuit B2

6.4.8 TID - Measurement Circuit Identification

Plug-in board identification.

Transmit: **TID** <CR>[<LF>]

Receive: <ACK><CR><LF>

Transmit: <ENQ>

Receive: a,b,c <CR><LF>

	Description
a, b	PI300D PI300DN PE300Dx9 CP300x9 CP300x10 CP300T11 CP300T11L NO BOARD
c	IF300x ¹⁾ NO BOARD

¹⁾ The IF300 plug-in boards (IF300A / B / C / P) have the same identification and cannot be distinguished.

6.5 Switching Function Parameters

6.5.1 SPS - Switching Function Status

Transmit: **SPS** <CR>[<LF>]
 Receive: <ACK><CR><LF>
 Transmit: <ENQ>
 Receive: a,b,c,d,e,f <CR><LF>

	Description
a	Status switching function 1, a = 0 → Off 1 → On
b	Status switching function 2
c	Status switching function 3
d	Status switching function 4
e	Switching function A
f	Switching function B

6.5.2 SP1 ... SP4 - Switching Function 1 ... 4

Transmit: **SPx** [x.xEsxx,y.yEsyy,a,b] <CR>[<LF>]

	Description
x	Switching function, x = 1 → Switching function 1 2 → Switching function 2 3 → Switching function 3 4 → Switching function 4
x.xEsxx	Lower threshold [in current pressure unit] (s = sign)
y.yEsyy	Upper threshold [in current pressure unit] (s = sign)
a	Switching function assignment, a = 0 → Turned off 1 → Measurement channel A1 2 → Measurement channel A2 3 → Measurement channel B1 4 → Measurement channel B2 5 → Turned on
b	ON-Timer (0 ... 100 seconds)

Receive: <ACK><CR><LF>
 Transmit: <ENQ>
 Receive: x.xEsxx,y.yEsyy,a,b <CR><LF>

	Description
x.xEsxx	Lower threshold [in current pressure unit] (s = sign)
y.yEsyy	Upper threshold [in current pressure unit] (s = sign)
a	Switching function assignment
b	ON-Timer

6.6 Gauge Parameters

6.6.1 CA1, CA2 - Leakage Current Compensation

Leakage current compensation for measurement channels A1 and A2.

Transmit: **CAx** [,a,b] <CR>[<LF>]

Receive: <ACK><CR><LF>

Transmit: <ENQ>

Receive: a,b <CR><LF>

	Description
a	Leakage current compensation 0 → Off (default) 1 → On 2 → Determine value automatically and activate leakage current compensation.
b	Compensation value (used for writing only if a = 1)

6.6.2 CB1, CB2 - Leakage Current Compensation

Leakage current compensation for measurement channels B1 and B2.

Transmit: **CBx** [,a,b] <CR>[<LF>]

Receive: <ACK><CR><LF>

Transmit: <ENQ>

Receive: a,b <CR><LF>

	Description
a	Leakage current compensation 0 → Off (default) 1 → On 2 → Determine value automatically and activate leakage current compensation.
b	Compensation value (used for writing only if a = 1)

6.6.3 CID - Measuring Point Name

Name of the measuring point (max. 8 characters). Only capital letters, numbers and underlines permitted.

Transmit: **CID** [,aaaaaaa,bbbbbbb,ccccccc,ddddddd] <CR><LF>

	Description
aaaaaaa	Name of measurement channel A1
bbbbbbb	Name of measurement channel A2
ccccccc	Name of measurement channel B1
ddddddd	Name of measurement channel B2

Receive: <ACK><CR><LF>

Transmit: <ENQ>

Receive: aaaaaaa,bbbbbbb,ccccccc,ddddddd <CR><LF>

	Description
aaaaaaa	Name of measurement channel A1
bbbbbbb	Name of measurement channel A2
ccccccc	Name of measurement channel B1
ddddddd	Name of measurement channel B2

6.6.4 COR - Correction factor

Gas type correction factor for measurement channels A1, A2, B1 and B2.

Transmit: **COR** [,a.aa,b.bb,c.cc,d.dd] <CR><LF>

	Description
a.aa	Correction factor for measurement channel A1, adjustable in the range 0.20 ... 8.00
b.bb	Correction factor for measurement channel A2
c.cc	Correction factor for measurement channel B1
d.dd	Correction factor for measurement channel B2

Receive: <ACK><CR><LF>

Transmit: <ENQ>

Receive: a.aa,b.bb,c.cc,d.dd <CR><LF>

	Description
a.aa	Correction factor for measurement channel A1
b.bb	Correction factor for measurement channel A2
c.cc	Correction factor for measurement channel B1
d.dd	Correction factor for measurement channel B2

6.6.5 **FIL** - Measurement Value Filter

Transmit: **FIL** [,a,b,c,d] <CR>[<LF>]

	Description
a	Filter measurement channel A1, a = 0 → Filter OFF 1 → f = 100 Hz ¹⁾ 2 → f = 10 Hz ¹⁾ (default) 3 → f = 1 Hz ¹⁾ 4 → f = 0.1 Hz ¹⁾
b	Filter measurement channel A2
c	Filter measurement channel B1
d	Filter measurement channel B2

¹⁾ The specified frequency is the cut-off frequency of the filter.

Receive: <ACK><CR><LF>

Transmit: <ENQ>

Receive: a,b,c,d <CR><LF>

	Description
a	Filter measurement channel A1
b	Filter measurement channel A2
c	Filter measurement channel B1
d	Filter measurement channel B2

6.6.6 **GAS** - Gas Type Correction

Gas type correction for measurement channels A1, A2, B1 and B2.

Transmit: **GAS** [,a,b,c,d] <CR>[<LF>]

Receive: <ACK><CR><LF>

Transmit: <ENQ>

Receive: a,b,c,d <CR><LF>

	Description
a	Gas type correction for measurement channel A1 0 → Nitrogen / air 1 → Helium 2 → Neon 3 → Argon 4 → Krypton 5 → Xenon 6 → Hydrogen 7 → other gas
b	Gas type correction for measurement channel A2
c	Gas type correction for measurement channel B1
d	Gas type correction for measurement channel B2

6.7 Gauge Control Group

6.7.1 SA1, SA2 - Gauge Control Slot A

Gauge control for measuring channels A1 and A2.

Transmit: **Sax** [,a,b,c.ccEscc,d.ddEsdd] <CR>[<LF>]

Receive: <ACK><CR><LF>

Transmit: <ENQ>

Receive: a,b,c.ccEscc,d.ddEsdd <CR><LF>

	Description
a	Gauge activation, a =
	0 → Manual (default)
	1 → Hot start
	2 → By measurement channel A1
	3 → By measurement channel A2
	4 → By measurement channel B1
	5 → By measurement channel B2
	6 → Hotstart + A1
	7 → Hotstart + A2
	8 → Hotstart + B1
	9 → Hotstart + B2
	10 → Previous
	11 → Previous + A1
	12 → Previous + A2
	13 → Previous + B1
	14 → Previous + B2
b	Gauge deactivation, b =
	0 → Manual (default)
	1 → Self control
	2 → By measurement channel A1
	3 → By measurement channel A2
	4 → By measurement channel B1
	5 → By measurement channel B2
c.ccEscc	ON threshold in current pressure unit (s = sign)
d.ddEsdd	OFF threshold in current pressure unit (s = sign)

6.7.2 SB1, SB2 - Gauge Control Slot B

Gauge control for measuring channels B1 and B2.

Transmit: **SBx** [,a,b,c.ccEscc,d.ddEsdd] <CR>[<LF>]

Receive: <ACK><CR><LF>

Transmit: <ENQ>

Receive: a,b,c.ccEscc,d.ddEsdd <CR><LF>

	Description
a	Gauge activation, a =
	0 -> Manual (default)
	1 -> Hot start
	2 -> Via measurement channel A1
	3 -> Via measurement channel A2
	4 -> Via measurement channel B1
	5 -> Via measurement channel B2
	6 -> Hotstart + A1
	7 -> Hotstart + A2
	8 -> Hotstart + B1
	9 -> Hotstart + B2
	10 -> Previous
	11 -> Previous + A1
	12 -> Previous + A2
	13 -> Previous + B1
	14 -> Previous + B2
b	Gauge deactivation, b =
	0 -> Manual (default)
	1 -> Self control
	2 -> Via measurement channel A1
	3 -> Via measurement channel A2
	4 -> Via measurement channel B1
	5 -> Via measurement channel B2
c.ccEscc	ON threshold in current pressure unit (s = sign)
d.ddEsdd	OFF threshold in current pressure unit (s = sign)

6.7.3 SPA - Gauge Control Slot A

Gauge control for measuring channels A1 and A2. Both channels are controlled simultaneously.



To use all VGC094 control options, we recommend using the commands **SA1** and **SA2** (→  64).

Transmit: **SPA** [a.aEsaa,b.bEsbb,c] <CR>[<LF>]

Receive: <ACK><CR><LF>

Transmit: <ENQ>

Receive: a.aEsaa,b.bEsbb,c <CR><LF>

	Description
a.aEsaa	ON threshold in current pressure unit 1.0E-11 ... 9.9E+3 mbar (s = sign)
b.bEsbb	OFF threshold in current pressure unit 1.0E-11 ... 9.9E+3 mbar (s = sign)
c	Measurement channel assignment, c = 0 → No assignment 1 → Measurement channel A1 2 → Measurement channel A2 3 → Measurement channel B1 4 → Measurement channel B2 5 → Measurement channel A1 ¹⁾ 6 → Measurement channel A2 ¹⁾ 7 → Measurement channel B1 ¹⁾ 8 → Measurement channel B2 ¹⁾ 9 → complex ²⁾ (read only)

¹⁾ Self control with switch-on delay. The gauge is switched on via the selected measuring channel, but switches itself off. The self-monitoring is only enabled after a delay time of approx. 10 s.

²⁾ If the control set with the SA1 and SA2 commands cannot be mapped in the SPA command, this is indicated with parameter value c=9 reading.

6.7.4 SPB - Gauge Control Slot B

Gauge control for measuring channels B1 and B2. Both channels are controlled simultaneously.



To use all VGC094 control options, we recommend using the commands **SB1** and **SB2** (→ [65](#)).

Transmit: **SPB** [,a.aEsaa,b.bEsbb,c] <CR>[<LF>]

Receive: <ACK><CR><LF>

Transmit: <ENQ>

Receive: a.aEsaa,b.bEsbb,c <CR><LF>

	Description
a.aEsaa	ON threshold in current pressure unit 1.0E-11 ... 9.9E+3 mbar (s = sign)
b.bEsbb	OFF threshold in current pressure unit 1.0E-11 ... 9.9E+3 mbar (s = sign)
c	Measurement channel assignment, c = 0 → No assignment 1 → Measurement channel A1 2 → Measurement channel A2 3 → Measurement channel B1 4 → Measurement channel B2 5 → Measurement channel A1 ¹⁾ 6 → Measurement channel A2 ¹⁾ 7 → Measurement channel B1 ¹⁾ 8 → Measurement channel B2 ¹⁾ 9 → complex ²⁾ (read only)

- 1) Self control with switch-on delay. The gauge is switched on via the selected measuring channel, but switches itself off. The self-monitoring is only enabled after a delay time of approx. 10 s.
- 2) If the control set with the SB1 and SB2 commands cannot be mapped in the SPB command, this is signalled when reading with the parameter value c=9.

6.8 General Parameters

6.8.1 AOM - Analog Output Mode

Transmit: **AOM** [,a] <CR>[<LF>]

	Description
a	Analog Output mode, a = 0 → Off (default) 1 → 0 ... 5 V 2 → 0 ... 10 V 3 → 4 ... 20 mA

Receive: <ACK><CR><LF>

Transmit: <ENQ>

Receive: x <CR><LF>

	Description
a	Analog Output mode

6.8.2 BAL - Backlight

Transmit: **BAL** [,a] <CR>[<LF>]

	Description
a	Backlight in percent, a = 0 ... 100 (default = 40%) 100% is full brightness

Receive: <ACK><CR><LF>

Transmit: <ENQ>

Receive: a <CR><LF>

	Description
a	Backlight

6.8.3 DCB - Display Control Bar Graph

Transmit: **DCB** [,a,b] <CR>[<LF>]

	Description
a	Measurement channel, a = 0 → Measurement channel A1 1 → Measurement channel A2 2 → Measurement channel B1 3 → Measurement channel B2
b	Bar graph display, b = 0 → Off (default) 1 → Bar graph covering full scale range 2 → Bar graph covering full scale range and setpoint threshold 3 → Bar graph covering a decade according to current measurement value 4 → Bar graph covering a decade according to current measurement value and setpoint threshold 5 → $p = f(t)$, auto-scaled, 0.2 seconds / pixel For each measurement channel, a measurement value is stored in a table every 200 ms and the last 100 measurement values (=100 pixels) are displayed autoscaled. The data string displayed corresponds to a logging duration of 20 seconds. 6 → $p = f(t)$, auto-scaled, 1 second / pixel For each measurement channel, a measurement value is stored in a table every second and the last 100 measurement values (=100 pixels) are displayed auto-scaled. The data string displayed corresponds to a logging duration of 100 seconds. 7 → $p = f(t)$, auto-scaled, 6 seconds / pixel For each measurement channel, a measurement value is stored in a table every 6 seconds and the last 100 measurement values (=100 pixels) are displayed autoscaled. The data string displayed corresponds to a logging duration of 10 minutes. 8 → $p = f(t)$, auto-scaled, 1 minute / pixel For each measurement channel, a measurement value is stored in a table every minute and the last 100 measurement values (=100 pixels) are displayed autoscaled. The data string displayed corresponds to a logging duration of 100 minutes. 9 → $p = f(t)$, auto scaled, 30 minutes / Pixel For each measurement channel, a measurement value is stored in a table every 30 minutes and the last 100 measurement values (=100 pixels) are displayed autoscaled. The data string displayed corresponds to a logging duration of 50 hours. 10 → For the selected measuring channel, the type of the plug-in board and the name of the measuring point is displayed. 11 → For the selected measuring channel, the name of the measuring point and the assigned switching points are displayed.

Receive: <ACK><CR><LF>
 Transmit: <ENQ>
 Receive: a,b <CR><LF>

	Description
a	Measurement channel
b	Bar graph display

6.8.4 DCC - Display Control Contrast

Transmit: **DCC** [,a] <CR>[<LF>]

	Description
a	Contrast in percent, a = 0 ... 100 (default = 40%) 100% = full contrast

Receive: <ACK><CR><LF>
 Transmit: <ENQ>
 Receive: a <CR><LF>

	Description
a	Contrast

6.8.5 DCS - Display Control Screensave

Transmit: **DCS** [,a] <CR>[<LF>]

	Description
a	Screensave, a = 0 -> Off (default) 1 -> After 10 minutes 2 -> After 30 minutes 3 -> After 1 hour 4 -> After 2 hours 5 -> After 8 hours 6 -> Switches the backlight off completely after 1 minute

Receive: <ACK><CR><LF>
 Transmit: <ENQ>
 Receive: a <CR><LF>

	Description
a	Screensave

6.8.6 ERA - Error Relay Allocation

Transmit: **ERA** [,a] <CR>[<LF>]

	Description
a	Switching behaviour error relay, a = 0 → Switches for all errors (default) 1 → Only unit errors 2 → Sensor error A1 and unit error 3 → Sensor error A2 and unit error 4 → Sensor error B1 and unit error 5 → Sensor error B2 and unit error

Receive: <ACK><CR><LF>

Transmit: <ENQ>

Receive: a <CR><LF>

	Description
a	Switching behaviour error relay

6.8.7 EVA - Measurement Range End Value

Transmit: **EVA** [,a] <CR>[<LF>]

	Description
a	Measurement range end value, a = 0 → UR or OR is displayed when an underrange or overrange occurs (default) 1 → The measurement range end value is displayed when an underrange or overrange occurs

Receive: <ACK><CR><LF>

Transmit: <ENQ>

Receive: a <CR><LF>

	Description
a	Measurement range end value

6.8.8 LNG - Language (Display)

Transmit: **LNG** [,a] <CR>[<LF>]

	Description
a	Language, a = 0 → English (default) 1 → German 2 → French

Receive: <ACK><CR><LF>

Transmit: <ENQ>

Receive: a <CR><LF>

	Description
a	Language

6.8.9 PUC - Penning Underrange Control

Transmit: **PUC** [,a] <CR>[<LF>]

	Description
a	Underrange control, a = 0 -> Off (default) 1 -> On

Receive: <ACK><CR><LF>

Transmit: <ENQ>

Receive: a <CR><LF>

	Description
a	Underrange control

6.8.10 SAV - Save Parameters (EEPROM)



Caution



Interruption of the current connection

Resetting the parameters to factory settings also resets communication parameters (e.g. transmission rate, Ethernet settings) and can lead to an interruption of the current connection.

Reset parameter to factory setting only if it is guaranteed that no malfunction is triggered by an interruption of the current connection.

Transmit: **SAV** [,a] <CR>[<LF>]

	Description
a	Save parameters to EEPROM, a = 0 -> Save default parameters (default) 1 -> Save user parameters (user) 2 -> Save user parameters with hotstart (user hotstart)

Receive: <ACK><CR><LF>

Command "SAV,0"

Resets all parameters to factory settings.

Command "SAV,1"

Stores parameter values that have been changed via the serial interface. Parameters that have been changed via the buttons on the controller are automatically saved.

Command "SAV,2"

Saves as "SAV,1" and additionally activates the hotstart. Thus, a measuring circuit will be switched on automatically after a power failure. The measuring circuit must be switched on at the time of saving.

6.8.11 UNI - Pressure Unit

Transmit: **UNI** [,a] <CR><LF>

	Description
a	Pressure unit, a = 0 → mbar (default) 1 → Torr 2 → Pascal 3 → Micron 4 → hPascal 5 → Volt 6 → Ampere

Receive: <ACK><CR><LF>

Transmit: <ENQ>

Receive: a <CR><LF>

	Description
a	Pressure unit

6.9 Communication Parameters

6.9.1 BAU - Transmission rate USB

When switching over, the response is already transmitted with the changed transmission rate.

Transmit: **BAU** [,a] <CR>[<LF>]

	Description
a	Transmission rate, a = 0 -> 9600 Baud 1 -> 19200 Baud 2 -> 38400 Baud 3 -> 57600 Baud 4 -> 115200 Baud (default)

Receive: <ACK><CR><LF>

Transmit: <ENQ>

Receive: x <CR><LF>

	Description
a	Transmission rate

6.9.2 BAR - Transmission rate RS485

When switching over, the response is already transmitted with the changed transmission rate.

Transmit: **BAR** [,a] <CR>[<LF>]

	Description
a	Transmission rate, a = 0 -> 9600 Baud 1 -> 19200 Baud 2 -> 38400 Baud 3 -> 57600 Baud 4 -> 115200 Baud (default)

Receive: <ACK><CR><LF>

Transmit: <ENQ>

Receive: a <CR><LF>

	Description
a	Transmission rate

6.9.3 BAI - Transmission rate IFxxx

If the VGC094 is operated with the Profibus interface board IF300P, the transmission rate must be set to 19200 baud.

Transmit: **BAI** [,a] <CR><LF>

	Description
a	Transmission rate IFxxx, a = 0 → 1200 Baud 1 → 2400 Baud 2 → 4800 Baud 3 → 9600 Baud (default) 4 → 19200 Baud

Receive: <ACK><CR><LF>

Transmit: <ENQ>

Receive: a <CR><LF>

	Description
a	Transmission rate

6.9.4 ETH - Ethernet Configuration

With dynamic DHCP configuration, the parameters b, c and d are automatically determined and do not have to be specified.

Transmit: **ETH** [,a,bbb.bbb.bbb.bbb,ccc.ccc.ccc.ccc,ddd.ddd.ddd.ddd] <CR><LF>

Receive: <ACK><CR><LF>

Transmit: <ENQ>

Receive: a,bbb.bbb.bbb.bbb,ccc.ccc.ccc.ccc,ddd.ddd.ddd.ddd <CR><LF>

	Description
a	DHCP (dynamic host configuration protocol), a = 0 → Static (default) 1 → Dynamic
bbb.bbb.bbb.bbb	IP address
ccc.ccc.ccc.ccc	Subnet address
ddd.ddd.ddd.ddd	Gateway address

Receive: <ACK><CR><LF>

Receive: <ENQ>

Receive: a,bbb.bbb.bbb.bbb,ccc.ccc.ccc.ccc,ddd.ddd.ddd.ddd <CR><LF>

	Description
a	DHCP
bbb.bbb.bbb.bbb	IP address
ccc.ccc.ccc.ccc	Subnet address
ddd.ddd.ddd.ddd	Gateway address

6.9.5 NAD - Node Address (unit address) for RS485

Transmit: **NAD** [,a] <CR>[<LF>]

	Description
a	Unit address, a = 1 ... 24 (1 = default)

Receive: <ACK><CR><LF>

Transmit: <ENQ>

Receive: a <CR><LF>

	Description
a	Unit address

The node address is used to address the devices if several devices are connected via a bus. Only the device that was addressed once with <ESC> a responds. If another device is to respond, it must be addressed. The remaining devices release the bus.

Transmit: <ESC>a

6.10 Data Logger Parameters



The group is only available when a USB memory stick formatted for the the FAT file system (FAT32) is plugged in. Use memory sticks with max. 32 GB.

6.10.1 DAT - Date

Transmit: **DAT** [,yyyy-mm-dd] <CR>[<LF>]
 Receive: <ACK><CR><LF>
 Transmit: <ENQ>
 Receive: yyyy-mm-dd <CR><LF>

	Description
yyyy-mm-dd	Current date in the format yyyy-mm-dd

6.10.2 LCM - Start / Stop Data Logger



Further processing of recorded data (e.g. with Excel), pay attention to the corresponding country-specific decimal separator (comma or dot).

Transmit: **LCM** [,a,b,c,ddddddd,e] <CR>[<LF>]
 Receive: <ACK><CR><LF>
 Transmit: <ENQ>
 Receive: a,b,c,ddddddd,e <CR><LF>

	Description
a	Data logger command, a = 0 → Stop / recording stopped 1 → Start / recording running 2 → Clear / deletion of measurement data file from USB memory stick
b	Data logging interval, b = 0 → Recording interval 1 s 1 → Recording interval 10 s 2 → Recording interval 30 s 3 → Recording interval 60 s 4 → With measurement value change ≥1% 5 → With measurement value change ≥5%
c	Decimal separator, c = 0 → , (decimal comma) (default) 1 → . (decimal point)
ddddddd	File name (max. 8 characters)
e	Recording mode, e = 0 → Manual (default) 1 → Automatic

6.10.3 TIM - Time

Transmit: **TIM** [,hh:mm] <CR>[<LF>]
 Receive: <ACK><CR><LF>
 Transmit: <ENQ>
 Receive: hh:mm <CR><LF>

	Description
hh:mm	Current time in the format hh:mm [24 hours]

6.11 Group Setup



The group is only available when a USB memory stick formatted for the FAT file system (FAT32) is plugged in. Use memory sticks with max. 32 GB.

6.11.1 SCM - Store / Load Parameters (USB)

Transmit: **SCM** [,a,b] <CR>[<LF>]

Receive: <ACK><CR><LF>

Transmit: <ENQ>

Receive: a <CR><LF>

	Description
a	Setup parameters, a = 0 → Storage completed (read only) 1 → Loading all parameters from the VGC094 the to the USB memory stick 2 → Loading all parameters from the USB memory stick to the VGC094 3 → Formatting USB memory stick (FAT32) 4 → Deleting parameter files (extension .CSV) from the USB memory stick
b	Number in file name (0 ... 99)

6.12 Test Parameters

(For service personnel)

6.12.1 ADC - A/D Converter Test

Transmit: **ADC** <CR>[<LF>]

Receive: <ACK><CR><LF>

Transmit: <ENQ>

Receive: aa.aa,bb.bb,cc.cc,dd.dd <CR><LF>

	Description
aa.aa	A/D converter channel A1 Measurement signal [0.00 ... 11.00 V]
bb.bb	A/D converter channel A2 Measurement signal [0.00 ... 11.00 V]
cc.cc	A/D converter channel B1 Measurement signal [0.00 ... 11.00 V]
dd.dd	A/D converter channel B2 Measurement signal [0.00 ... 11.00 V]

6.12.2 CDA - Re-calibration

Transmit: **CDA** [,yyyy-mm-dd] <CR>[<LF>]

Receive: <ACK><CR><LF>

Transmit: <ENQ>

Receive: yyyy-mm-dd <CR><LF>

	Description
yyyy-mm-dd	Date of next re-calibration. If the date was reached, a warning is displayed.

6.12.3 DIS - Display Test

Transmit: **DIS** [,a] <CR>[<LF>]

	Description
a	Display test, a = 0 → Stops test - display matches operating mode (default) 1 → Starts test - all LEDs on

Receive: <ACK><CR><LF>

Transmit: <ENQ>

Receive: x <CR><LF>

	Description
a	Display test status

6.12.4 EEP - EEPROM Test

Test of the parameter memory.

Transmit: **EEP** <CR>[<LF>]

Receive: <ACK><CR><LF>

Transmit: <ENQ> Starts the test (duration <1 s)



Do not repeat the test continuously (EEPROM life).

Receive: aaaa <CR><LF>

	Description
aaaa	Error word

6.12.5 EPR - FLASH Test

Test of the program memory.

Transmit: **EPR** <CR>[<LF>]

Receive: <ACK><CR><LF>

Transmit: <ENQ> Starts the test (very brief)

Receive: aaaa <CR><LF>

	Description
aaaa	Error word

6.12.6 HDW - Hardware Version

Transmit: **HDW** <CR>[<LF>]



Receive: <ACK><CR><LF>

Transmit: <ENQ>

Receive: a.aa <CR><LF>

	Description
a.aa	Hardware version, e.g. 1.00

6.12.7 IOT - I/O Test

 Caution
 <p>The relays switch irrespective of the pressure. Starting a test program may cause unwanted effects in connected control systems. Disconnect all sensor cables and control system lines to ensure that no control commands or messages are triggered by mistake.</p>

Transmit: **IOT** [,a,bb] <CR>[<LF>]

	Description
a	Test status, a = 0 -> Test stopped 1 -> Test running
bb	Relay status (in hex format), bb = 00 -> All relays deactivated 01 -> Switching function relay 1 activated 02 -> Switching function relay 2 activated 04 -> Switching function relay 3 activated 08 -> Switching function relay 4 activated 10 -> Error relay activated 1F -> All relays activated

Receive: <ACK><CR><LF>

Transmit: <ENQ>

Receive: a,bb <CR><LF>

	Description
a	I/O test status
bb	Relay status

Example: 14 = Switching function relay 3 and error relay activated

6.12.8 LOC - Keylock

Transmit: **LOC** [,a] <CR>[<LF>]

	Description
a	Keylock, a = 0 -> Off (default) 1 -> On 2 -> On ¹⁾ (only via interface)

¹⁾ If the input lock was activated via the interface with a=2, it can only be deactivated again via the interface.

Receive: <ACK><CR><LF>

Transmit: <ENQ>

Receive: a <CR><LF>

	Description
a	Keylock status

6.12.9 **MAC** - Ethernet MAC Address

Transmit: **MAC** <CR>[<LF>]
 Receive: <ACK><CR><LF>
 Transmit: <ENQ>
 Receive: aa-aa-aa-aa-aa-aa <CR><LF>

	Description
aa-aa-aa-aa-aa-aa	Ethernet MAC address of the VGC094: 00-A0-41-xx-xx-xx

6.12.10 **PNR** - Firmware Version

Transmit: **PNR** <CR>[<LF>]
 Receive: <ACK><CR><LF>
 Transmit: <ENQ>
 Receive: a.aa <CR><LF>

	Description
a.aa	Firmware version, e.g. 1.00

6.12.11 **RHR** - Operating Hours

Transmit: **RHR** <CR>[<LF>]
 Receive: <ACK><CR><LF>
 Transmit: <ENQ>
 Receive: a <CR><LF>

	Description
a	Run (operating) hours, e.g. 24 [hours]

6.12.12 **TKB** - Operator Keys Test

Transmit: **TKB** <CR>[<LF>]
 Receive: <ACK><CR><LF>
 Transmit: <ENQ>
 Receive: abcd <CR><LF>

	Description
a	Key 1, a = 0 → Not pushed 1 → Pushed
b	Key 2, b = 0 → Not pushed 1 → Pushed
c	Key 3, c = 0 → Not pushed 1 → Pushed
d	Key 4, d = 0 → Not pushed 1 → Pushed

6.12.13 TLC - Torr Lock

Transmit: **TLC** [,a] <CR>[<LF>]

	Description
a	Torr lock, a = 0 -> Off (default) 1 -> On

Receive: <ACK><CR><LF>

Transmit: <ENQ>

Receive: a <CR><LF>

	Description
a	Torr lock status

6.12.14 WDT - Watchdog Control

Transmit: **WDT** [,a] <CR>[<LF>]

	Description
a	Watchdog control, a = 0 -> Manual error acknowledgement 1 -> Automatic error acknowledgement ¹⁾ (default)



¹⁾ If the watchdog has responded, the error is automatically acknowledged and cleared after 2 s.

Receive: <ACK><CR><LF>

Transmit: <ENQ>

Receive: a <CR><LF>

	Description
a	Watchdog control

6.13 Further Parameters

6.13.1 AYT - Are you There?

Transmit: **AYT** <CR>[<LF>]

Receive: <ACK><CR><LF>

Transmit: <ENQ>

Receive: a,b,c,d,e <CR><LF>

	Description
a	Type of the unit, e.g. VGC094
b	Model No. of the unit, e.g. 398-401
c	Serial No. of the unit, e.g. 100
d	Firmware version of the unit, e.g. 1.00
e	Hardware version of the unit, e.g. 1.00

6.13.2 SME - Show Me

Transmit: **SME** <CR>[<LF>]
 Receive: <ACK><CR><LF>
 Transmit: <ENQ>
 Receive: a <CR><LF>

	Description
a	0 -> Visualization off 1 -> Visualization on: The backlight of the addressed controller flashes for 5 seconds.

6.13.3 TMP - Inner Temperature of the Unit

Inner temperature of the VGC094.

Transmit: **TMP** <CR>[<LF>]
 Receive: <ACK><CR><LF>
 Transmit: <ENQ>
 Receive: aa <CR><LF>

	Description
aa	Temperature (± 2 °C) [°C]

6.13.4 VBT - Battery Voltage

Transmit: **VBT** <CR>[<LF>]
 Receive: <ACK><CR><LF>
 Transmit: <ENQ>
 Receive: aaaa <CR><LF>

	Description
aaaa	Battery voltage [mV] Nominal value: 3 V

6.14 Example



"Transmit (T)" and "Receive (R)" are related to Host.

T: TID <CR> [<LF>]	Request for gauge identification
R: <ACK> <CR> <LF>	Positive acknowledgement
T: <ENQ>	Request for data transmission
R: PI300D,CP300Cx9,IF300x <CR> <LF>	Gauge identifications
T: SEN <CR> [<LF>]	Request for gauge statuses
R: <ACK> <CR> <LF>	Positive acknowledgement
T: <ENQ>	Request for data transmission
R: 0,0,0,0 <CR> <LF>	Gauge statuses
T: SP1 <CR> [<LF>]	Request for parameters of switching function 1 (setpoint 1)
R: <ACK> <CR> <LF>	Positive acknowledgement
T: <ENQ>	Request for data transmission
R: 1.0E-09,9.0E-07,2 <CR> <LF>	Thresholds
T: SP1 ,6.8E-3,9.8E-3,2 <CR> [<LF>]	Modification of parameters of switching function 1 (setpoint 1)
R: <ACK> <CR> <LF>	Positive acknowledgement
T: FOL , 1,2,2,2 <CR> [<LF>]	Modification of filter time constant (syntax error)
R: <NAK> <CR> <LF>	Negative acknowledgement
T: <ENQ>	Request for data transmission
R: 0001 <CR> <LF>	ERROR word
T: FIL , 1,2,2,2 <CR> [<LF>]	Modification of filter time constant
R: <ACK> <CR> <LF>	Positive acknowledgement
T: <ENQ>	Request for data transmission
R: 1,2,2,2 <CR> <LF>	Filter time constants

7 Maintenance

Cleaning the VGC094

For cleaning the outside of the unit a slightly moist cloth will usually do. Do not use any aggressive or scouring cleaning agents.

STOP
DANGER



Mains voltage
Contact with live parts is extremely hazardous when liquids penetrate into the unit.

Make sure no liquids penetrate into the equipment.



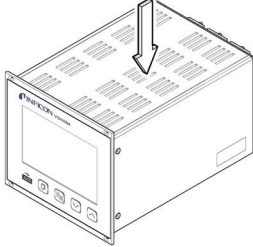

Battery replacement











The product contains a battery (type CR2032, service life >10 years) in order to maintain the data integrity of the real-time clock. Battery replacement is necessary if the real-time clock repeatedly shows an incorrect date. Please contact your local INFICON service center.

8 Troubleshooting

Signalization of errors

The error is shown in the dot matrix and the error relay opens (connection *CONTOL* →  17).

Error messages

	Possible cause and remedy/acknowledgement
SENSOR ERROR CH1	<p>Interruption or instability in sensor line or connector (Sensor error).</p> <p>⇒ Acknowledge with the  key.</p>
WATCHDOG ERROR	<p>Possible cause and remedy/acknowledgement</p> <p>The VGC094 has been turned on too fast after power off.</p> <p>⇒ Acknowledge with the  key. If the watchdog is set to Auto, the VGC094 acknowledges the message automatically after 2 s (→  50).</p> <p>The watchdog has tripped because of a severe electric disturbance or an operating system error.</p> <p>⇒ Acknowledge with the  key. If the watchdog is set to AUTO, the VGC094 acknowledges the message automatically after 2 s (→  50).</p>
UART ERROR	<p>Possible cause and remedy/acknowledgement</p> <p>Error in UART.</p> <p>⇒ Acknowledge with the  key.</p>
PROGRAM CORRUPT	<p>Possible cause and remedy/acknowledgement</p> <p>Program memory error (FLASH).</p> <p>⇒ Acknowledge with the  key.</p>
DATA CORRUPTED	<p>Possible cause and remedy/acknowledgement</p> <p>Parameter memory error (EEPROM).</p> <p>⇒ Acknowledge with the  key.</p>
DISPLAY ERROR	<p>Possible cause and remedy/acknowledgement</p> <p>Display driver error.</p> <p>⇒ Acknowledge with the  key.</p>
FATAL ERROR	<p>Possible cause and remedy/acknowledgement</p> <p>General, serious error</p> <p>⇒ Acknowledge with the  key.</p>

Technical support



If the problem persists after the message has been acknowledged several times and/or the gauge has been exchanged, please contact your nearest INFICON service center.

9 Repair

Return defective products to your nearest INFICON service center for repair. INFICON assumes no liability and the warranty is rendered null and void if repair work is carried out by the end-user or by third parties.

10 Accessories

Type	Description	Ordering No.
PI300D	Pirani measurement board	IG 546 920-T
PI300DN	Pirani measurement board	IG 549 214-T
PE300DC9	Pirani / cold cathode measurement board (Index B and higher)	IG 441 375-T
CP300C9	Pirani / cold cathode measurement board (Index B and higher)	IG 441 000-T
CP300C10	Pirani / cold cathode measurement board (Index B and higher)	IG 441 114-T
CP300T11	Pirani / cold cathode measurement board (Index B and higher)	IG 441 080-T
CP300T11L	Pirani / cold cathode measurement board (Index A and higher)	IG 441 120-T
IF300A	Interface and relay board (RS232C)	IG 441 130-T
IF300B	Interface and relay board (RS232C)	IG 441 250-T
IF300C	Interface and relay board (RS422)	IG 441 390-T
IF300P	Interface and relay board (Profibus)	IG 441 395-T
IF301P	Interface and relay board (Profibus)	IG 441 396-T
IF500PN	Interface board (Profinet)	398-421
	Mating connector, D-sub for IF300A	BG 441 128-T
	Mating connector, D-sub for IF300A / IF300C	BG 441 129-T
	Relay connector cpl. for IF300B	BG 546 999-T
	Interface cable 0.4 m for IF300B	BG 548 932-T
	Mating connector, D-sub for IF300C (RS422)	BG 441 145-T
	Blanking panel for measurement boards	BG 441 259
	Blanking panel for interface and relay boards	BG 441 017

11 Storage



Caution



Electronic components.

Inappropriate storage (static electricity, humidity etc.) may damage electronic components.

Store the product in an antistatic bag or container. Observe the relevant specifications under Technical Data (→ 10).

12 Disposal



WARNING



Substances detrimental to the environment.

Products or parts thereof (mechanical and electric components, operating fluids etc.) may be detrimental to the environment.

Please dispose of such materials in accordance with the relevant local regulations.

After disassembling the product, separate its components in electronic and non-electronic components and recycled.

Appendix

A: Conversion Tables

Weights

	kg	lb	slug	oz
kg	1	2.205	68.522×10^{-3}	35.274
lb	0.454	1	31.081×10^{-3}	16
slug	14.594	32.174	1	514.785
oz	28.349×10^{-3}	62.5×10^{-3}	1.943×10^{-3}	1

Pressures

	N/m ² , Pa	Bar	mBar, hPa	Torr	at
N/m ² , Pa	1	10×10^{-6}	10×10^{-3}	7.5×10^{-3}	9.869×10^{-6}
Bar	100×10^3	1	10^3	750.062	0.987
mBar, hPa	100	10^{-3}	1	750.062×10^{-3}	0.987×10^{-3}
Torr	133.322	1.333×10^{-3}	1.333	1	1.316×10^{-3}
at	101.325×10^3	1.013	1.013×10^3	760	1

Pressure units used in the vacuum technology

	mBar	Bar	Pa	hPa	kPa	Torr mm HG
mBar	1	1×10^{-3}	100	1	0.1	0.75
Bar	1×10^3	1	1×10^5	1×10^3	100	750
Pa	0.01	1×10^{-5}	1	0.01	1×10^{-3}	7.5×10^{-3}
hPa	1	1×10^{-3}	100	1	0.1	0.75
kPa	10	0.01	1×10^3	10	1	7.5
Torr mm HG	1.332	1.332×10^{-3}	133.32	1.3332	0.1332	1

$$1 \text{ Pa} = 1 \text{ N/m}^2$$

Linear measurements

	mm	m	inch	ft
mm	1	10^{-3}	39.37×10^{-3}	3.281×10^{-3}
m	10^3	1	39.37	3.281
inch	25.4	25.4×10^{-3}	1	8.333×10^{-2}
ft	304.8	0.305	12	1

Temperature

	Kelvin	Celsius	Fahrenheit
Kelvin	1	$^{\circ}\text{C} + 273.15$	$(^{\circ}\text{F} + 459.67) \times 5/9$
Celsius	$\text{K} - 273.15$	1	$5/9 \times ^{\circ}\text{F} - 17.778$
Fahrenheit	$9/5 \times \text{K} - 459.67$	$9/5 \times (^{\circ}\text{C} + 17.778)$	1

B: Measurement Signal vs. Pressure

Pirani gauges, 0 ... 10 V	→ 90
Pirani gauges, 4 ... 20 mA	→ 91
Measurement plug-in board CP300C9, 0 ... 10 V	→ 92
Measurement plug-in board CP300C9, 4 ... 20 mA	→ 93
Measurement plug-in board CP300C10, 0 ... 10 V	→ 94
Measurement plug-in board CP300C10, 4 ... 20 mA	→ 95
Measurement plug-in board CP300T11/T11L, 0 ... 10 V	→ 96
Measurement plug-in board CP300T11/T11L, 4 ... 20 mA	→ 97

B 1: Pirani Gauges, 0 ... 10 V

Conversion formulae

$$p = c \times 10^{(0.7 \times U)}$$

$$U = 10/7 \times (\log p - \log c)$$

valid in range:

$1 \times 10^{-4} \text{ mbar} < p < 1000 \text{ mbar}$
 $7.5 \times 10^{-5} \text{ Torr} < p < 750 \text{ Torr}$
 $1 \times 10^{-2} \text{ Pa} < p < 1 \times 10^5 \text{ Pa}$

where	Measuring signal (output voltage) U	Pressure p	Constant (depending on pressure unit) c
	[V]	[mbar]	1×10^{-4}
	[V]	[Pa]	0.01
	[V]	[kPa]	1×10^5
	[V]	[Torr]	7.5×10^{-5}
	[V]	[mTorr]	0.075

Conversion curve

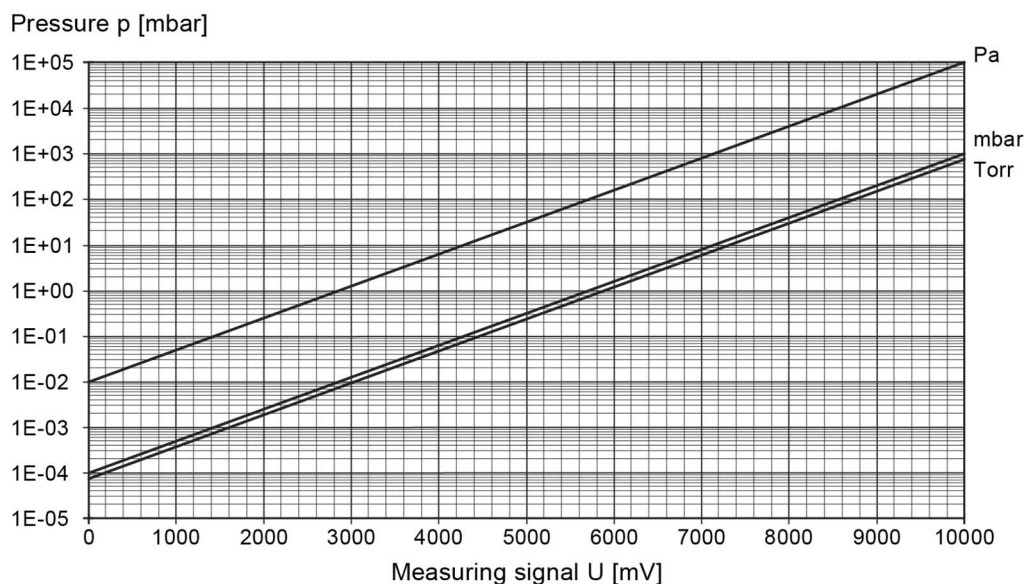

B 2: Pirani Gauges, 4 ... 20 mA

Conversion formulae

$$p = d \times 10^{(7/16 \times I)}$$

valid in range:

$$1 \times 10^{-4} \text{ mbar} < p < 1000 \text{ mbar}$$

$$7.5 \times 10^{-5} \text{ Torr} < p < 750 \text{ Torr}$$

$$1 \times 10^{-2} \text{ Pa} < p < 1 \times 10^5 \text{ Pa}$$

$$I = 16/7 \times (\log p - \log d)$$

where	Measuring signal (output current) I	Pressure p	Constant (depending on pressure unit) d
	[mA]	[mbar]	1.778×10^{-6}
	[mA]	[Pa]	1.778×10^{-4}
	[mA]	[kPa]	1.778×10^{-7}
	[mA]	[Torr]	1.334×10^{-6}
	[mA]	[mTorr]	1.334×10^{-3}

Conversion curve

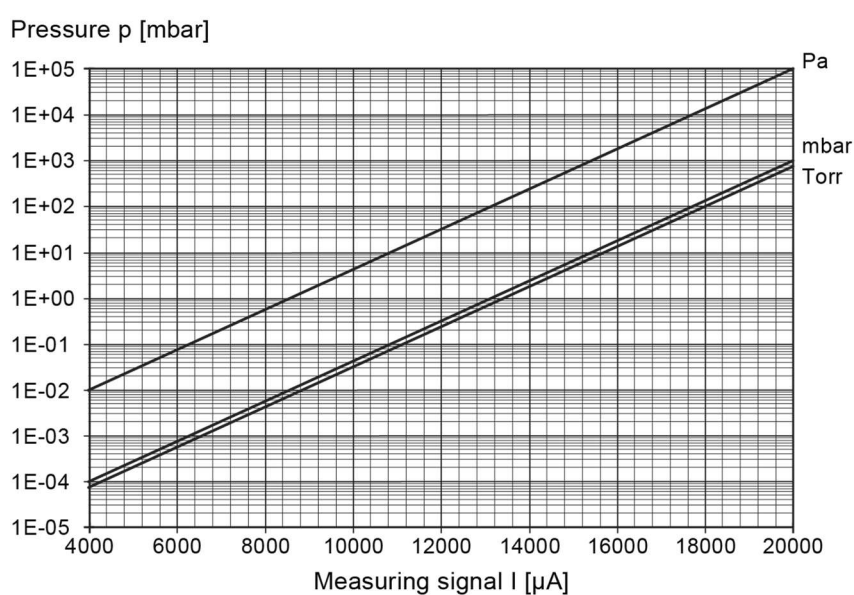

B 3: Measurement Plug-In Board CP300C9, 0 ... 10 V

Conversion formulae

$$p = c \times 10^{(0.7 \times U)}$$

$$U = 10/7 \times (\log p - \log c)$$

valid in range:

$1 \times 10^{-9} \text{ mbar} < p < 1 \times 10^{-2} \text{ mbar}$
 $7.5 \times 10^{-10} \text{ Torr} < p < 7.5 \times 10^{-3} \text{ Torr}$
 $1 \times 10^{-7} \text{ Pa} < p < 1 \text{ Pa}$

where	Measuring signal (output voltage) U	Pressure p	Constant (depending on pressure unit) c
	[V]	[mbar]	1×10^{-9}
	[V]	[Pa]	1×10^{-7}
	[V]	[kPa]	1×10^{-10}
	[V]	[Torr]	7.5×10^{-10}
	[V]	[mTorr]	7.5×10^{-7}

Conversion curve

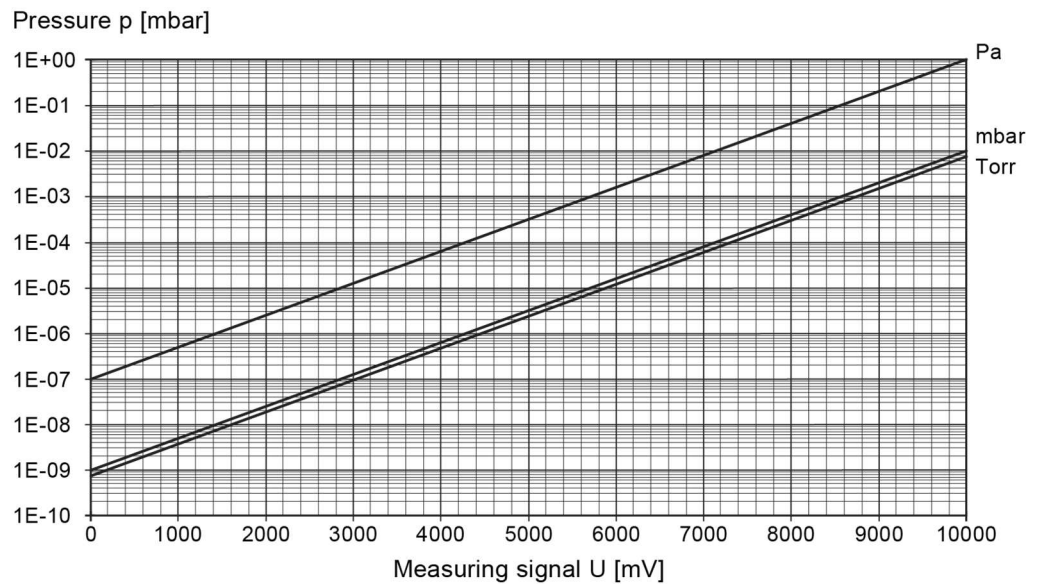

B 4: Measurement Plug-In Board CP300C9, 4 ... 20 mA

Conversion formulae

$$p = d \times 10^{(7/16 \times I)}$$

$$I = 16/7 \times (\log p - \log d)$$

valid in range:

$1 \times 10^{-9} \text{ mbar} < p < 1 \times 10^{-2} \text{ mbar}$
 $7.5 \times 10^{-10} \text{ Torr} < p < 7.5 \times 10^{-3} \text{ Torr}$
 $1 \times 10^{-7} \text{ Pa} < p < 1 \text{ Pa}$

where	Measuring signal (output current) I	Pressure p	Constant (depending on pressure unit)-d
	[mA]	[mbar]	1.778×10^{-11}
	[mA]	[Pa]	1.778×10^{-9}
	[mA]	[kPa]	1.778×10^{-12}
	[mA]	[Torr]	1.334×10^{-11}
	[mA]	[mTorr]	1.334×10^{-8}

Conversion curve

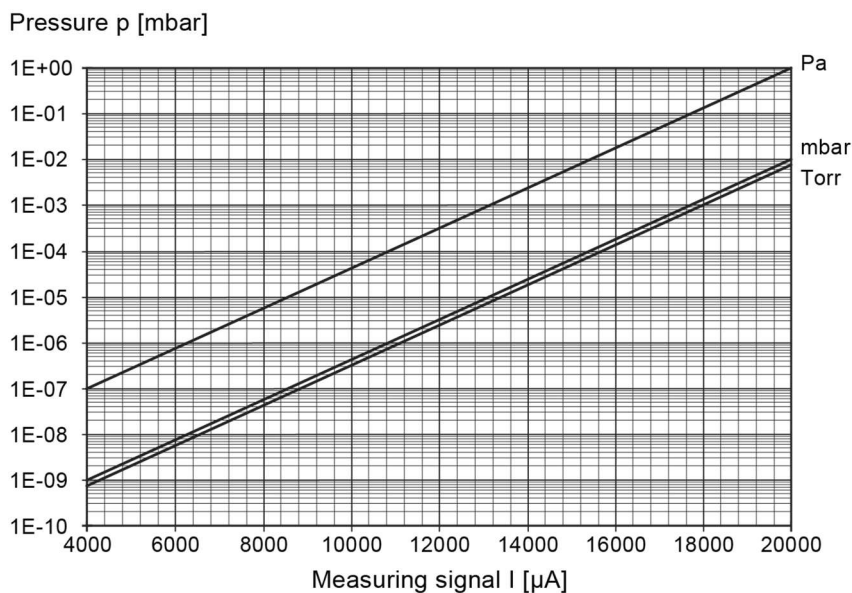

B 5: Measurement Plug-In Board CP300C10, 0 ... 10 V

Conversion formulae

$$p = c \times 10^{(0.8 \times U)}$$

$$U = 1.25 \times (\log p - \log c)$$

valid in range:

$$1 \times 10^{-10} \text{ mbar} < p < 1 \times 10^{-2} \text{ mbar}$$

$$7.5 \times 10^{-11} \text{ Torr} < p < 7.5 \times 10^{-3} \text{ Torr}$$

$$1 \times 10^{-8} \text{ Pa} < p < 1 \text{ Pa}$$

where	Measuring signal (output voltage) U	Pressure p	Constant (depending in pressure unit) c
	[V]	[mbar]	1×10^{-12}
	[V]	[Pa]	1×10^{-10}
	[V]	[kPa]	1×10^{-13}
	[V]	[Torr]	7.5×10^{-13}
	[V]	[mTorr]	7.5×10^{-10}

Conversion curve

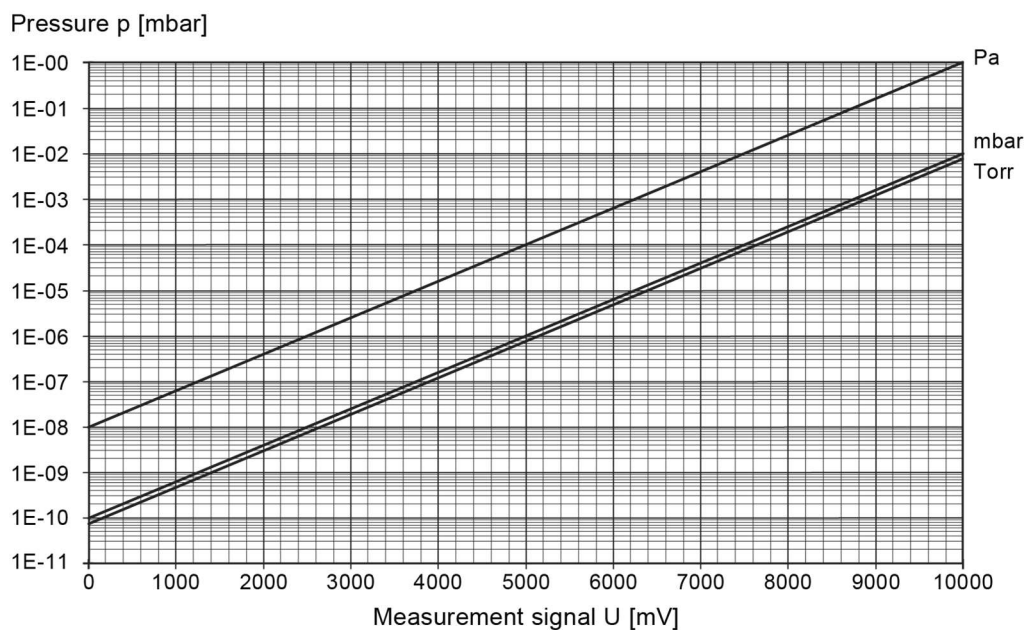

B 6: Measurement Plug-In Board CP300C10, 4 ... 20 mA

Conversion formulae

$$p = d \times 10^{(0.5 \times I)}$$

$$I = 2 \times (\log p - \log d)$$

valid in range:

$1 \times 10^{-10} \text{ mbar} < p < 1 \times 10^{-2} \text{ mbar}$
 $7.5 \times 10^{-11} \text{ Torr} < p < 7.5 \times 10^{-3} \text{ Torr}$
 $1 \times 10^{-8} \text{ Pa} < p < 1 \text{ Pa}$

where	Measuring signal (output current) I	Pressure p	Constant (depending on pressure unit) d
	[mA]	[mbar]	1×10^{-12}
	[mA]	[Pa]	1×10^{-10}
	[mA]	[kPa]	1×10^{-13}
	[mA]	[Torr]	7.5×10^{-13}
	[mA]	[mTorr]	7.5×10^{-10}

Conversion curve

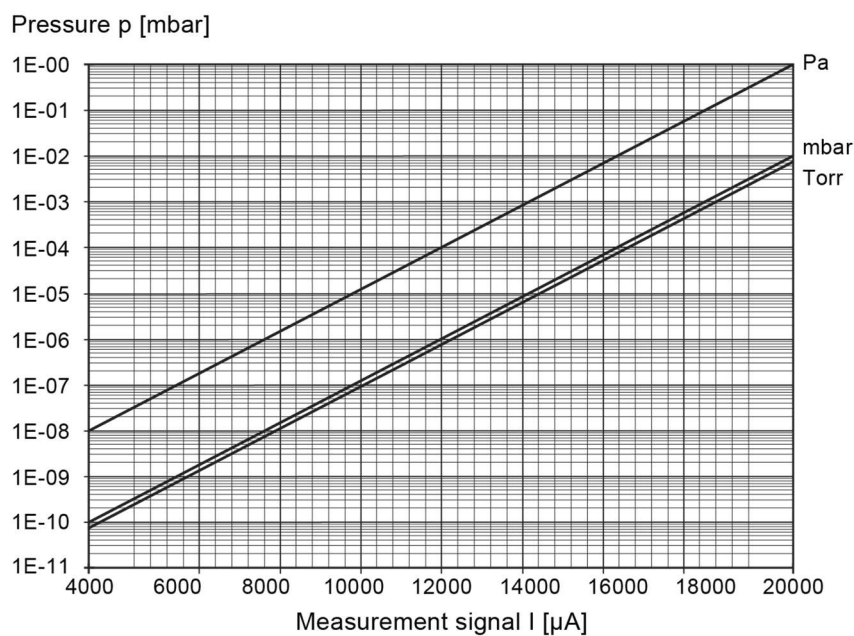

B 7: Measurement Plug-In Board CP300T11/T11L, 0 ... 10 V

Conversion formulae

$$p = c \times 10^{(0.9 \times U)}$$

$$U = 10/9 \times (\log p - \log c)$$

valid in range:

$1 \times 10^{-11} \text{ mbar} < p < 1 \times 10^{-2} \text{ mbar}$
 $7.5 \times 10^{-12} \text{ Torr} < p < 7.5 \times 10^{-3} \text{ Torr}$
 $1 \times 10^{-9} \text{ Pa} < p < 1 \text{ Pa}$

where	Measuring signal (output signal) U	Pressure p	Constant (depending on pressure unit) c
	[V]	[mbar]	1×10^{-11}
	[V]	[Pa]	1×10^{-9}
	[V]	[kPa]	1×10^{-12}
	[V]	[Torr]	7.5×10^{-12}
	[V]	[mTorr]	7.5×10^{-9}

Conversion curve

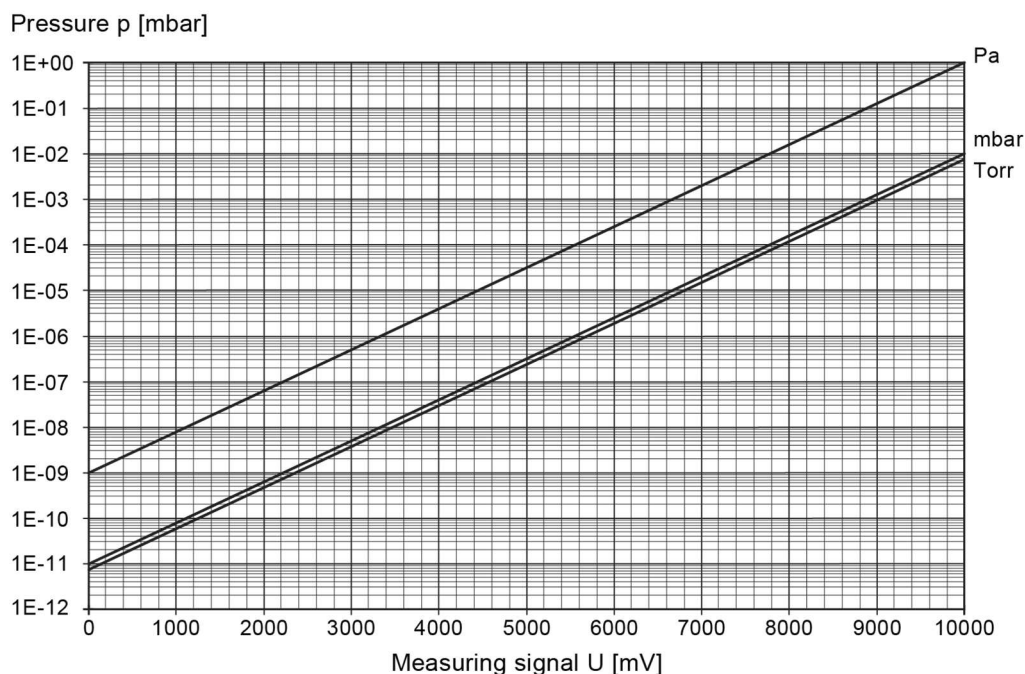

B 8: Measurement Plug-In Board CP300T11/T11L, 4 ... 20 mA

Conversion formulae

$$p = d \times 10^{(9/16 \times I)}$$

$$I = 16/9 \times (\log p - \log d)$$

valid in range:

$1 \times 10^{-11} \text{ mbar} < p < 1 \times 10^{-2} \text{ mbar}$
 $7.5 \times 10^{-12} \text{ Torr} < p < 7.5 \times 10^{-3} \text{ Torr}$
 $1 \times 10^{-9} \text{ Pa} < p < 1 \text{ Pa}$

where	Measuring signal (output current) I	Pressure p	Constant (depending on pressure) d
	[mA]	[mbar]	5.620×10^{-14}
	[mA]	[Pa]	5.620×10^{-12}
	[mA]	[kPa]	5.620×10^{-15}
	[mA]	[Torr]	4.215×10^{-14}
	[mA]	[mTorr]	4.215×10^{-11}

Conversion curve

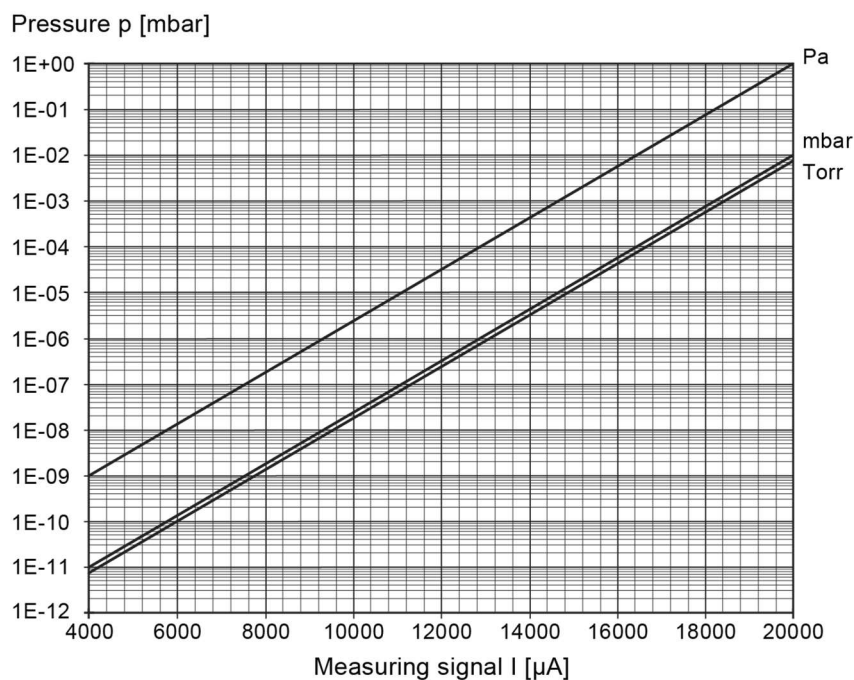

C: Firmware Update



If your VGC094 firmware needs updating, e.g. for implementing a new gauge type, please contact your nearest INFICON service center.

A firmware update is possible

- via a USB memory stick (type A connector on the front of the unit), or
- with the USB Update Tool via the USB type B connector on the rear of the unit.

User Parameters

Most of the settings you may have made in the Parameter mode will not be affected by a firmware update. However, we recommend that you save the parameters before an update (→ 47).

Firmware update with a USB memory stick (type A)



Not all USB memory sticks are automatically recognized by the VGC094, as they (particularly cheaper brands) do not always conform to USB standard specifications. Try a different memory stick before contacting your nearest INFICON service center.

- 1 Download two files with the ending ".S19" and ".CNF" from our website "www.inficon.com" to a USB memory stick.
- 2 Switch off the unit.
- 3 Plug in the memory stick and then turn on the unit.
- 4 The update occurs automatically in the following steps:

<code>BOOTING</code>	Very brief.
<code>BOOTLOADER Vx.x%</code>	Very brief.
<code>ERASING FW...</code>	Old firmware is being deleted from the unit.
<code>UPDATING FW...</code>	New firmware is being loaded onto the unit.
<code>UPDATE COMPLETE</code>	Update completed.

- 5 Remove the memory stick and the unit will restart automatically.
- 6 If necessary, customer-specific settings saved before the update may now be resaved to the unit (→ 47).

Firmware update with USB Update Tool (USB type B)

Precondition: Windows XP, 7, 8 or 10 operating system



During firmware update, no USB memory stick should be connected on the front of the unit.



If a virtual serial interface (COM) is not automatically established, you may download and then install the driver from the website "<https://ftdichip.com/drivers/vcp-drivers/>".

- 1 Download the USB UpdateTool from our website "www.inficon.com" or copy it from the enclosed CD ROM.
- 2 Connect the unit to the PC using a type A/B USB cable.

- Start USB UpdateTool, select the COM interface from the menu and click on <Connect>.

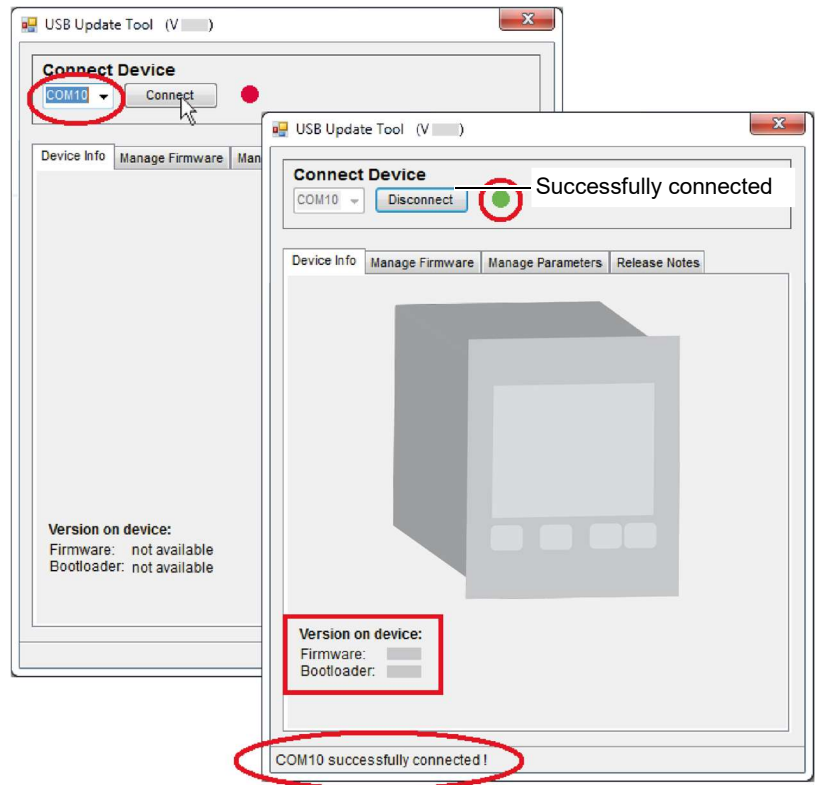

- Click on <Release Notes> tab page to view the software release notes.

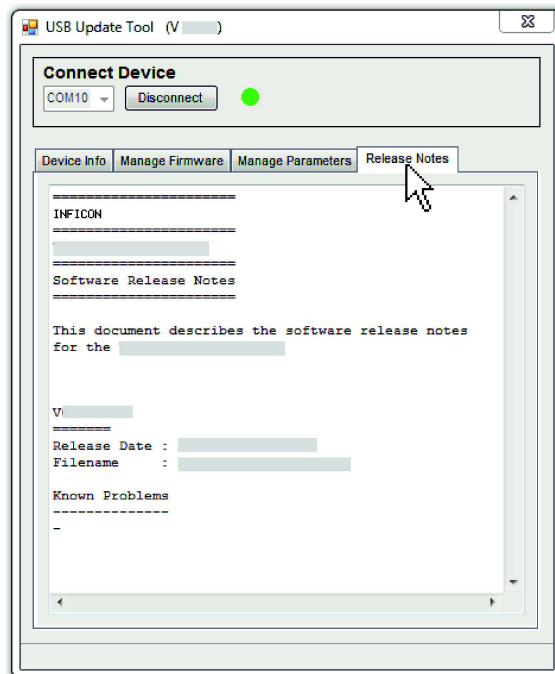

- 5** We recommend that you download the parameters on the <Manage Parameters> tab page before an update.

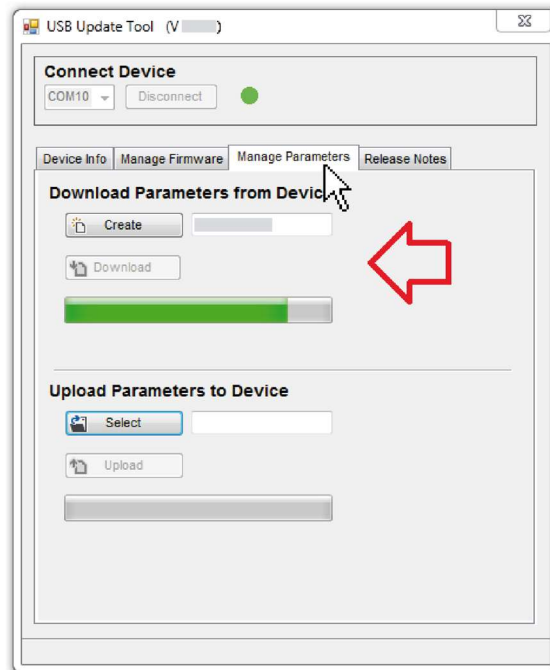

- 6** Click the <Manage Firmware> tab page, select firmware ...

- Option <Load from disk>: Download a copy of the firmware from our website "www.inficon.com". Then, select the appropriate folder in the update tool.
- Option <Load from server>: The update tool connects to the update server. Select the desired firmware version from the selection list.

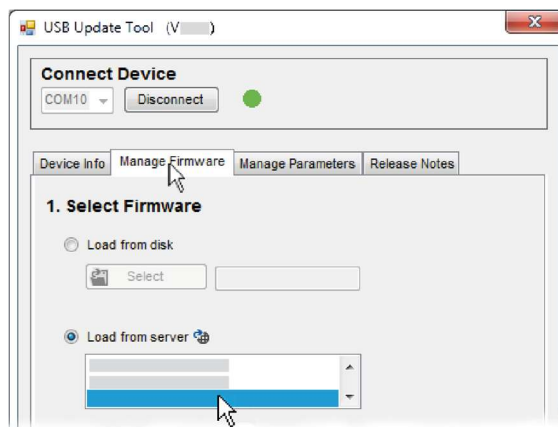

... and click <Update>: The firmware is updated.

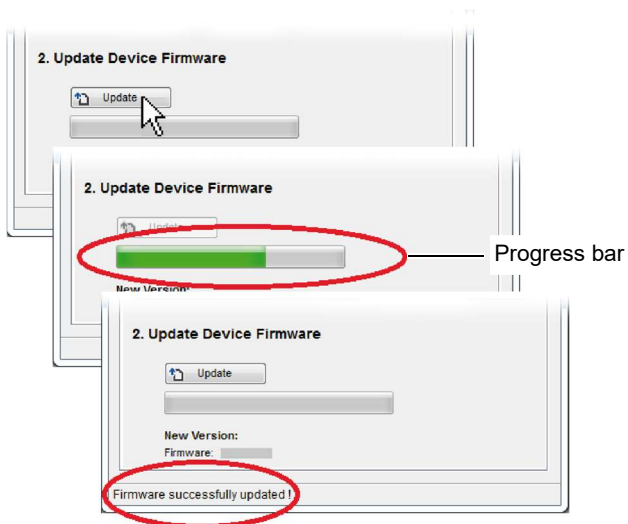

If the update was not successful, try again.



7 Upload parameters back to device.

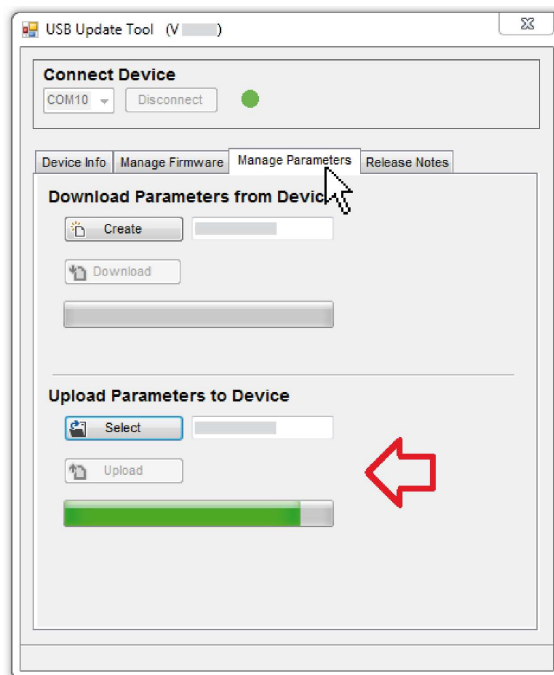

D: Ethernet Configuration

The VGC094 can be connected via the virtual COM interface or via Winsock / Telnet.

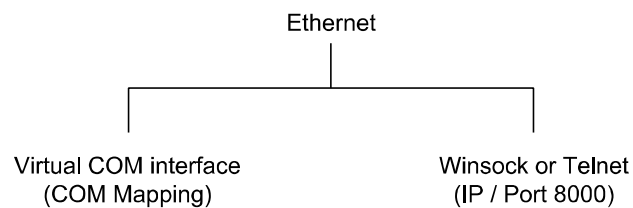

Virtual COM interface (COM Mapping)

The user program (e.g. terminal program, LabView, etc.) must support serial interfaces. Under Microsoft Windows operating systems the VGC094 is listed as a virtual COM interface.

The virtual COM interfaces allow you to access each program that supports serial interfaces (e.g. terminal program, LabView, etc.).



Please contact your network administrator, before starting Ethernet configuration.



Your operating system should be updated first. Additionally, administrator rights are required.

D 1: Connect the VGC094 to a Network

With registration

- 1** Readout the MAC address of the VGC094 (→ [49](#)).
- 2** The VGC094 should be registered in the network by the network administrator. After registration ask him for the Ethernet parameters (IP ADDRESS, GATEWAY, NETMASK and DHCP).
- 3** Configuring the VGC094:
 - Save all VGC094 parameters on a USB memory stick ("SAVE SETUP", → [47](#)).
 - Set the Ethernet parameters (IP ADDRESS, GATEWAY, NETMASK and DHCP) in the saved CSV file on the memory stick.
 - Load the modified parameters onto the VGC094 ("RESTORE SETUP", → [47](#)).
 - Connect the VGC094 with an Ethernet patch cable to the network.
- 4** Search for the VGC094 in the network using the Ethernet Configuration Tool and assign it to a virtual COM interface (→ [102](#)).
- 5** Start the program for communication with the VGC094 and connect it to the assigned COM interface.

Without registration

- 1 If unknown, ask the network administrator for the Ethernet parameters (IP ADDRESS, GATEWAY, NETMASK and DHCP).
- 2 Configuring the VGC094:
 - Save all VGC094 parameters on a USB memory stick ("SAVE SETUP", → 47).
 - Set the Ethernet parameters (IP ADDRESS, GATEWAY, NETMASK and DHCP) in the saved CSV file on the memory stick.
 - Load the modified parameters onto the VGC094 ("RESTORE SETUP", → 47).
 - Connect the VGC094 with an Ethernet patch cable to the network.
- 3 Search for the VGC094 in the network using the Ethernet Configuration Tool and assign it to a virtual COM interface (→ 102).
- 4 Start the program for communication with the VGC094 and connect it to the assigned COM interface.

D 2: Connect the VGC094 to a Computer

Computer with DHCP server

- 1 Connect the VGC094 to a computer ...
 - with a crossover Ethernet cable,
 - via a switch, or
 - with an Ethernet patch cable (precondition: the interface is auto MDI-X capable).
- 2 The DHCP server assigns automatically an IP address.
Precondition: DHCP = ON
- 3 Search for the VGC094 in the network using the Ethernet Configuration Tool and assign it to a virtual COM interface (→ 102).
- 4 Start the program for communication with the VGC094 and connect it to the assigned COM interface.

Computer without DHCP server

- 1 Save all VGC094 parameters on a USB memory stick ("SAVE SETUP", → 47).
- 2 Set the following Ethernet parameters in the saved CSV file on the memory stick:

IP ADDRESS:	192.168.0.1 (192.168.0.2 for a second unit, and so on)
NETMASK:	255.255.0.0
DHCP:	OFF
- 3 Load the modified parameters onto the VGC094 ("RESTORE SETUP", → 47).

- 4 Connect the VGC094 to a computer ...
 - with a crossover Ethernet cable,
 - via a switch, or
 - with an Ethernet patch cable (precondition: the interface is auto MDI-X capable).
- 5 Search for the VGC094 in the network using the Ethernet Configuration Tool and assign it to a virtual COM interface (→ 102).
- 6 Start the program for communication with the VGC094 and connect it to the assigned COM interface.

D 3: Ethernet Configuration Tool

With the Ethernet Configuration Tool, a virtual serial interface (COM) can be assigned to an IP address. In addition, it allows configuration of the Ethernet interface via a computer.

Precondition: Windows 7, 8 or 10 operating system (does not work on Windows XP)

- 1 Download the Ethernet Configuration Tool from our website "www.inficon.com" or copy it from the enclosed CD ROM.
- 2 Start the Ethernet Configuration Tool and click on <Search Devices>: The tool searches the local network for connected devices and lists the devices found in the selection window. The <Device Info> tab page shows basic information about the selected device.

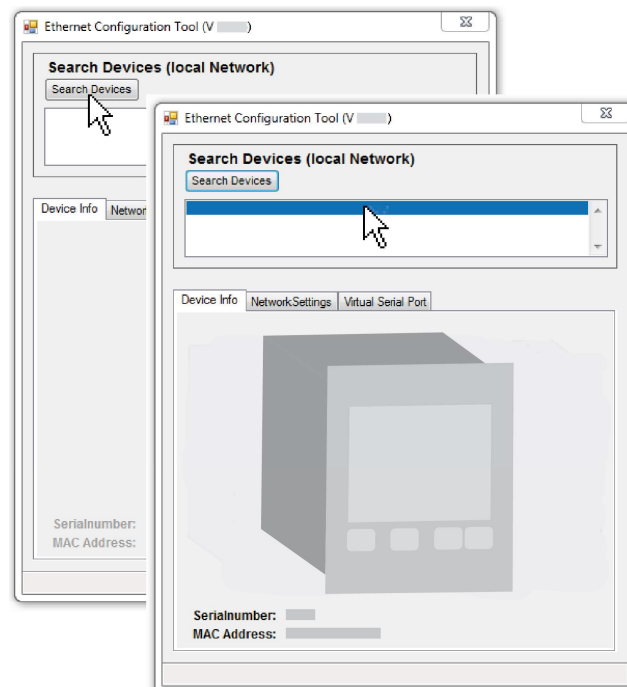

- 3 The <Network Settings> tab page is where the automatic or manual network settings are configured.

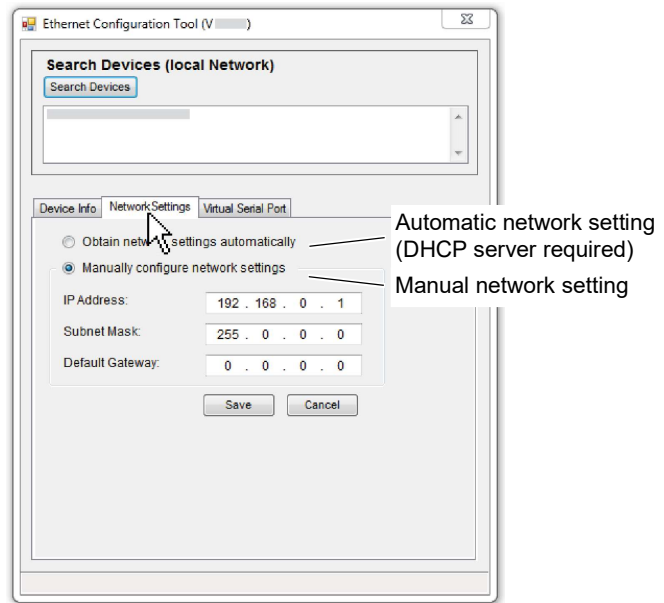



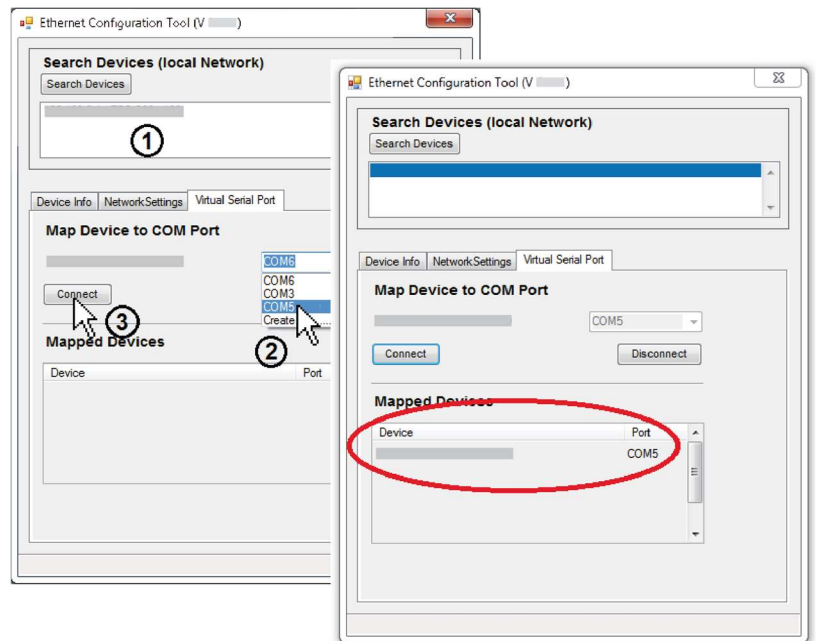

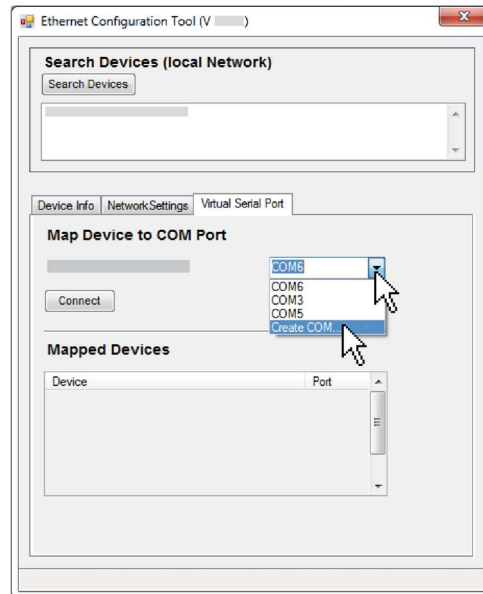

- 4 On the <Virtual Serial Port> tab page, you can assign a separate COM Port to each device, and/or ...



... generate a new COM Port.



E: Literature

-  [1] Operating Manual
 Plug-In Boards for Total Pressure Gauge Controller TPG300, VGC094
 IG5972BEN
 INFICON AG, LI-9496 Balzers, Liechtenstein
-  [2] Operating Manual
 Pirani Gauges PSG010, PSG017, PSG018
 tinb71e1
 INFICON AG, LI-9496 Balzers, Liechtenstein
-  [3] Operating Manual
 Cold Cathode Gauge MAG050, MAG060, MAG070
 tinb43e1
 INFICON AG, LI-9496 Balzers, Liechtenstein
-  [4] Operating Manual
 Cold Cathode Gauge MAG084
 tinb81e1
 INFICON AG, LI-9496 Balzers, Liechtenstein
-  [5] Communication protocol
 Profibus-DP Interface Board for Total Pressure Gauge Controller
 TPG300, VGC094
 IG3973BEN
 INFICON AG, LI-9496 Balzers, Liechtenstein
-  [6] Communication protocol
 Profinet Interface Board for Total Pressure Gauge Controller VGC094
 tirb68e1
 INFICON AG, LI-9496 Balzers, Liechtenstein

ETL Certification



ETL LISTED

The product VGC094

- conforms to the UL Standards UL 61010-1:2012 Ed.3+R:19Jul2019 and UL 61010-2-030:2012 Ed.1 +R:16Sep2016
- is certified to the CAN/CSA Standards CSA C22.2#61010-1-12:2012 Ed.3 +U1;U2;A1 and CSA C22.2#61010-2-030:2018 Ed.2

EU Declaration of Conformity



We, INFICON, hereby declare that the equipment mentioned below complies with the provisions of the following directives:

- 2014/35/EU, OJ L 96/357, 29.3.2014
(Low Voltage Directive; Directive relating to electrical equipment designed for use within certain voltage limits)
- 2014/30/EU, OJ L 96/79, 29.3.2014
(EMC Directive; Directive relating to electromagnetic compatibility)
- 2011/65/EU, OJ L 174/88, 1.7.2011
(RoHS Directive; Directive on the restriction of the use of certain hazardous substances in electrical and electronic equipment)

Product

Vacuum Measurement and Control Unit for Compact Gauges
VGC094

Standards

Harmonized and international/national standards and specifications:

- EN 61000-3-2:2014, Class A
(EMC: limits for harmonic current emissions)
- EN 61000-3-3:2013
(EMC: limitation of voltage changes, voltage fluctuations and flicker)
- EN 61000-6-1:2007
(EMC: generic immunity for residential, commercial and light-industrial environments)
- EN 61000-6-2:2005
(EMC: generic immunity standard for industrial environments)
- EN 61000-6-4:2007 + A1:2011
(EMC: generic emission standard for industrial environments)
- EN 61010-1:2010 + A1:2019
(Safety requirements for electrical equipment for measurement, control and laboratory use)
- EN 61010-2-030:2010
(Safety requirements for electrical equipment for measurement, control and laboratory use)
- EN 61326-1:2013; Group 1, Class A
(EMC requirements for electrical equipment for measurement, control and laboratory use)

Manufacturer / Signatures

INFICON AG, Alte Landstraße 6, LI-9496 Balzers

29 July 2020

29 July 2020



Dr. Christian Riesch
Head of Development



Denis Hari
Product Manager

Notes

Original: German tinb68d1 (2021-11)



tinb68e1



LI-9496 Balzers
Liechtenstein
Tel +423 / 388 3111
Fax +423 / 388 3700
reachus@inficon.com

www.inficon.com