

Pirani Gauge

PSG010, PSG017, PSG018

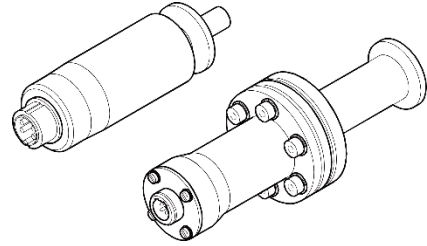

CE Operating Manual
Incl. EU Declaration of Conformity
tinb71e1-b (2024-09)

Product Identification

In all communications with INFICON, please specify the information given on the product nameplate. For convenient reference copy that information into the space provided below.

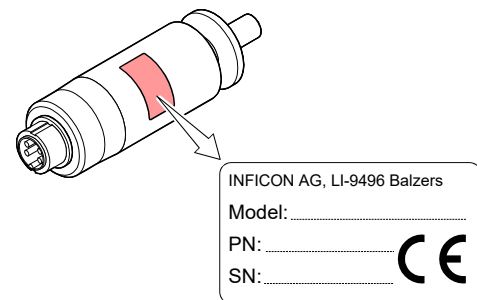

Validity

This document applies to products with the following part numbers:

PSG010 (W filament)	350-400	(DN 10 ISO-KF)
PSG017 (Ni filament)	350-430 350-431	PSG018 (W filament) 350-420 (DN 16 ISO-KF) 350-424 (DN 16 CF-F) 350-423 (DN 40 CF-F)

The part number (PN) can be taken from the product nameplate.

We reserve the right to make technical changes without prior notice.

All dimensions are indicated in mm.

Intended Use

The Pirani Gauges PSG010, PSG017 and PSG018 have been designed for vacuum measurement of gases in the pressure range of 8×10^{-4} ... 1000 mbar.

They must not be used for measuring flammable or combustible gases in mixtures containing oxidants (e.g. atmospheric oxygen) within the explosion range.

The gauges can be operated in connection with the INFICON VGC094 total pressure gauge controller.

Safety

Symbols Used

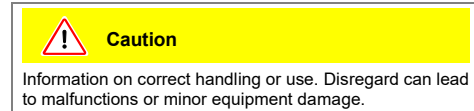
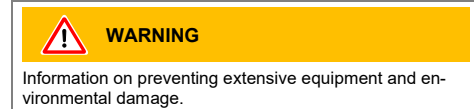
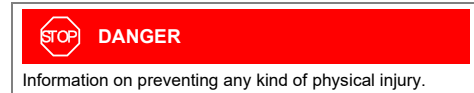

Personnel Qualifications

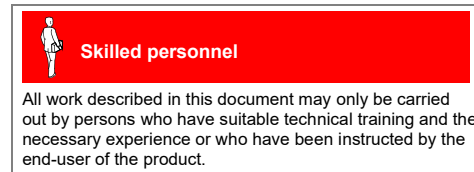

General Safety Instructions

- Adhere to the applicable regulations and take the necessary precautions for the process media used. Consider possible reactions with the product materials. Consider possible reactions (e.g. explosion) of the process media due to the heat generated by the product.
- Adhere to the applicable regulations and take the necessary precautions for all work you are going to do and consider the safety instructions in this document.
- Before beginning to work, find out whether any vacuum components are contaminated. Adhere to the relevant regulations and take the necessary precautions when handling contaminated parts.

Communicate the safety instructions to all other users.

Liability and Warranty

INFICON assumes no liability and the warranty becomes null and void if the end-user or third parties

- disregard the information in this document
- use the product in a non-conforming manner
- make any kind of changes (modifications, alterations etc.) to the product
- use the product with accessories not listed in the product documentation.

The end-user assumes the responsibility in conjunction with the process media used.

Gauge failures due to contamination or wear and tear, as well as expendable parts (filament), are not covered by the warranty.

Technical Data

Measurement principle	thermal conductance according to Pirani
Measurement range (air, O ₂ , CO, N ₂)	8×10^{-4} ... 1000 mbar
Accuracy PSG010	up to factor 2 of reading in the range of ≥ 100 mbar $\approx \pm 20\%$ of reading in the range of 1×10^{-1} ... 10 mbar up to factor 2 of reading in the range of $\leq 10^{-2}$ mbar
Accuracy PSG018	At room temperature and cable length <20m $\approx \pm 10\%$ of reading in the range of 1×10^{-2} ... 100 mbar At 0 ... +70°C and within the entire range of specified cable length $\approx \pm 20\%$ of reading in the range of 1×10^{-2} ... 100 mbar Within the entire specified range of temperatures and cable length $\approx \pm 35\%$ of reading in the range of 1×10^{-2} ... 100 mbar
Repeatability with air	PSG010, PSG017 $\approx \pm 2\%$ of reading in the range of 1×10^{-2} ... 100 mbar PSG018 $\approx \pm 5\%$ of reading in the range of 1×10^{-2} ... 100 mbar

Materials PSG010	Inside wall of measurement chamber, flange, electrical feedthrough, Filter, Filament / filament holder	AlMgSi, FPM, sintered bronze, W / Ni
Materials PSG017	Inside wall of measurement chamber, flange, diaphragm, electrical feedthrough, Filament / filament holder	stainless steel, Al ₂ O ₃ , Ni / Ni
Materials PSG018	Inside wall of measurement chamber, flange, diaphragm, electrical feedthrough, Filament / filament holder	stainless steel, Al ₂ O ₃ , W / Ni

Radiation resistance	PSG010: - PSG017, PSG018: 1×10^6 Gy
Overpressure	≤ 9 bar (limited to inert gases)
Cable length	depending on the measurement unit

Admissible Temperatures	Operation PSG010: 0 ... +70°C PSG017: 0 ... +120 °C ¹⁾ PSG018: 0 ... +120 °C ¹⁾ Bakeout PSG010: +100 °C PSG017, PSG018: +250 °C ²⁾ Filament PSG010, PSG018: +130 °C PSG017: +70 °C Storage: -40 ... +80 °C
-------------------------	---

Relative humidity	$\leq 80\%$ at temperatures $\leq +31$ °C, decreasing to 50% at +40 °C
Mounting orientation	any
Use	indoors only altitudes up to 2000 m
Pollution degree	2
Protection category	IP40

Dimensions [mm]	PSG010
-----------------	--------

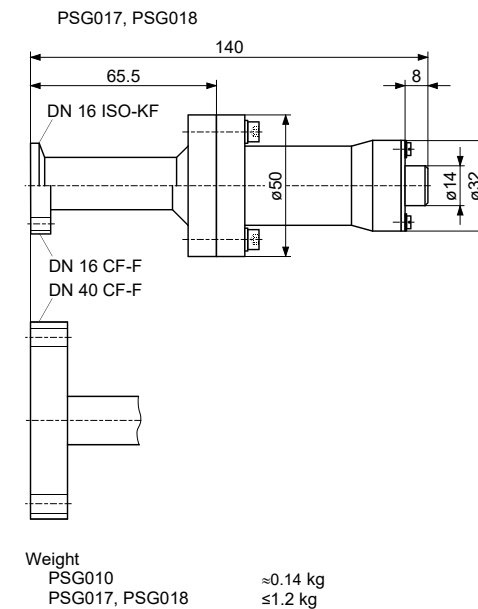
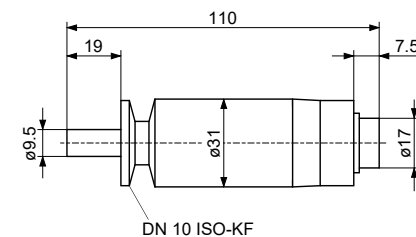

Gas Type Dependence

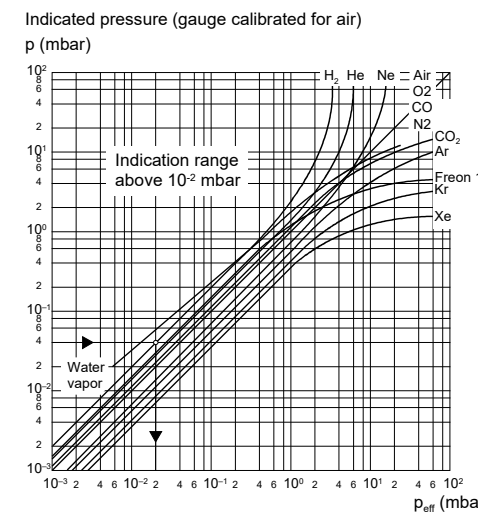

Calibration factors for pressure range below 1 mbar

$$p_{\text{eff}} = C \times \text{indicated pressure}$$

Gas type	Calibration factor C	Gas type	Calibration factor C
He	0.8	H ₂	0.5
Ne	1.4	air, O ₂ , CO, N ₂	1.0
Ar	1.7	CO ₂	0.9
Kr	2.4	water vapor	0.5
Xe	3.0	Freon 12	0.7

Installation

Vacuum Connection

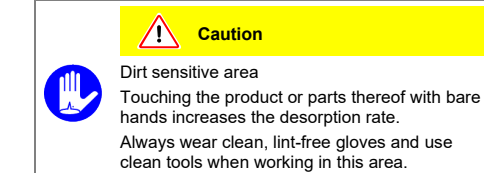
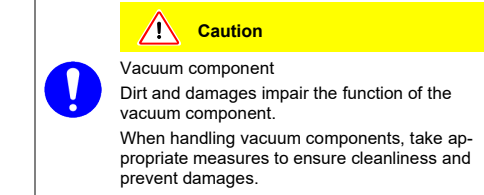
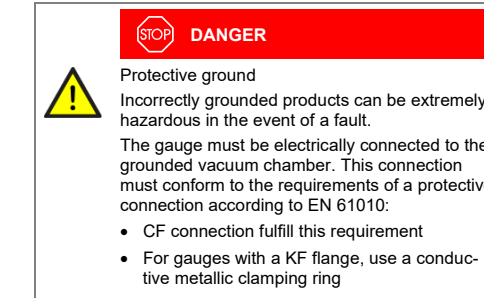
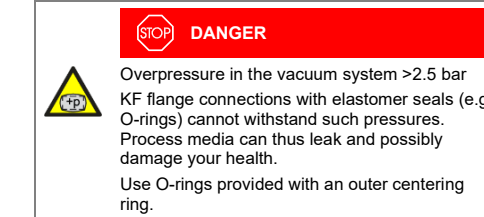
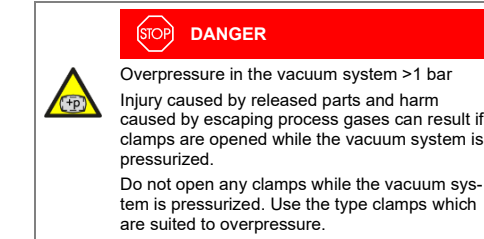
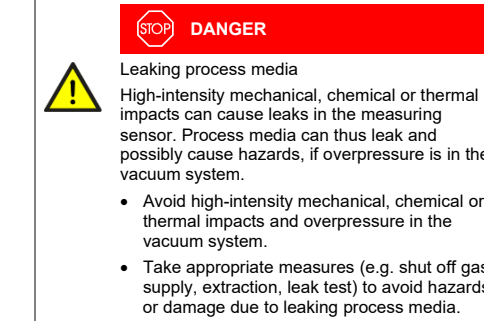

The gauge may be mounted in any orientation. To keep condensates and particles from getting into the measuring chamber preferably choose a horizontal to upright position.

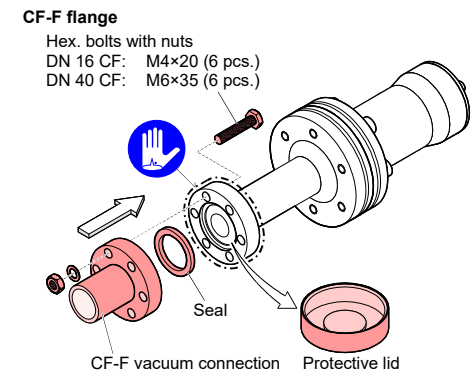
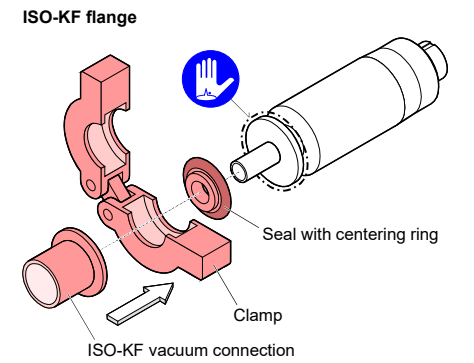

Power Connection

Before connecting or disconnecting the product, turn off the control system.

The gauge is connected to the controller via a measurement cable (→ "Accessories").

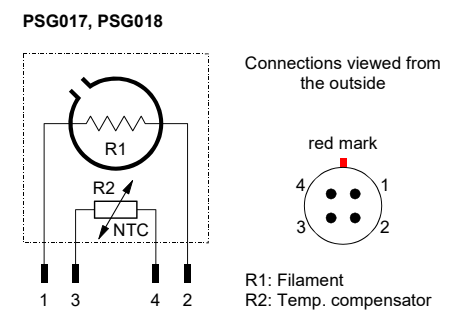
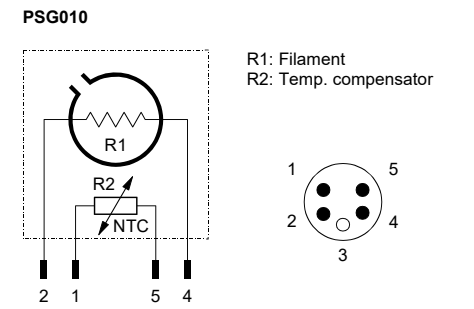

¹⁾ With high-temperature cable.

²⁾ With high-temperature cable or without cable.

Operation

After connection the gauge is ready for operation.

 When the gauge is operated for the first time, a zero adjustment should be performed.

It is advisable to operate the gauge continuously, irrespective of the pressure.

PSG017 and PSG018: If the diaphragm is removed in order to achieve shorter response times, sudden pressure changes should be avoided in order to protect the filament.

The sensitivity of the nickel filament of the PSG017 gauge is not the same as the sensitivity of the tungsten filament of the PSG010 and PSG018 gauges.

 Measurement cables influence the accuracy of measurement. If cables with lengths over 20 m are used, we strongly recommend adjusting the gauge together with the cable. For details refer to the operating instructions of the corresponding controller.

Adjustment

The gauge is factory calibrated. For most applications, it needs to be realigned. This allows to correct measurement errors caused by spread between units, temperature and the influence of the cable length. The gauge is aligned according to the operating instructions of the measurement unit used.

For adjusting the gauge, operate the gauge under the same ambient conditions and in the same mounting orientation as normally.

Gas Type Dependence

The measurement value is gas dependent. The reading applies to dry air, N₂, O₂ and CO. For other gases, it has to be converted (→ Technical Data and operating instructions of the corresponding controller).

In the pressure range below 1 mbar this can be done by entering the corresponding calibration factor on the controller (→ Operating instructions of the corresponding controller).

Deinstallation

STOP DANGER

 Contaminated parts
Contaminated parts can be detrimental to health and environment.
Before beginning to work, find out whether any parts are contaminated. Adhere to the relevant regulations and take the necessary precautions when handling contaminated parts.

Caution

 Vacuum component
Dirt and damages impair the function of the vacuum component.
When handling vacuum components, take appropriate measures to ensure cleanliness and prevent damages.

Caution

 Dirt sensitive area
Touching the product or parts thereof with bare hands increases the desorption rate.
Always wear clean, lint-free gloves and use clean tools when working in this area.

- 1** Vent the vacuum system.
- 2** Put the gauge out of operation.
- 3** Unplug the sensor cable.
 Before connecting or disconnecting the product, turn off the control system.
- 4** Remove the gauge from the vacuum system and cover the vacuum connection with the protective lid.

Maintenance, Troubleshooting

 Gauge failures due to contamination or wear and tear, as well as expendable parts (filament), are not covered by the warranty.

Realignment at the measurement unit can become necessary in the following events:

- Altering
- Contamination
- After cleaning

Cleaning

STOP DANGER

 Contaminated parts
Contaminated parts can be detrimental to health and environment.
Before beginning to work, find out whether any parts are contaminated. Adhere to the relevant regulations and take the necessary precautions when handling contaminated parts.

Caution

 Vacuum component
Dirt and damages impair the function of the vacuum component.
When handling vacuum components, take appropriate measures to ensure cleanliness and prevent damages.

Caution

 Dirt sensitive area
Touching the product or parts thereof with bare hands increases the desorption rate.
Always wear clean, lint-free gloves and use clean tools when working in this area.

Precondition: Gauge deinstalled

- 1** Clean or replace the filter (PSG010) ...

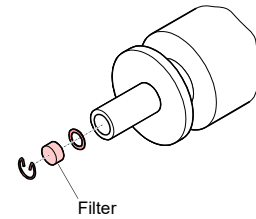

... or clean the diaphragm (PSG017, PSG018).

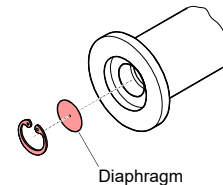

- 2** Clean the gauge / replace parts.

STOP DANGER

 Cleaning agents
Cleaning agents can be detrimental to health and environment.
Adhere to the relevant regulations and take the necessary precautions when handling and disposing of cleaning agents. Consider possible reactions with the product materials (see "Technical data").

- Fill the measurement chamber with a solvent and allow it to work for some time. Repeat this procedure if necessary.
- Pour the solvent out.
- Rinse the vacuum chamber and the filter with alcohol for several times in order to remove all solvent residues.
- Dry at ≈70 °C.

- 3** Insert the filter (PSG010), resp. diaphragm (PSG017, PSG018).

Troubleshooting

Fault	Possible cause	Remedy
Pressure readings supplied by gauge too high	Gauge contaminated	Minor deviations can be compensated by realignment at the measurement unit Clean the gauge
	Filter contaminated (PSG010)	Clean or replace it
No useful indication	Filament broken (an unbroken filament has a resistance of ≈100 Ω)	Replace the gauge
	Gauge cable defective, interrupted, or short-circuit	Repair or replace the cable

Spare Parts

	Ordering No.
Filter	B 4161 2003 G

Storage

Caution

 Vacuum component
Inappropriate storage leads to an increase of the desorption rate and/or may result in mechanical damage of the product.
Cover the vacuum ports of the product with protective lids or grease free aluminum foil. Do not exceed the admissible storage temperature range (→ "Technical Data")

Returning the Product

WARNING

 Forwarding contaminated products
Contaminated products (e.g. radioactive, toxic, caustic or microbiological hazard) can be detrimental to health and environment.
Products returned to INFICON should preferably be free of harmful substances. Adhere to the forwarding regulations of all involved countries and forwarding companies and enclose a duly completed declaration of contamination ¹⁾.

¹⁾ Form under www.inficon.com

Products that are not clearly declared as "free of harmful substances" are decontaminated at the expense of the customer.

Products not accompanied by a duly completed declaration of contamination are returned to the sender at his own expense.

Disposal

STOP DANGER

 Contaminated parts
Contaminated parts can be detrimental to health and environment.
Before beginning to work, find out whether any parts are contaminated. Adhere to the relevant regulations and take the necessary precautions when handling contaminated parts.

WARNING

 Substances detrimental to the environment
Products or parts thereof (mechanical and electric components, operating fluids etc.) can be detrimental to the environment.
Dispose of such substances in accordance with the relevant local regulations.

Separating the components

After disassembling the product, separate its components according to the following criteria:

- Contaminated components
Contaminated components (radioactive, toxic, caustic, or biological hazard etc.) must be decontaminated in accordance with the relevant national regulations, separated according to their materials, and recycled.
- Other components
Such components must be separated according to their materials and recycled.

Literature

- [1] www.inficon.com
Operating Manual
VGC094
tinb68e1
INFICON AG, LI-0496 Balzers, Liechtenstein

EU & UKCA Declaration of Conformity



We, INFICON, hereby declare that the equipment mentioned below comply with the provisions of the following EU directives and UK regulations:

- 2014/35/EU, OJ L 96/357, 29.3.2014 (LV Directive; directive relating to electrical equipment designed for use within certain voltage limit)
- 2014/30/EU, OJ L 96/79, 29.3.2014 (EMC Directive; directive relating to electromagnetic compatibility)
- 2011/65/EU, OJ L 174/88, 1.7.2011 (RoHS Directive; directive on the restriction of the use of certain hazardous substances in electrical and electronic equipment)
- S.I. 2016/1101, 11.2016 (The electrical equipment (safety) regulations 2016)
- S.I. 2016/1091, 11.2016 (The electromagnetic compatibility regulations 2016)
- S.I. 2012/3032, 12.2012 (The restriction of the use of certain hazardous substances in electrical and electronic equipment regulations 2012)

Products

Pirani Gauge

PSG010, PSG017, PSG018
(Operation with VGC094)

Standards

Harmonized and international/national standards and specifications:

- EN 61000-3-2:2014, Class A (EMC: limits for harmonic current emissions)
- EN 61000-3-3:2013 (EMC: limitation of voltage changes, voltage fluctuations and flicker)
- EN 61000-6-1:2007 (EMC: generic immunity for residential, commercial and light-industrial environments)
- EN 61000-6-2:2005 (EMC: generic immunity standard for industrial environments)
- EN 61000-6-4:2007 + A1:2011 (EMC: generic emission standard)
- EN 61010-1:2010 + A1:2019 + A1:2019/AC:2019 (Safety requirements for electrical equipment for measurement, control and laboratory use)
- EN 61010-2-030:2010 (Safety requirements for electrical equipment for measurement, control and laboratory use)
- EN 61326-1:2013; Group 1, Class A (EMC requirements for electrical equipment for measurement, control and laboratory use)

Manufacturer / Signatures

INFICON AG, Alte Landstraße 6, LI-9496 Balzers

26 July 2023

26 July 2023

Rolf Enderes *Roberto Salemma*

Rolf Enderes
Director Development &
Software

Dr. Roberto Salemma
Product Manager



LI-9496 Balzers
Liechtenstein
Tel +423 / 388 3111
Fax +423 / 388 3700
reachus@inficon.com
www.inficon.com